



STELVIO

OWNER HANDBOOK

Dear Customer,

We would like to congratulate and thank you for choosing an Alfa Romeo.

We have written this handbook to help you get to know all the features of your car and use it in the best possible way. This car is intended for daily use as well as for specific uses. Please take your time to familiarise with all the dynamic features of your car.

Here you will find information, advice and important warnings regarding use of your car and how to achieve the best performance from the technical features of your Alfa Romeo.

You are advised to read it right through before taking to the road for the first time, to become familiar with the controls and above all with those concerning brakes, steering and transmission; at the same time, you can understand the car behaviour on different road surfaces.

This document also provides a description of special features and tips, as well as essential information for the safe driving, care and maintenance of your Alfa Romeo over time.

In the attached Warranty Booklet you will also find the description of the Services that Alfa Romeo offers to its customers, the Warranty Certificate and the detail of the terms and conditions for maintaining its validity.

We are confident that these will bring you closer to your new car and make you appreciate the assistance provided by Alfa Romeo team.

Enjoy reading. Happy driving!

WARNING

This Owner Handbook describes all car versions. Options, equipment dedicated to specific Markets or versions are not explicitly indicated in the text: as a consequence, you should only consider the information related to the version that you have purchased. Any content introduced throughout the production of the model, outside the specific request of options at the time of purchase, will be identified with the wording (*where provided*).

The data contained in this publication should be understood as intended to guide you in the correct use of the car.

Alfa Romeo S.p.A. aims at a constant improvement of the vehicles produced. For this reason it reserves the right to make changes to the model described for technical and/or commercial reasons.

For further information, contact an Alfa Romeo Dealership.

READ THIS CAREFULLY

REFUELLING



Petrol engines: only refuel with unleaded petrol with octane rating (RON) not less than 95 in compliance with the European specification EN228. Do not use petrol containing methanol or ethanol E85. Using these mixtures may cause misfiring and driving issues, as well as damage vital components of the supply system.

Diesel engines: refuel only with Diesel fuel motor vehicles conforming to the European specification EN590. The use of other products or mixtures may damage the engine beyond repair and consequently invalidate the warranty, due to the damage caused.

For further details on the use of the correct fuel see the "Refuelling the car" chapter in the "Starting and driving" section.

STARTING THE ENGINE



Make sure that the electric parking brake is engaged and that the transmission is in P (Park) or N (Neutral), press the brake pedal and then press the ignition device button.

PARKING ON FLAMMABLE MATERIAL



The catalytic converter develops high temperatures during operation. Do not park the car on grass, dry leaves, pine needles or other flammable material: fire hazard.

RESPECTING THE ENVIRONMENT



The vehicle is fitted with a system that carries out a continuous diagnosis of the emission-related components in order to help protect the environment.

ELECTRICAL ACCESSORIES



If, after buying the vehicle, you decide to add electrical accessories (with the risk of gradually draining the battery), contact an Alfa Romeo Dealership. They can calculate the overall electrical requirement and check that the vehicle's electric system can support the required load.

SCHEDULED SERVICING



Correct maintenance of the car is essential for ensuring that it maintains its performance and its safety features, its environmental friendliness and low running costs for a long time to come.

“CYBERSECURITY” DEVICES

The car is equipped with security devices developed according to the technological standards currently applied in the automotive industry to protect the onboard electronic systems from hacking attempts. The purpose of these security devices is to minimise the risk of cyber-attacks or the installation of viruses or malware which could compromise the performance of the car and/or allow stealing of personal data of the buyers and/or users and/or unauthorised dissemination of said information.

The car's purchaser must not remove, modify or tamper with these anti-hacking security devices. The Manufacturer will therefore not be liable for negative consequences and/or damage to the vehicle and/or to the buyer and/or to third parties deriving from the removal, modification or alteration of the security devices performed by the car's purchaser and/or user.

CHANGES/ALTERATIONS TO THE CAR

WARNING

WARNING Any change or alteration of the car might seriously affect its safety and road holding, thus causing accidents, in which the occupants could even be fatally injured.

ACCESSORIES PURCHASED BY THE OWNER

If after buying the vehicle, you decide to install electrical accessories that require a permanent electrical supply (e.g. radio, satellite anti-theft system, etc.) or accessories that in any case burden the electrical supply, contact an Alfa Romeo Dealership, whose personnel will check whether the vehicle's electrical system is able to withstand the load required, or whether it needs to be integrated with a more powerful battery.

WARNING Take care when fitting additional spoilers, alloy wheel rims or non-standard wheel hubs: they could reduce the ventilation of the brakes and affect efficiency under sharp, repeated braking or on long descents. Make sure that nothing obstructs the pedal stroke (mats, etc.).

Alfa Romeo S.p.A. shall not be liable for damage caused by the installation of accessories either not supplied or recommended by Alfa Romeo S.p.A. and/or not installed in compliance with the provided instructions.

INSTALLING ELECTRICAL/ELECTRONIC DEVICES

Electrical and electronic devices installed after buying the car in the context of after-sales service must carry the following label :

Alfa Romeo S.p.A. authorises the installation of transceivers provided that installation is carried out at a specialised centre, in a workmanlike fashion and in compliance with manufacturer's specifications.

WARNING Traffic police may not allow the vehicle on the road if devices have been installed which modify the features of the vehicle. This may also cause invalidation of warranty in relation to faults caused by the change either directly or indirectly related to it.

Alfa Romeo S.p.A. shall not be liable for damage caused by the installation of accessories either not supplied or recommended by Alfa Romeo S.p.A. and/or not installed in compliance with the provided instructions.

RADIO TRANSMITTERS AND MOBILE PHONES

Radio transmitter equipment (car mobile phones, CB radios, amateur radio etc.) cannot be used inside the car unless a separate aerial is mounted on the roof.

Transmission and reception of these devices may be affected by the shielding effect of the car body.

As far as the use of EC-approved mobile phones is concerned (GSM, GPRS, UMTS, LTE), follow the usage instructions provided by the mobile phone Manufacturer.

WARNING The use of these devices inside the passenger compartment (without an external aerial) may cause the electrical systems to malfunction. This could compromise the safety of the car in addition to constituting a potential hazard for passengers' health.

WARNING If mobile phones/laptops/smartphones/tablets are inside the car and/or close to the electronic key, a reduced performance of the Passive Entry/Keyless Start system may occur.

USE OF THE OWNER HANDBOOK

OPERATING INSTRUCTIONS

Each time an instruction is given that concerns direction (left/right or forward/backward), it is written to be read from the perspective of an occupant in the driver's seat. If a direction is written from a different perspective, it will be specified as such in the text as appropriate.

The figures in the Owner Handbook are provided by way of example only: this might imply that some details of the image do not correspond to the actual arrangement of your car. In addition, the Handbook has been conceived considering vehicles with steering wheel on the right side; therefore the position or construction of some controls is not exactly mirror-like with respect to the figure.

To identify the section with the information needed you can consult the index at the end of this Owner Handbook.

The sections can be rapidly identified with dedicated graphic tabs, at the side of each odd page. A few pages further there is a key for getting to know the section order and the relevant symbols in the tabs. Additionally, there is a textual indication of each current section at the side of each even page.

WARNINGS AND CAUTIONS

While reading this Owner Handbook you will find a series of **WARNINGS** to prevent procedures that could damage your car.

There are also **CAUTIONS** that must be carefully followed to prevent incorrect use of the components of the car, which could cause accidents or injuries.

Therefore, all **WARNINGS** and **CAUTIONS** must always be carefully followed.

WARNINGS and **CAUTIONS** are recalled in the text with the following symbols:

 personal safety;

 car safety;

 environmental protection.

NOTE These symbols, when necessary, are indicated besides the title or at the end of the line and are followed by a number.

That number recalls the corresponding warning at the end of the relevant section.

SYMBOLS

Some car components have coloured labels whose symbols indicate precautions to be observed when using this component. See below for a brief description of each symbol summarising the contents herein. Always take great care to all warnings herein.



READ THE USER'S
MANUAL



DO NOT TOUCH WITH
HANDS



IT CAN START
AUTOMATICALLY ALSO
WITH ENGINE OFF



PROTECT YOUR EYES



DO NOT OPEN THE CAP
WHEN THE ENGINE IS
HOT



DO NOT OPEN: HIGH
PRESSURE GAS



KEEP CHILDREN AT A
DISTANCE



BURSTING

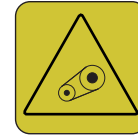

MOVING PARTS KEEP
PARTS OF YOUR BODY
AND CLOTHES AWAY



DO NOT APPROACH
FLAMES



CORROSIVE LIQUID

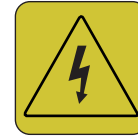

HIGH VOLTAGE

Blank page

GETTING TO KNOW YOUR CAR



KNOWING THE INSTRUMENT PANEL



SAFETY



STARTING AND DRIVING



IN AN EMERGENCY



MAINTENANCE AND CARE



TECHNICAL SPECIFICATIONS



MULTIMEDIA



CONTENTS

ABC



GETTING TO KNOW YOUR CAR

- DASHBOARD12
- THE KEYS13
- IGNITION DEVICE15
- ENGINE IMMOBILIZER16
- ALARM17
- DOORS18
- SEATS22
- HEAD RESTRAINTS26
- STEERING WHEEL27
- REAR-VIEW MIRRORS28
- EXTERNAL LIGHTS30
- INTERIOR LIGHTS35
- WINDSCREEN WIPER36
- CLIMATE CONTROL SYSTEM38
- ELECTRIC WINDOWS43
- ELECTRIC SUNROOF44
- BONNET45
- TAILGATE46
- INTERIOR FITTINGS48
- WIRELESS CHARGING SYSTEM - WCPM (Wireless Charge Pad Module)50
- ENVIRONMENTAL PROTECTION SYSTEMS51

In-depth knowledge of your new car starts here. The handbook you are reading will tell you how things are done, and how it works in a simple, direct way. That's why we advise you to read it seated comfortably on board, so that you can see immediately what is described here for yourself.

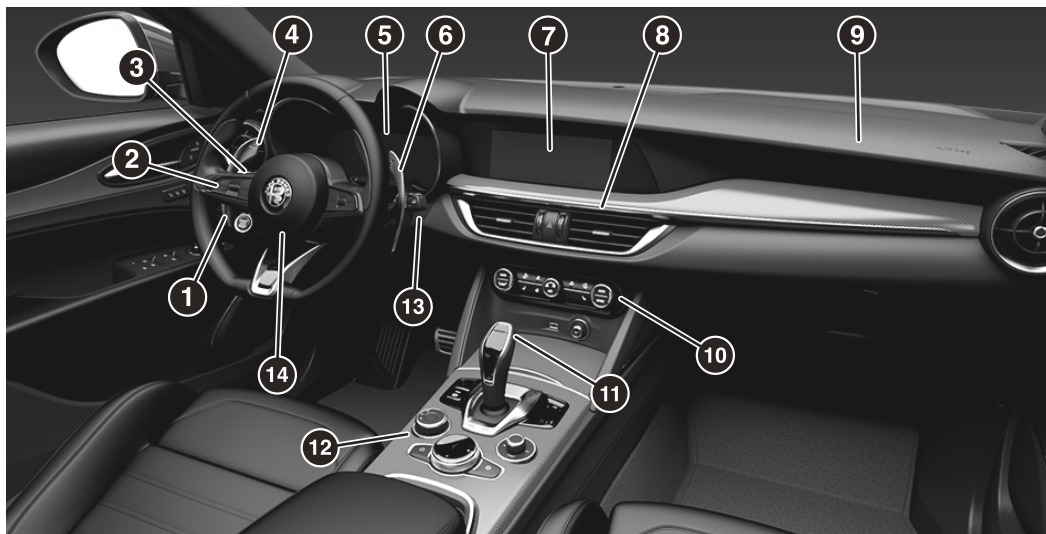
DASHBOARD

I

9490100

1 Exterior light switch / 2 Steering wheel controls: Cruise Control (where provided) / Active Cruise Control (where provided) / HAS system (where provided) / TSR system (where provided) / TJA system (where provided) / ISC system (where provided) / 3 Left stalk (external lights) / 4 Automatic transmission left shift paddle / 5 Instrument panel display / 6 Automatic transmission right shift paddle / 7 Connect system / 8 Central air vents / 9 Passenger front airbag / 10 Automatic dual-zone climate control system / 11 Automatic transmission lever / 12 Controls on central tunnel (Alfa DNA™ Pro / Rotary Pad and interaction with Connect system) / 13 Right stalk (wiper) / 14 Steering wheel - Driver front airbag

THE KEYS

ELECTRONIC KEY



The car is equipped with an electronic key with a Keyless Start function fig. 2, provided in duplicate.



2

0401650010EM

OPERATION

Unlocking the doors and the tailgate

Briefly press the  button: unlocking of doors and tailgate, timed switching-on of ceiling lights and single flashing of direction indicators (if activated from the Connect system).

When the function is available, press and release the unlock button on the remote control once only to unlock the driver's door or twice within 1 second to unlock all doors and the tailgate.

It is however possible to change the current setting through the Connect

system menu, so that the system unlocks:

- all doors on the first press of the remote control button;
- only the driver door on the first press of the remote control button (where provided);
- the tailgate, "independently" or "with doors".

Moreover, the Connect system can be used to activate or deactivate the flashing of the direction indicators upon locking/unlocking the doors and activate the "courtesy light" function (dipped beam headlights and direction indicators switch on) upon unlocking the doors. For further information, see paragraph "Settings" in the "Connect" supplement.

The doors can always be unlocked by putting the metal insert inside the driver side door lock.

Door and tailgate locking

Briefly press the  button: locking of doors and tailgate, timed switching-off of ceiling lights and double flashing of direction indicators (if activated from Connect system).

If one or more doors are open, the doors are locked and this is indicated by a rapid flashing of the direction indicators (where provided). The doors prepare for locking, which is active from the moment they are closed. The doors will unlock

again only if the key presence is detected inside the passenger compartment.

The doors can always be locked by putting the metal insert inside the driver side door lock.

Automatic window opening/closing function

(where provided)

Prolonged pressing of button : open all windows.

Prolonged pressing of button : close all windows.

Tailgate opening

Rapidly press the  button twice to open the tailgate remotely. The direction indicators will flash twice to indicate that the tailgate has been opened.

REPLACING THE ELECTRONIC KEY BATTERY



To replace the battery, proceed as follows:

- press in the points shown fig. 3 and slide the cover off downwards;
- remove the key insert fig. 4;



ABC



3

0401650002EM

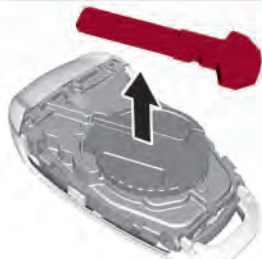

4

0401650003EM

- remove the battery cap fig. 5 by rotating it anticlockwise;
- remove the battery from its housing fig. 6 and replace it with a new one of the same type.

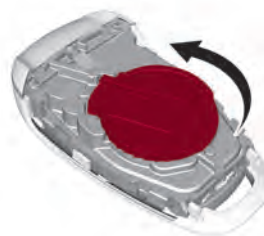

5

0401650004EM



6

0401650005EM

Proceed in reverse order to reassemble the key.

WARNING The battery replacement operation must be carried out with care, in order not to damage the electronic key.

REQUEST FOR ADDITIONAL KEYS

The system can recognise up to 8 keys with remote control.

Only use keys that have been specially coded for the car electronics.

If an electronic key is coded for a car, it cannot be used on any other car.

Duplicating keys

If you need a new electronic key, go to an Alfa Romeo Dealership, taking an ID document and the car ownership documents.



WARNING

1) Do not swallow the battery. Danger of chemical burns. The keys contain a small battery. If the battery is swallowed, it can cause severe internal burns in just 2 hours and cause death. Keep new and used batteries out of the reach of children. If the battery compartment does not close securely, discontinue use of the product and keep it out of reach of children. If you believe that batteries may have been swallowed or inserted inside the body, seek medical attention immediately. The emergency key (where provided) must be immediately inserted into the electronic key to prevent easy access to the battery.



IMPORTANT

1) The electronic components inside the key may be damaged if the key is subjected to strong shocks. In order to ensure complete efficiency of the electronic devices inside the key, it should never be exposed to direct sunlight.



IMPORTANT

1) Used batteries may be harmful to the environment if not disposed of correctly. They must be disposed of as specified by law in the special containers or taken to an Alfa Romeo Dealership, which will take care of their disposal.

IGNITION DEVICE

OPERATION

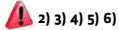

To activate the ignition device fig. 7 the electronic key must be inside the passenger compartment.



7

04026V0001EM

The ignition device has the following possible states:

□ STOP: engine off, steering column locked. Some electrical devices (e.g. central door locking system, alarm, etc.) are still available;

□ ON (single button press): all electrical devices are available. This state can be selected by pressing the ignition device button once, without pressing the brake pedal;

□ AVV: engine starting. This state can be selected by pressing the ignition device button once and pressing the brake pedal.

After starting the engine, insert the electronic key into housing 1 fig. 8 beside the shift lever on the central tunnel.



8

04206S0554EM

NOTE With the ignition device ON, if 30 minutes pass with P (Park) mode

engaged and the engine off, the ignition device will automatically move to the STOP position.

NOTE With motor started, it is possible to go away from the car taking the electronic key with you. The engine will still be running. The car will indicate the absence of the key on board when the door is closed.

WARNING If the battery was disconnected, do not start the engine immediately after reconnecting the terminals, but press the start button, without operating the pedals, to turn on the instrument panel and then start the engine.

The  symbol on the instrument panel will remain on, indicating that the steering must be initialised. To do this, turn the steering wheel from one end to the other and bring it back to the centre position within 30 seconds from starting the engine. If faults persist (warning lights appearing on the instrument panel), stop the engine, wait for at least 5 seconds and repeat the starting procedure described above.

STARTING WITH FLAT KEY BATTERY

If the remote control battery is flat, proceed as follows to start the car:

□ lift the front armrest;



ABC

□ lay the key on the indicated spot, positioning as shown in fig. 9.



STEERING COLUMN LOCK

(where provided)

Activation

The steering lock is engaged when the driver door is opened with the ignition device button at STOP.

Deactivation

The steering column lock disengages when the ignition device is pressed and the electronic key is recognised.



WARNING

2) Always take the key with you when you leave your car to prevent someone from accidentally operating the controls. Remember to engage the electric parking brake. Never leave children unattended in the car.

3) It is absolutely forbidden to carry out any after-market operation involving steering system or steering column modifications (e.g. installation of anti-theft device) that could adversely affect performance, invalidate the warranty, cause **SERIOUS SAFETY PROBLEMS** and also result in the car not meeting type-approval requirements.

4) Before leaving the vehicle, **ALWAYS** engage the handbrake. Activate mode P (Park) and press the ignition device to set it to STOP. When leaving the vehicle, always lock all the doors by pressing the button on the handle.

5) For versions equipped with the Keyless Start system, do not leave the electronic key inside or near the car or in a place accessible to children. Do not leave the car with the ignition device in ON position. A child could activate the electric window winders, other controls or even start the car.

6) If the ignition device has been tampered with (e.g. an attempted theft), have it checked over by the Alfa Romeo Dealership before driving again.

ENGINE IMMOBILIZER

The Engine Immobilizer system prevents unauthorised use of the car preventing to start the engine.

The system does not need to be enabled/activated: operation is automatic, regardless of the fact that the car's doors are locked or unlocked.

IRREGULAR OPERATION

If, during starting, the key code is not correctly recognised, the  symbol appears the instrument panel (see the instructions in the "Warning lights and messages" chapter in the "Knowing the instrument panel" section). This condition leads to the engine stopping after 2 seconds. In this case, bring the ignition device to STOP and then to ON; if it is still blocked, try with the other keys provided. If it is still not possible to start the engine, contact an Alfa Romeo Dealership.

If the  symbol is displayed while driving, this means that the system is running a self-diagnosis (e.g. due to a voltage drop). If the display persists, contact an Alfa Romeo Dealership.

WARNINGS

Do not tamper with the Engine Immobilizer system. Any modifications/alterations could

cause the protection function to be deactivated.

The Engine Immobilizer system is not compatible with certain aftermarket remote starting systems.

ALARM

(where provided)

ALARM ACTIVATION

The alarm goes off in the following cases:

- wrongful opening of doors/bonnet/boot (perimeter protection);
- operation of ignition device with a key which is not validated;
- cutting of the battery leads;
- movement inside the passenger compartment (volumetric protection, where provided);
- anomalous lifting/tilting of the car (anti-lift protection, where provided).

Activation of the alarm triggers the horn and the direction indicators.

WARNING The function is ensured by the Engine Immobilizer system, which is automatically activated when you get out of the car taking the electronic key with you and locking the doors.

WARNING The alarm is adapted to meet requirements in various countries.

TURNING THE ALARM ON

With the doors, bonnet and boot closed and the ignition device turned to STOP, point the electronic key towards the car and press and release button . The alarm can also be engaged by pressing the "door lock" button, located on the door external handle. For further information, see "Passive Entry" in the "Doors" chapter.

Except on some versions for specific markets, the system produces a visual and acoustic warning and enables door locking.

With the alarm on, the warning lights on the door handle trims remain on continuously fig. 10.

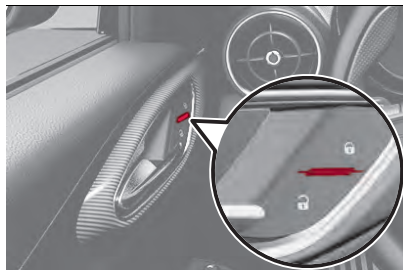



10

9550202

In case of faults the system will generate a further acoustic signal.

If a second acoustic signal is emitted after the alarm is switched on, wait about 4 seconds and switch off the alarm by

pressing the  button. Check that the doors, bonnet and tailgate are closed properly and then reactivate the system by pressing the  button.

If the alarm emits an acoustic signal even when the doors, tailgate and luggage compartment are closed properly, a system fault has occurred: in this case, contact an Alfa Romeo Dealership

TURNING THE ALARM OFF

Press the  button. The following actions are performed:

- two brief flashes (where provided) of the direction indicators;
- two brief acoustic signals (where provided);
- doors are unlocked.

The alarm can also be disengaged by the holder of the key, by grasping one of the front handles. For further information see the "Passive Entry" item in the "Doors" paragraph.

WARNING The alarm does not switch off when the central opening is activated using the metal insert in the key.

VOLUMETRIC/ANTI-LIFTING PROTECTION

(where provided)

To ensure the correct operation of the protection, completely close the side windows.



ABC

To exclude the function, press button fig. 11 before activating the alarm.

When the function is turned off, this is indicated by the LED on the button flashing for several seconds.

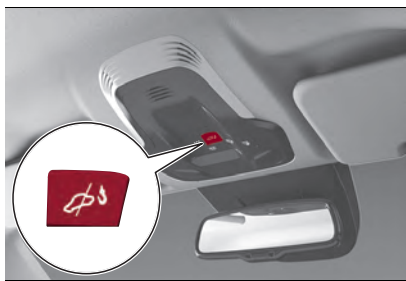

11

0404650002EM

DISARMING THE ALARM

To completely disable the alarm (e.g. during a long period of car inactivity), lock the doors by turning the metal insert, found inside the electronic key, in the door lock.

DOORS

LOCKING/UNLOCKING DOORS FROM THE INSIDE

Central locking/unlocking

If all doors are closed properly, they will automatically be locked once the car has exceeded about 20 km/h ("Auto relock" function active).

Press the button on the driver side , passenger side fig. 12 or rear (where provided) door panel trims to lock the doors.

With the doors locked, press the  button on the front door panel trims to unlock them.

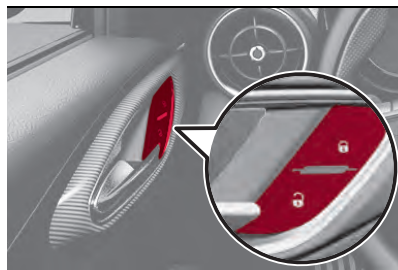

12

9550183

LOCKING/UNLOCKING DOORS FROM THE OUTSIDE

Locking from the outside

With the doors closed, press the  button on the key.

In any case, the doors can be locked with all the doors closed and the tailgate

open. When the button  on the key is pressed, all the locks are closed, including that of the open tailgate. The latter will be locked when it is closed.



Door unlocking from the outside

Press the button  on the key.

Locking/unlocking doors from the outside in an emergency

If the battery is flat or the remote control is faulty, you can lock/unlock the doors from the outside by inserting and rotating the metal insert (available inside the electronic key) in the lock of the driver side door.

PASSIVE ENTRY

(where provided)



The Passive Entry system can identify the presence of an electronic key near the doors and the tailgate.

The system enables the doors (or the tailgate) to be locked/unlocked without pressing any buttons on the electronic key.

The key is detected only after the system recognises the presence of a hand in one of the front handles. If the detected key is valid, the doors and the tailgate are unlocked (the elements that open depend on the Connect system settings).

Where the function is provided, grasping the handle of the driver's door unlocks the driver's door only, or all the doors, depending on the mode set in the Connect system.

WARNING If wearing gloves, or if it has rained and the door handle is wet, the activation sensitivity of the Passive Entry function may be reduced, resulting in a longer reaction time.

Door locking

To lock the doors, proceed as follows:

- ❑ make sure that you have the electronic key and are close to the driver or passenger side door handle;
- ❑ press the "door locking" button fig. 13 on the handle: this will lock all the doors and the tailgate. Locking the doors will also activate the alarm (where provided).

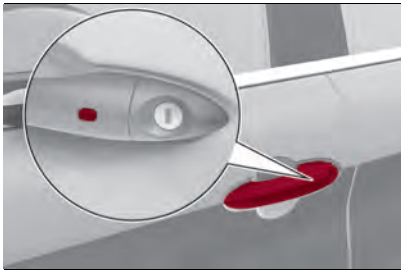

13

04056S0003EM

WARNING After pressing the "door locking" button, you need to wait two seconds before the doors can be

unlocked again using the door handle. It is therefore possible to check whether the car is locked correctly by pulling the door handle within 2 seconds. The doors will not be unlocked again.

The doors and tailgate can anyway be locked pressing button  on the electronic key or on the inner door panel.

Driver side door emergency opening

If the electronic key does not work, e.g. because its battery is flat or the car battery is flat, the emergency metal insert inside the key can anyway be used to operate the lock, unlocking the driver side door.

To extract the metal insert, proceed as follows:

- ❑ Press in the points shown fig. 14 and slide the cover off downwards;
- ❑ remove the key insert from its housing fig. 15;
- ❑ insert the metal insert in the driver side door lock and turn it to unlock the door.



14

04016S0002EM

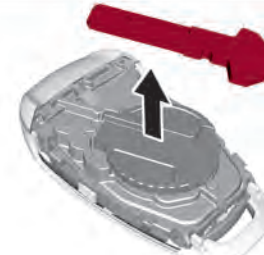

15

04016S0003EM

NOTE The metal insert of the key has no forced insertion direction and can be inserted indifferently in the lock.

WARNINGS

To avoid leaving the electronic key inside the car accidentally, the Passive Entry function features an automatic door unlocking function.

If one of the car doors is open and the "door lock" button is pressed located on the front door handles, or the button



ABC

🔒 in the door panel inner trim, once all the doors are closed, the car checks the inside and outside of the car to check for the presence of enabled electronic keys. When pulling the handle, do not press the door lock/unlock button on the handle fig. 16.

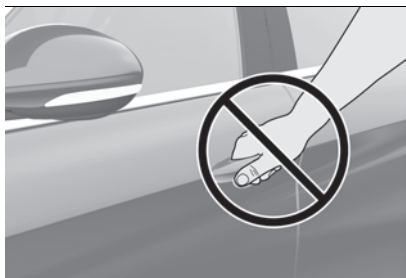

16

04056S0004EM

If one of the electronic keys is detected inside the car and no other active electronic key is detected outside the car, the Passive Entry function automatically unlocks all the car doors, sounds three times and operates the direction indicators.

If, on the contrary, one or more electronic keys are inside the passenger compartment, pressing the button 🔒 on the remote control the keys inside the passenger compartment are temporarily disabled.

The car will **not unlock** the doors if one of the following situations is present:

❑ an unauthorised electronic key close to the car has been detected outside. If the Passive Entry function is disabled using the Connect system, the protections to avoid leaving accidentally the electronic key inside the car are deactivated.

Boot access

Approach the tailgate with a valid electronic key and press the opening button fig. 17 to access the boot.



17

04056V0005EM

WARNING If the electronic key is inadvertently forgotten inside the boot and an attempt is made to close it from the outside, the tailgate will not lock unless another electronic key is recognised outside and close to the car. With the doors locked, if only the tailgate is unlocked and a key is detected inside when it is locked again, the tailgate will be unlocked again and the lights will flash twice.

WARNING Before driving make sure the tailgate is closed correctly.

Tailgate locking

The tailgate may still be locked by pressing the 🔒 button on the electronic key, by pressing the door lock button on the external handles or by pressing the 🔒 button on the door panel.

System activation/deactivation

The Passive entry system can be activated/deactivated using the Connect system.

POWER LOCK DEVICE

(where provided)



This safety device inhibits the operation of the interior door handles and the door locking/unlocking button.

It thereby prevents the opening of the doors from inside the passenger compartment, serving as an obstacle to break-in attempts (e.g. broken window). We recommend that you activate the device each time you park your car.

Activating the device

The device is enabled on all the doors by pressing the 🔒 button on the key twice quickly.

The direction indicators flash 3 times to let you know that the device is active.

If one or more of the doors are not closed correctly, the device will not activate, thus preventing a person from getting stuck inside the passenger compartment by entering the car through, and then closing, the open door.

Deactivating the device

The device disengages automatically:



- when the doors are unlocked (pressing button  on the key with remote control);
- when the ignition device is set to ON.

CHILD LOCK



This system prevents the rear doors from being opened from the inside.

This device (1) fig. 18 can be engaged only with the doors open:

- position : device engaged (door locked);
- position : device not engaged (door may be opened from the inside).

The device remains engaged even if the doors are electrically unlocked.

WARNING The rear doors cannot be opened from the inside when the child lock is engaged.

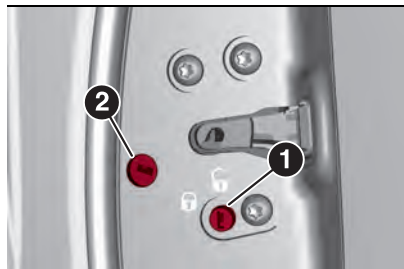

18

0405650037EM

UNLOCKING THE DOORS WITH A FLAT BATTERY



Proceed as follows to unlock the doors if the car battery is flat.

Rear doors and passenger door

Proceed as follows:

- insert the metal insert of the electronic key in the release device housing (2) fig. 18;
- turn the key clockwise for the right door locks or anticlockwise for the left door locks;
- remove the key from the housing.

Proceed in one of the following ways to realign the door lock device (only when the battery charge has been restored):

- press the  button on the electronic key;
- press the  button on the door panel;
- open by inserting the key insert in the driver's door lock;

- operate the internal door handle.

WARNING For the rear doors, if the child lock device was engaged and the previously described locking procedure carried out, operating the internal handle will not open the door but will only realign the lock release device. To open the door, the outside handle must be used. The door central locking/unlocking buttons are not deactivated when the emergency lock is engaged.



WARNING

7) Once the Power Lock system is engaged, it is impossible to open the doors from inside the car. Before getting out of the car, please therefore check that there is no-one left inside.

8) NEVER leave children unattended inside the car, let alone leave the car with the doors unlocked in a place that children can access easily. Children may seriously, or even fatally, injure themselves. Also ensure that children do not inadvertently operate the electric parking brake, the brake pedal or the automatic transmission lever.

9) Always use this device when carrying children. After engaging the device on both rear doors, check that it is actually engaged by trying to open a door with the internal handle.



ABC

**IMPORTANT**

2) Make sure to take the key with you once a door or the boot is locked, to prevent forgetting the key inside the car. If the key is locked inside, it can only be retrieved by using the second key provided.

3) The operation of the recognition system depends on various factors, such as, for example, any electromagnetic wave interference from external sources (e.g. mobile phones), the charge of the battery in the electronic key and the presence of metal objects near the key or the car. In these cases it is still possible to unlock the doors by using the metal insert in the electronic key (see description on the following pages).

SEATS

WARNING Carry out the adjustment while sitting on the seat involved (driver side or passenger side).

Driver seat adjustment must also be carried out remembering that, keeping the shoulders resting firmly against the backrest, the wrists must be able to reach the top of the steering wheel rim. It must also be possible to fully press the brake pedal with the right foot.

FRONT SEATS WITH MANUAL ADJUSTMENT**Longitudinal adjustment**

Lift lever (1) fig. 19 and push the seat forwards or backwards.

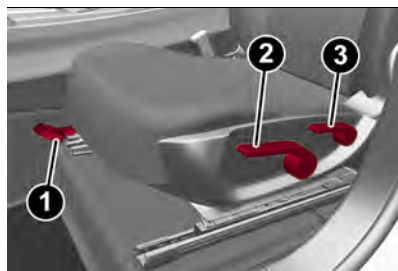

19

04066V0001EM

Height adjustment

Pull lever B (2) fig. 19 upward or push downward to reach the desired height.

Backrest angle adjustment

Use lever (3) fig. 19 to adjust the backrest angle, accompanying it with the movement of the torso (operate the lever until the desired position is reached, then release it).

Folding the backrest forward
(where provided)

The front passenger seat can be folded forward by operating lever (3) fig. 19.

During this operation, accompany the backrest down with your free hand.

Folding the backrest down further increases the size of the load compartment.

“SPARCO” CARBONSHELL SPORT SEATS

(where provided)

Longitudinal adjustment

Lift lever (1) fig. 20 and push the seat forwards or backwards.

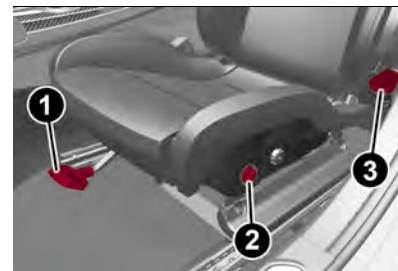

20

04066S0002EM

Height adjustment
(electric)

Press the button (2) fig. 20 up or down until the required height is reached.

Backrest angle adjustment

Use lever (3) fig. 20 to adjust the backrest angle, accompanying it with the movement of the torso (operate the lever until the desired position is reached, then release it).

ELECTRICALLY ADJUSTABLE FRONT SEATS



These buttons for electrically to adjust the seat height, the lengthwise position in relation to the car and the angle of the backrest.

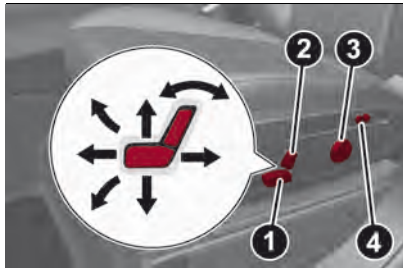

21

04066V0003EM

Height and/or cushion tilt adjustment

Act on the rear part of the switch (1) fig. 21.

Longitudinal adjustment

Push switch (1) fig. 21 forwards or backwards to move the seat in the corresponding direction.

Backrest angle adjustment

Push switch (2) fig. 21 forwards or backwards to adjust the backrest in the corresponding direction.

Power lumbar adjustment

Use the joystick (3) fig. 21 to operate the lumbar support device.

WARNING The electrical adjustment is only allowed when the ignition device is turned to ON and for about 2 minutes after it is turned to STOP. The seat can also be moved after opening/closing the door for about 2 minutes; car locking/unlocking or switching on of the centre front ceiling light.

Seat angle adjustment (tilting)

(where provided)

The seat angle can be set to four positions. Lift or lower the front of control (1) fig. 21 to move the front of the seat in the corresponding direction. Release control (1) when the seat has reached the desired position.

Backrest width adjustment

(where provided)

Push the switches (4) fig. 21 to adjust the width of the backrest by means of the lateral padding.

Seat cushion extension

(where provided)

Lift the lever (6) fig. 22 and push the front of the cushion forward or back. It can move a few centimetres.

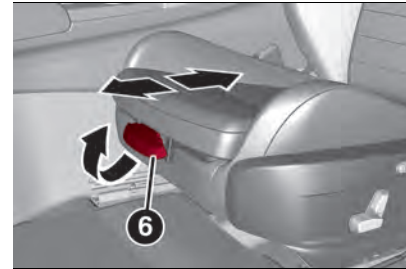

22

04066S0017EM

Storing the driver's seat positions

The buttons (5) fig. 23 allow you to store and recall three different driver's seat positions.

You can store and recall for 20 minutes with the ignition device in the STOP position or with the ignition device in the ON position, the engine running and the car moving. The performed position memorisation is confirmed by a beep. To memorise a seat position, adjust it with the various controls, then press the button where you want to memorise the position for 1.5 seconds.

To memorise the position. When a new seat position is memorised, the previously memorised position on the same button is automatically overwritten.

Recalling a memorised position is also possible for about 3 minutes after the doors are opened and about 1 minute after the engine is stopped. To recall a



ABC

memorised position, press the relevant button briefly.

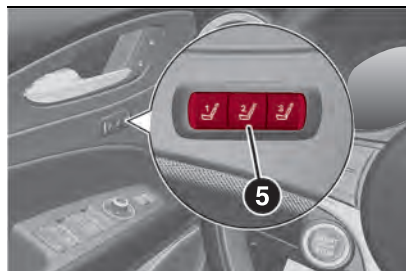

23

04066V0015EM

EASY ENTRY FUNCTION

The Easy Entry function is designed to retract the driver side seat automatically by 2.36 in (60 mm) to make it easier for the driver to get in and out of the car.

The movement is activated only if the seat is set to a driving position which is in "front" of the central pillar of the car.

The function is associated with electrically adjustable front seats for each of the three stored positions.

The Easy Entry function can be activated/deactivated using the Connect system.

Activating entrance mode

With the door open and the ignition switch at STOP, the driver side seat will be in a position retracted by 2.36 in (60 mm) with respect to the driving position set by the user.

When the door is closed and the ignition device is in the ON position, the seat will automatically return to the set driving position.

If the seat is moved manually while it is still in retracted position, it will remain in the new set position when the car is entered again.

NOTE If the seat is moved manually while it is still in retracted position, it will remain in the new set position when the car is entered again.

Activating entrance mode

With the door open and the ignition switch at STOP, the driver side seat will be in a position retracted by 2.36 in (60 mm) with respect to the driving position set by the user.

When the door is closed and the ignition device is in the ON position, the seat will automatically return to the set driving position.

WARNING If the seat is moved manually while it is still in retracted position, it will remain in the new set position when the car is entered again.

Activating exit mode

In order to help the driver get out of the car, the driver side seat will move back by 2.36 in (60 mm) when the ignition device is in STOP mode and the driver side door is opened.

NOTE Pressing any button on the seat memory or control panel will immediately interrupt the automatic positioning function (antipanic function). The operation must be repeated to complete the function.

FRONT SEAT ELECTRIC HEATING

(where provided)

With ignition device at ON, press the buttons  fig. 24 on the dashboard.



24

04066V0110EM

You can select three heating levels:

- "maximum heating": three LEDs lit on the buttons;
- "medium heating": two LEDs lit on the buttons;
- "minimum heating": one LED lit on the buttons.

After selecting one heating level, you need to wait for a few minutes until warm air flows into the compartment.

When the "maximum heating" setting is selected, the heater produces a boosted heat level for the first minutes of operation. After this, the heat lowers to reach the normal temperature level for the selected function.

The seat heating function can also be activated using the Connect system: see the description on the dedicated supplement.

WARNING The electric heating function cannot be activated when the engine off. It only works with the engine running.

WARNING The set heating level is stored when the engine is stopped and is restored if the engine is restarted within a few minutes, otherwise the system will remain off.

REAR SEATS



The rear seats can accommodate two passengers (QV version) or three passengers (other versions).

The seats and the seat belts are considered as components of the protection system for the car's occupants.

WARNING Refer to the "Passenger protection systems" chapter in the "Safety" section for the positioning of the seat belts.

SPLIT FOLDING REAR SEAT Partial extension of the boot (1/3 or 2/3)

Extending the right side of the boot (1/3 of the rear seat) allows you to carry two passengers on the left part of the rear seat, while extending the left side (2/3 of the rear seat) allows you to carry one passenger.

Proceed as follows:

- ❑ completely lower the rear seat head restraints;
- ❑ place the seat belt so that it doesn't impede the movement of the backrest while tilting it;
- ❑ operate the left-hand lever (1), fig. 25 (inside the boot) to fold down the left side, or the mirror image right-hand lever to fold down the right side of the backrest. It will fold forwards automatically. If necessary, accompany the backrest during the initial stage of tilting.

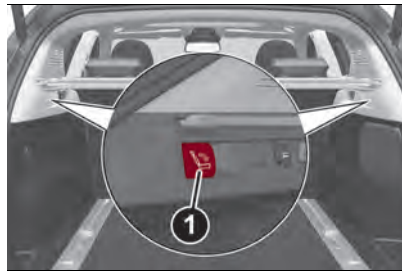

25

04066V0009EM

Full expansion of the boot

Tilting the rear seat completely forwards allows maximum loading volume.

Proceed as follows:

- ❑ completely lower the rear seat head restraints;
- ❑ place the seat belts so that they don't impede the movement of the backrest while tilting it;
- ❑ operate the levers (1) fig. 25 to fold down the backrests. They will fold forwards automatically. If necessary, accompany the backrests during the initial stage of tilting.

It is also possible to disengage sections of the rear seat from inside the passenger compartment using one of the two levers located under the rear seat fig. 26. Each lever folds down the section of the backrest on the same side.



26

04066V0007EM

Repositioning seat backrests



Move the seat belts to the side, making



ABC

sure that they are correctly extended and not twisted and that they are not trapped behind the backrests of the seats, then lift the backrests pushing them back until you hear the locking click on both attachment mechanisms.

Central backrest section tilting

Before tilting the backrest, make sure that the rear central seat belt is not fastened and that there are no objects in the central part of the cushion (if there are any, remove them).

Using the fig. 27 strap, release the central part of the backrest from its housing and tilt it using the head restraint.

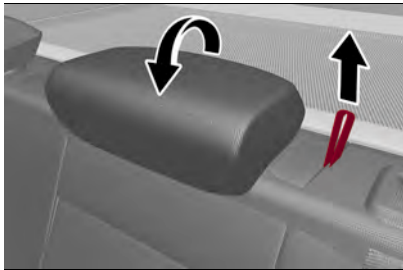

27

04066V0008EM

Central backrest section repositioning

Using the head restraint, lift the central portion upwards, accompanying it during its movement, lightly press to make sure that it is properly attached. Make sure that the armrest is properly attached

by trying to move it. If it is not attached correctly, repeat the operation.



WARNING

- 10) All adjustments must be carried out only with the car stationary and engine off.
- 11) After releasing the adjustment lever, always check that the seat is locked on the guides by trying to move it back and forth. If the seat is not locked into place, it may unexpectedly slide and cause the driver to lose control of the car.
- 12) Always make sure that all those on board the car are seated and are wearing their seat belts correctly.
- 13) Make sure the backrests are properly secured at both sides to prevent them from moving forward, in the event of sharp braking, with possible impact with of the passengers.



IMPORTANT

- 4) The fabric upholstery of the seats has been designed to withstand long-term wear deriving from normal use of the car. Some precautions are however required. Avoid prolonged and/or excessive rubbing against clothing accessories such as metal buckles and Velcro strips which, by applying a high pressure on the fabric in a small area, could cause it to break, thereby damaging the upholstery.
- 5) Do not place any kind of items under the electrically adjusted seats as they

could impede their movement or otherwise damage the controls.

HEAD RESTRAINTS

ADJUSTMENTS



14)

Upward adjustment: raise the head restraint until it clicks into place.

Downward adjustment: press button (1) fig. 28 and lower the head restraint.



28

04076V0001EM

REAR HEAD RESTRAINTS (adjustments)

Upward adjustment: raise the head restraint until it clicks into place.

Downward adjustment: press button (1) fig. 29 and lower the head restraint.

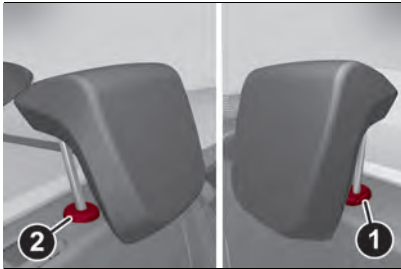

29

04076V0002EM

HEAD RESTRAINTS (removal)

Proceed as follows to remove the head restraints:

- raise the head restraints to their maximum height;
 - press the button (1), lift the head restraint, then, pressing the device (2) fig. 28 (front head restraints) or (1) and (2) fig. 29 (rear head restraints), remove it.
- WARNING** Always re-position the rear head restraints if they had been removed before starting to drive normally. Re-fit the rods of the head restraints in their housings, holding buttons (1) and (2) pressed. Then, re-position the head restraints according to your needs.



WARNING

14) Head restraints must be adjusted so that the head, rather than the neck, rests on them. Only in this case they can protect your head correctly. Any removed head restraints must be repositioned correctly, in order to protect the occupants in the event of a collision: follow the instructions above.

STEERING WHEEL



15) 16) 17) 18) 19)

ADJUSTMENTS

The steering wheel can be adjusted both in height and in depth.

To carry out the adjustment move the lever (1) fig. 30 downwards in position (A), then adjust the steering wheel to the most suitable position and then lock it in this position moving the lever (1) again in position (B).

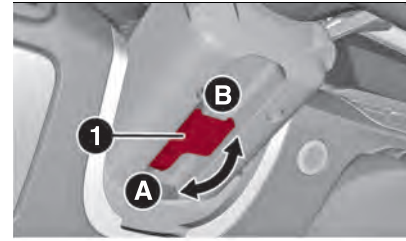

30

9490237

ELECTRIC STEERING WHEEL HEATING (where provided)

With ignition device at ON, press the button  fig. 31 on the climate control system dashboard.



ABC

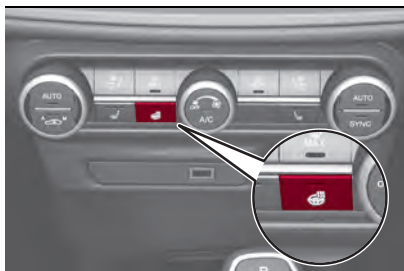

31

04066V011EM

When the function is on, the LED on the button switches on.

WARNING If this function is activated with the engine stopped the battery may run down.



WARNING

15) All adjustments must be carried out only with the car stationary and engine stopped.

16) It is absolutely forbidden to carry out any after-market operation involving steering system or steering column modifications (e.g. installation of anti-theft device) that could adversely affect performance, invalidate the warranty, cause **SERIOUS SAFETY PROBLEMS** and also result in the car not meeting type-approval requirements.

17) People who are insensitive to skin pain due to old age, chronic disease, diabetes, spine cord injury, medical treatment, alcohol use, exhaustion or other physical conditions, must be careful when using the steering

wheel heater as it could cause burns even at low temperature, especially if used for long periods.

18) Do not place objects on the steering wheel that may create heat insulation, such as coverings permanently fixed to the steering wheel of any type or material. It may cause the steering wheel heating device to overheat.

19) Do not place any objects on the steering wheel (e.g. permanently fixed covers of any type or material) which could interfere with the capacitive hand detection sensor on the steering wheel of the ABSA (Active Blind Spot Assist), LKA (Lane Keeping Assist), TJA (Traffic Jam Assist) or HAS (Highway Assist) systems (where applicable).

REAR-VIEW MIRRORS

ELECTROCHROMIC REAR-VIEW MIRROR

The electrochromic rear-view mirror has an ON/OFF button fig. 32 to activate/deactivate the electrochromic anti-glare function.



32

04106S0002EM

DOOR MIRRORS



20)

Electric adjustment

The mirrors can only be adjusted with the ignition device at ON.

Select the desired mirror using device (1) fig. 33:

device in position (A): left mirror selected;

device in position (B): right mirror selected.

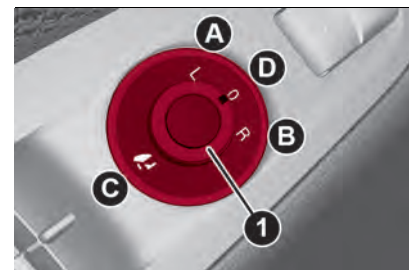

33

04106V0004EM

To adjust the selected mirror, use device (1) in the four directions.

WARNING Once adjustment is complete, rotate device (1) to position (D) to prevent accidental movements.

Manual folding

To fold the mirrors move them from the open position to the closed position fig. 34.

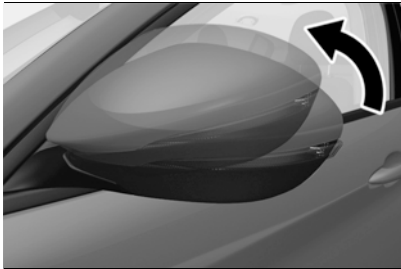

34

04106V0005EM

Electric folding

(where provided)

With the device (1) in position (D) move it to position (C) fig. 33. Turn the device (1) again to position (C) to return the mirrors to the driving position.

NOTE In case of involuntary movement of the mirrors (following a crash) beyond the normal operating position, the system will activated an auxiliary realignment cycle when the first opening/closing command is imparted. The mirror will therefore return to the overtravel position which was reached by accident, will fold and then open to the correct position.

If the device (1) is pressed again during door mirror folding (from closed to open position and vice versa), their movement direction is reversed.

Automatic activation

Activating the central door locking

system from outside the car automatically folds the mirrors: they return to the driving position when the ignition switch is turned to the ON position.

If the exterior mirrors were folded using device (1), they can only be returned to the driving position using the same device.

Activation/deactivation of the function

The electric mirror folding function can be activated/deactivated using the Connect system menu (the default setting of the function "Off"). Alternatively, you can choose to open/close the mirrors automatically when opening/closing the doors (using the electronic key or the Passive Entry system).

WARNING The hand-controlled electric folding operation can be enabled only when the car speed is lower than 30 mph (50 km/h), so they can only be manually controlled up to that speed.

WARNING The mirrors must always be open while driving and should never be folded.

ELECTROCHROMIC EXTERIOR MIRRORS

(where provided)

These mirrors can automatically modify

its reflecting action to prevent dazzling the driver. The electrochromic rear-view mirror function on/off button fig. 32 is the same for all rear-view mirrors.

ELECTRIC DOOR MIRROR HEATING

Pressing the  button on the climate control system activates the demisting/defrosting of the door mirrors.



WARNING

20) As door mirrors are curved, and therefore they may slightly alter the perception of distance.



ABC

EXTERNAL LIGHTS

LIGHT SWITCH

The following controls are available in the panel on the left of the steering wheel: fig. 35

- (1)- side lights, daylight running lights, dipped beam headlight switch;
- (2) : ring nut for adjusting the brightness of the instrument panel and the graphics on the control buttons;
- (3): rear fog lights button.

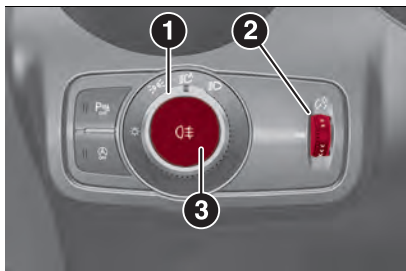

35

9490200

The external lights can be switched on only when the ignition device is in position ON, except for the parking lights. See the "Parking lights" paragraph, in this chapter for more information.

The instrument panel and the various controls on the dashboard will be lit up when the exterior lights are switched on.

AUTO FUNCTION (Dusk sensor)

This is implemented by an infrared LED sensor on the windscreen that works in conjunction with the rain sensor. It is able to detect variations in the outside light level based on the light sensitivity set through the Connect system.

The dusk sensor sensitivity can be adjusted according to 3 levels: level 1=minimum sensitivity, level 2=average sensitivity, level 3=maximum sensitivity.

The higher the sensitivity set, the lesser is the external light variation needed to switch the lights on (e.g. with a setting on level 3 at sunset the headlights come on earlier than levels 1 and 2).

Function activation

Turn the light switch to the ☞ position.
WARNING The function can only be activated with the ignition device at ON.

Function deactivation

Turn the light switch to a position other than ☞ .

DIPPED BEAM HEADLIGHTS

Turn the light switch to ☞ to switch on the side lights, the lights on the instrument panel and the dipped beam headlights.

The ☞ warning light switches on in the instrument panel.

DAYTIME RUNNING LIGHTS (DRL) AND SIDE LIGHTS (Daytime Running Lights)

(where provided)



With the ignition device turned to ON and the light switch turned to position ☞ the daytime running lights are automatically activated; the other lights and interior lighting remain off.

Where provided, if the direction indicators are operated, the brightness of the corresponding DRL will be decreased as long as the direction indicators are on.

Where provided, the DRL can be activated/deactivated from Connect system, by selecting the following functions in sequence on the main MENU: "Settings", "Lights" and "Daytime Lights".

WARNING For markets where DRL use is not required, these lights work as side lights and they are switched on and off jointly with the main beam headlights.

REAR FOG LIGHT

The fog light button is integrated with the light switch.



Press the ☞ button to switch the light on/off.

The rear fog light switches on only when the dipped headlights are on. The light can be switched off by pressing the ☞

button again or by switching off the dipped beam headlights.

When the engine is stopped with the rear fog lights on, it will be switched off the next time the engine is started.

PARKING LIGHTS

They are switched on if, within a few seconds from stopping the engine, the light switch is taken first to the  position and then to position . All side lights switch on, if you want to leave only those on one side (right/left) switched on, you need to move the direction indicators control on the position on the side you wish to leave on.

When a front door is opened with the light switch in position , a tone will be heard to inform the driver that the parking lights are on.

The  warning light switches on in the instrument panel.

WARNING Turning the ignition switch to ON turns off the parking lights, which were on only on one side.

HEADLIGHTS OFF TIMER

The "Follow Me" function delays the switching off of the headlights after the engine has been stopped.

The function can be enabled from the Connect system by selecting the following functions from the main menu in sequence: "Settings", "Lights"

and "Follow me"; the side lights and the dipped beam headlights stay on for a time that can be set between 30, 60 and 90 seconds.

Function activation

With the headlights on, take the ignition device to the STOP position: the timer starts when the light switch is turned to the  position.

WARNING To activate this function the headlights must be deactivated within 2 minutes after the ignition device has been taken to STOP.

Function deactivation

This function is deactivated by switching on the headlights, the side lights or bringing the ignition device to ON.

ANIMATIONS

(where provided)

Depending on the version, with the ignition device in the STOP position, an animated sequence of front and rear lights may be shown when the doors are unlocked.

Then they light up fixed. The function is activated from the display menu on the instrument panel or using the Alfa Connect system.

Only the direction indicators will light up when only the tailgate is unlocked.

Activating the alarm or hazard warning lights will disable the function.

AFS (Adaptive Frontlight System) function

(where provided)

This is a system which directs the main light beam, horizontally and vertically, and continuously and automatically adapts it to the driving conditions round bends/when cornering.



The system directs the light beam to light up the road in the best way, taking into account the speed of the car, the bend/corner angle and the speed of steering.

The function is enabled using the display menu of the Connect system.

The function is enabled when the low beam headlights are on.

In the case of LED matrix headlights to comply with type-approval requirements and to avoid dazzling oncoming drivers, the AFS functionality must be disabled if the driver's seat is on the left-hand side of the vehicle and driving in countries with the right-hand lane (and vice versa).

MAIN BEAM HEADLIGHTS

To switch on the fixed main beam headlights, push the left stalk forwards towards the instrument panel fig. 36. The light switch must be turned to  or .

The symbol appears on the instrument panel display when the main beam headlights are on .



ABC

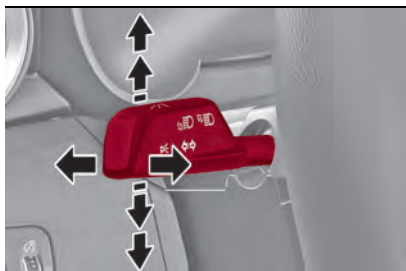

36

9550234

The main beam headlights are switched off by pushing the left stalk forward again. The symbol  might disappear on the instrument panel display.

Blinking

The flashing of the main beam headlights is activated by pulling the left stalk towards the steering wheel, the lights remain on while you are operating the lever.

Automatic high beam (AHB system) headlights

(where provided)

The AHB system is used to switch the high beam headlights on and off automatically and to adapt the lighting near towns.

Function enabling

This function is enabled using the "Driver Assistance" Menu and then selecting

"Comfort" in the Connect system with the light switch turned to position .

Function activation

The first time the main beam headlights are activated (pushing the left lever is displayed the function is activated (the  symbol appears in the instrument panel)).

The symbol  appears on the instrument panel display when the main beam headlights are on.

The function activates the high beam headlights when the speed is higher than 25 mph (40 km/h).

When the speed is lower than 15 mph (25 km/h) and the function is active, the function switches the main beam headlights off.

If the fixed main beam headlights are operated quickly again (pushing the left stalk towards the instrument panel), the warning light/icon  will switch on in the instrument panel and the main beam headlights will be switched on fixed until the speed exceeds 25 mph (40 km/h).

When the speed of 25 mph (40 km/h) is exceeded again, the automatic functioning is reactivated.

If the left stalk is pushed again in this condition, to request main beam headlight deactivation, the function deactivates and the main beam headlights switch off.

Function deactivation

To deactivate the automatic function rotate the light switch ring to position . WARNINGS

The correct operation of the automatic high beam function may be influenced by:

- presence of reflections on road sign surfaces;
- dim light of other road users (e.g. cyclists or pedestrians);
- bad weather (rain or fog);
- presence of dirt on the sensor or obstruction of the sensor;
- damage to the windscreen or presence of dirt or ice/snow or misting up of the windscreen;
- presence of vehicles approaching in the opposite direction partially obscured by a central obstacle.

WARNING Make sure that the windscreen is always defrosted and demisted in winter.

GLARE-FREE

The "Glare-Free" function assists the driver when driving on out-of-town roads with poor lighting conditions by allowing the use of main beam lights even in the presence of other cars without the risk of dazzling them.

The glare-free effect is achieved by arrays of LEDs, which are dynamically switched on and off to detect a shaded

area at the headlights of every vehicle on the road (including motorbikes and bicycles), based on information about the headlights of other cars provided by the forward-facing digital camera located on the windscreen below the interior rear-view mirror.

The glare-free system is of the multi-shadow type, as it can create up to four light tunnels at the same time, and each tunnel area is as wide as the obstacle that must not be dazzled.

The figure shows an example of different scenarios:

- ❑ (1) two cars are travelling in front in the same direction;
- ❑ (2) another car is overtaking;
- ❑ (3) another car is travelling in the opposite direction.

The system can detect and react to vehicles ahead or oncoming within seconds.

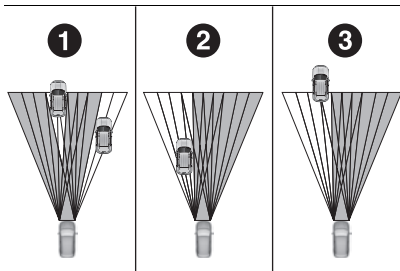

37

9550196

Activation mode

The digital camera is the same as the one used for automatic main beam and, as with automatic main beam, the Glare Free function must be activated on the Connect system by ticking the automatic main beam dimming option.

The glare-free function will be activated after the following actions:

- ❑ starting the engine;
- ❑ turning the light switch to ☞ ;
- ❑ turning on the lights;
- ❑ turning the left stalk to "Main beam headlights" on.

The glare-free function is activated if:

- ❑ the vehicle speed is equal to or greater than 22 mph (35 km/h) during the activation phase of the function;
- ❑ the ambient light is not sufficient for safe and comfortable driving;
- ❑ there is traffic outside the cities.

When the system is active, the white symbol ☞ appears on the display, the blue ☞ symbol replaces the previous one and indicates that all or only some of the LED of the main beam headlights are on at the moment.

In the event that the entire main beam module has to be switched off to achieve a glare-free effect on the instrument panel, only the green indicator will remain lit.

The blue symbol ☞ will be displayed again when the situation allows partial or full use of the high beam headlights without causing glare.

Notes

- ❑ some unpredictable conditions, such as dirt, dust, films or other obstructions on the camera lens, may affect the proper functioning of the glare-free function
- ❑ heavy rain and fog can affect the performance of the system or lead to its deactivation, leaving the high beam headlights on for longer than the nominal operating conditions. This can dazzle other cars and cause disturbance. To avoid this, the high beam headlights must be switched off manually;
- ❑ when the function is deactivated, the minimum operating speed is 9 mph (15 km/h);
- ❑ the correct operation of the Glare-Free function is guaranteed if the car speed is less than or equal to 155 mph (250 km/h).

DIRECTION INDICATORS

The direction indicators could assume two different flashing strategies: continuous or temporary (Lane Change). To activate the continuous flashing function, move the left lever until end of stroke (unstable):



ABC

□ *up*: right direction signal activated, the warning light → flashes on the instrument panel;

□ *down*: left direction signal activated, the warning light ← flashes on the instrument panel.

Warning light → or ← will blink on the instrument panel.

The direction indicators turn off automatically when the car is brought back onto a straight course or by moving the lever in the opposite direction until the first click (about half way).

"Lane Change" function

When you want to signal the change of the driving lane, move the lever until the first impulse (about half stroke).

The direction indicator on the side selected will be activated for 3 flashes and then go out automatically. To turn off the flashing before the end of the cycle, move the stalk in the opposite direction until the first click (about half way).

"CORNERING LIGHTS" FUNCTION

(where provided)

The function activates with the main beam headlights switched on: for wide wheel rotation angles, a light will turn on, built in the headlight referring to the turning side which will extend the nighttime visibility angle.

HEADLIGHT ALIGNMENT ADJUSTMENT

Light beam direction

The correct aiming of the headlights is important for the comfort and safety of not only the driver but all other road users. This is also covered by a specific rule of the highway code.

The headlights must be correctly aligned to guarantee the best visibility conditions for all drivers while travelling with headlights on.

Check the light beam alignment every time the load or its distribution changes.

Contact a Alfa Romeo Dealership to have the headlights checked and adjusted, if necessary.

INSTRUMENT PANEL AND CONTROL BUTTON GRAPHIC BRIGHTNESS ADJUSTMENT

With side lights or headlights on, move the ring (1) fig. 38 upwards to increase light brightness of the instrument panel and of the control button graphics, or ring downwards to decrease it.

The control is pulsed so that for every action the level intensity increases/decreases, up to a maximum of seven.



38

9490197



WARNING

21) The daytime running lights are an alternative to the dipped headlights while driving during the daytime in countries where it is compulsory to have lights on during the day; where it is not compulsory, the use of daytime running lights is permitted.

22) Daytime running lights cannot replace dipped beam headlights while driving at night or through tunnels. The use of daytime running lights is governed by the highway code of the country in which you are driving. Comply with legal requirements.

INTERIOR LIGHTS

FRONT CEILING LIGHT

- ❑ Switch (1) turns light (8) on/off.
- ❑ Switch (2) activates/deactivates the rear ceiling buttons.
- ❑ Switch (3) turns all lights inside the ceiling lights (front and rear) in the passenger compartment on/off.
- ❑ Switch 4 activates or deactivates turning ceiling lights (6), (7) and (8) on/off when the doors are opened/closed. The lights switch on/off gradually.
- ❑ Switch (5) turns light (6) on/off.

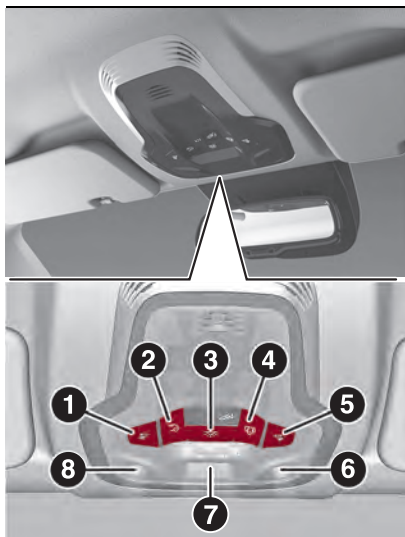

39

0413650071EM

WARNING Before getting out of the car, make sure that the ceiling light is off; if a light is left on, it will automatically switch off approximately 15 minutes after the engine has been stopped.

Timing while getting into the car

The ceiling lights switch on according to the following modes:

- ❑ for a few seconds when the doors are unlocked;
- ❑ for about 3 minutes when one of the doors is opened;
- ❑ for a few seconds when the doors are locked.

Timing is interrupted when the ignition device is turned to ON.

Three modes are provided for switching off:

- ❑ when all doors are closed, the three-minute timer will stop and a few-seconds one will start. This timing will stop when the ignition device is turned to ON;
- ❑ when doors are locked (either with remote control or with key inserted on driver side door), the ceiling light switches off;
- ❑ the interior lights are switched off in any case after 15 minutes to preserve battery charge.

Timing while getting out of the vehicle

After positioning the ignition device

to STOP, the ceiling lights switch on as follows:

- ❑ for a few seconds after the engine stops;
- ❑ for about 3 minutes when one of the doors is opened;
- ❑ for a few seconds when one of the doors is closed.

The timing stops automatically when the doors are locked.

GLOVE COMPARTMENT LIGHT

This light comes on automatically when the glove compartment is opened and switches off when it is closed regardless of the ignition device status.



40

04136V0003EM

INTERIOR AMBIENT LIGHTING

The brightness of the interior passenger compartment lights can be adjusted through the Connect system. The brightness can be adjusted at seven levels.



ABC

DOOR LIGHT

The light fig. 41 comes on automatically when the door is opened and switches off when it is closed regardless of the ignition device status.



41

04136V0007EM

There is also an additional light on the car, located under each exterior front door handle, fig. 42.

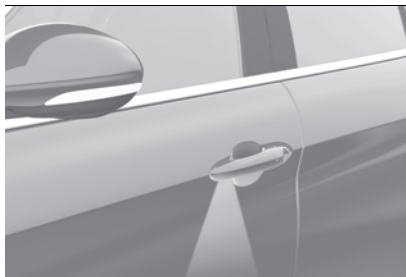

42

04136S0005EM

REAR CEILING LIGHT

The rear ceiling lights buttons are activated or deactivated with button (2) fig. 39 of the front ceiling lights.

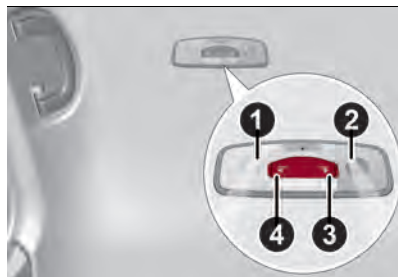

43

04136S0004EM

Switch (3) fig. 43 turns light (2) on/off.

Switch (4) turns light (1) on/off.

The lights switch on when a door opened.

The light switches off automatically after a few minutes if a door is left open. To switch it on again, open another door or close and reopen the same door.

BOOT CEILING LIGHTS

The ceiling lights switch on/off regardless of the position of the ignition switch.

If the boot is left open, the lights will automatically switch off after 15 minutes to preserve the battery life.

WINDSCREEN WIPER

The right stalk controls screen wiper/washer operation.

This operates only with the ignition device at ON.

WINDSCREEN WIPER/ WASHER**Operation**

The ring fig. 44 can be set to the following positions:

- 0 screen wiper off.
- A rotating the ring nut to the first position activates the first sensitivity level of the rain sensor.
- A rotating the ring nut to the second position activates the second sensitivity level of the rain sensor.
- rotating the ring nut to the third position activates the first continuous speed level of the windscreen wipers in manual mode.
- ... rotating the ring nut to the fourth position activates the second continuous speed level of the windscreen wipers in manual mode.



44

9490214

Move the stalk upwards (it only has unstable positions) to activate the MIST function. It only operates while the stalk is held in this position. When released, the stalk will return to its default position and the windscreen wiper will be automatically stopped. This function is useful to remove small deposits of dust from the windscreen, or morning dew.

WARNING This function does not activate the windscreen washer; windscreen washer fluid will not therefore be sprayed onto the windscreen. To spray windscreen washer fluid onto the windscreen, the washing function must be used.

With ring in position **1** or **2**, the windscreen wiper will automatically adapt its operating speed to the speed of the car.

WARNING Windscreen washer operation is disabled when the outside temperature is below 3°C: no jet will

come out of the windscreen washer nozzles and the windscreen wiper blades will not move.

Rain sensor sensitivity level

Positions **1A** and **2A** correspond also to sensitivity level 1 and 2 of the rain sensor.

Smart washing function

Pull the stalk towards the steering wheel (unstable position) to activate a washing cycle.

Hold the stalk pulled to activate both the windscreen washer jet and the windscreen wiper with a single movement, until the stalk is released.

RAIN SENSOR

This is located behind the interior rear view mirror, in contact with the windscreen fig. 45 and can detect the presence of rain and, consequently, manage the cleaning of the windscreen in accordance with the amount of water on the screen.

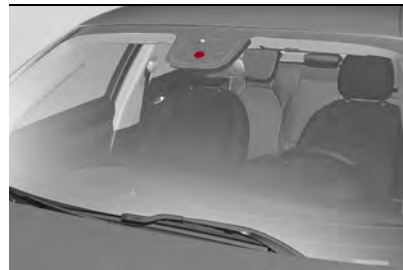

45

04146V0002EM

The sensor has an adjustment range which varies progressively from wiper still (no stroke) when the windscreen is dry, to wiper at 2nd continuous speed (fast continuous operation) with intense rain.

Activation



Turn the ring fig. 44 to position **1A** or **2A** to activate the rain sensor.

Activation of the sensor is signalled by a flick of the wiper, which indicates that the command has been acquired.

The variation in sensitivity during rain sensor operation is also signalled by a flick of the wiper (command acquired and implemented). This stroke is also executed with the windscreen dry.

If the windscreen washer is used with the rain sensor activated, the normal washing cycle is performed, after which the rain sensor resumes its normal automatic operation.

WARNING Keep the glass in the sensor area clean.

WARNING With the windscreen wiper ring turned to the **1A** or **2A** position, wiping operates automatically and is disabled when the external temperature is below 0°C.



ABC

Deactivation

Use ring fig. 44 or turn the ignition device to STOP.

In the event of malfunction of the rain sensor whilst it is active, the windscreen wiper operates intermittently at a speed consistent with the sensitivity setting of the rain sensor, regardless of whether there is rain on the glass, while sensor failure is indicated on the display.

The sensor continues to operate and it is possible to set the windscreen wiper to continuous mode \rightarrow or \rightarrow . The failure indication remains for as long as the sensor is active.

The rain sensor is able to recognise, and automatically adjust itself in the presence of the following conditions:

- presence of dirt on the controlled surface (e.g. salt, dirt, etc.);
- presence of streaks of water caused by the worn windscreen wiper blades;
- difference between day and night.



23)

REAR WINDOW WIPER/WASHER

Engaging reverse gear with the windscreen wiper operating activates a single cycle of the rear window wiper.

Moving the stalk fig. 44 (it only has unstable positions):

- towards the instrument panel activates the rear window washer

(a brief push activates one washing cycle, keeping the stalk pushed washes continuously until the stalk is released);

downwards (with reverse gear engaged) this activates/deactivates the **continuous** operation of the rear window wiper, regardless of the movement of the windscreen wiper;

downwards (with reverse gear **not** engaged) this activates/deactivates **intermittent** operation (with actuating frequency of about 3 seconds) of the rear window wiper, regardless of the movement of the windscreen wiper.



WARNING

23) Make sure the device is turned off whenever the windscreen glass must be cleaned.



IMPORTANT

6) Never use the screen wiper to remove layers of snow or ice from the windscreen glass. In such conditions, the windscreen wiper may be subjected to excessive stress and the motor cut-out switch, which prevents operation for a few seconds, may intervene. If operation is not subsequently restored, even after restarting the engine, contact an Alfa Romeo Dealership.

7) Do not operate the windscreen wiper with the blades lifted from the windscreen.

8) Do not activate the rain sensor when washing the car in an automatic car wash.

9) Make sure the device is switched off if there is ice on the windscreen glass.

CLIMATE CONTROL SYSTEM



GAS IDENTIFICATION LABEL

(where provided)

The label fig. 46 is applied onto the front end of the bonnet.

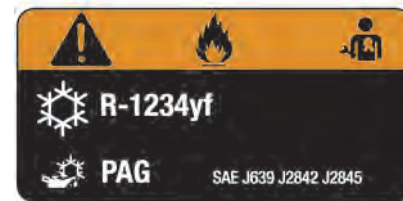

46

0415650007EM

SYSTEM MAINTENANCE

In winter, the climate control system must be turned on at least once a month for about 10 minutes.

Have the system inspected at an Alfa Romeo Dealership before the summer.



IMPORTANT

2) The system uses R1234yf coolant gas, which does not pollute the environment in the event of accidental leakage. Under no circumstances use R134a and R12 fluids, which are incompatible with the components of the system.



ABC

AUTOMATIC DUAL-ZONE CLIMATE CONTROL SYSTEM CONTROLS ON THE CLIMATE CONTROL FRONT PANEL

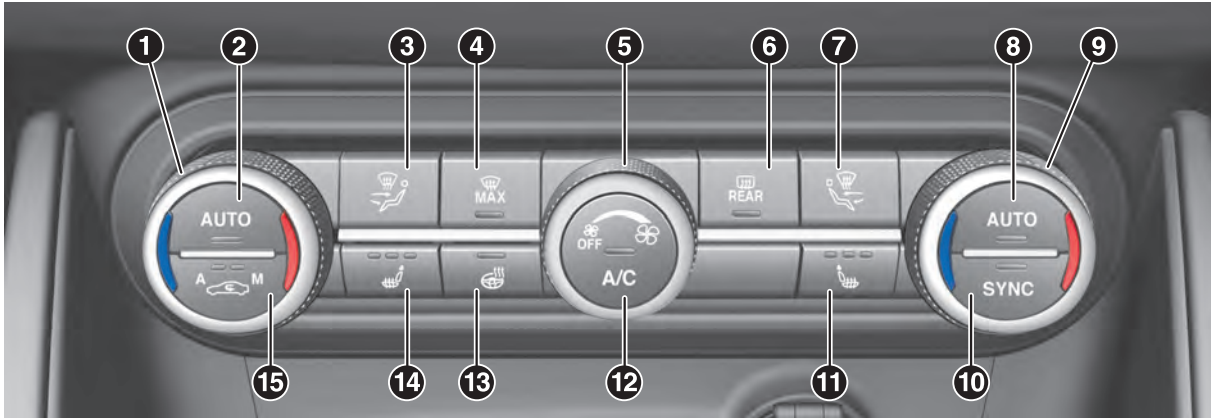

47

041565007EM

1. Driver side temperature adjustment knob 2. Left side AUTO function activation button (automatic operation) 3. Left side air distribution selection button 4. MAX-DEF function activation button (rapid defrosting/demisting); 5. Fan speed adjustment knob 6. Heated rear window on/off button 7. Right side air distribution selection button 8. Right side AUTO function activation button (automatic operation) 9. Right side temperature adjustment knob 10. SYNC function activation button (set temperature alignment) left side/passenger side 11. Right side seat heater activation button; (where provided, see the "Seats" chapter) 12. Climate control compressor on/off button 13. Steering wheel heater activation button; (where provided, see the "Steering wheel" chapter) 14. Left side seat heater activation button; (where provided, see the "Seats" chapter) 15. Internal air recirculation and automatic operation on/off button.

CONTROLS ON CONNECT SYSTEM DISPLAY

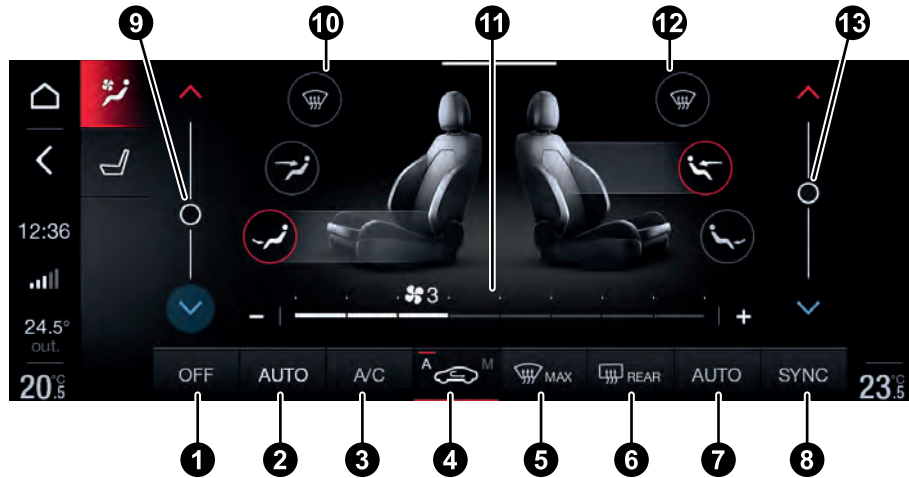

48

12126V0977EM

1. Climate control system on/off graphic button
2. Driver side AUTO function activation graphic button (automatic operation)
3. Graphic button for turning the climate control system compressor on/off
4. Graphic button for turning internal air recirculation on/off (three "states" available: "OFF" or "Manual" or "Automatic")
5. Graphic buttons for activating/deactivating the MAX-DEF function (rapid defrosting/demisting)
6. Heated rear window on/off graphic button
7. Passenger side AUTO function activation graphic button (automatic operation)
8. Graphic button for activating the SYNC function (alignment of set temperatures) on driver/passenger side
9. Graphic bar for temperature adjustment on driver side
10. Graphic buttons for air distribution selection on driver side
11. Graphic bar for adjusting the fan speed
12. Graphic buttons for air distribution selection on passenger side
13. Graphic bar for temperature adjustment on passenger side



ABC

DESCRIPTION

Air flow to the windscreen and front side window vents to demist/defrost them.



Air flow at central and side dashboard vents to ventilate the chest and the face during the hot season.



Air flow to the front and rear footwell vents. This air distribution setting heats the passenger compartment most quickly, giving a prompt sensation of warmth.



Air flow distributed between footwell vents (hotter air) and central and side dashboard vents (cooler air). This air distribution setting is useful in spring and autumn on sunny days.



Air flow distributed between footwell vents and windscreen and front side window defrosting/demisting vents. This distribution setting allows the passenger compartment to be warmed effectively and prevents the windows from misting.



Air flow distribution between windscreen demisting/defrosting dashboard vents and side and central dashboard vents. This allows air to be sent to the windscreen in conditions of strong sunlight.



Air flow distribution to all vents on the vehicle.

In AUTO mode, the climate control system automatically manages the air distribution. When set manually, the air distribution is indicated by the respective symbols on the Connect system display switching on.

START&STOP EVO

The automatic dual-zone climate control system manages the Start&Stop Evo system (engine off and car is at a standstill) to ensure adequate comfort inside the car.

In particular, the climate control system turns off the Start&Stop Evo if:

- ❑ the climate control system is in AUTO mode (LED on the button switched on) and the temperature conditions inside the car are far from a comfort temperature;
- ❑ the climate control system is in LO maximum cooling;

- ❑ the climate control system is set to MAX-DEF.

When the Start&Stop Evo system is active (engine off and car stationary), the climate control system will request restarting of the engine if the inside temperature conditions rapidly deteriorate (or if the user requests maximum cooling – LO – or quick demisting – MAX-DEF).

With Start&Stop Evo function on (engine off and car stopped), the flow is reduced as much as possible, to keep the compartment comfort conditions for longer.

The electronic climate control system control unit attempts to manage the decreased comfort caused by switching off the engine as far as possible (switching off the compressor and engine coolant pump). However, it is possible to give priority to the climate control system by switching off the Start&Stop Evo by pressing the  button located on the dashboard controls to the left of the steering wheel.

In particularly severe climate conditions it is recommended to limit the use of the Start&Stop Evo system to prevent the compressor from continuously switching on and off, with consequent rapid misting of the windows and accumulation of

humidity with unpleasant smells in the passenger compartment.

When the state Start&Stop Evo is on (engine off and car at a standstill), the automatic recirculation management may be turned off to prevent the windows misting up, always taking air from outside, to reduce the probability of the windows misting up (as the compressor is off).

ELECTRIC WINDOWS



24)

They work with the ignition device in the ON position and for about 3 minutes after the ignition device has been turned to the STOP position. When one of the front doors is opened this operation is disabled.

Driver side front door controls

The buttons are located on the door panel trim. All windows can be controlled from the driver side door panel fig. 49.

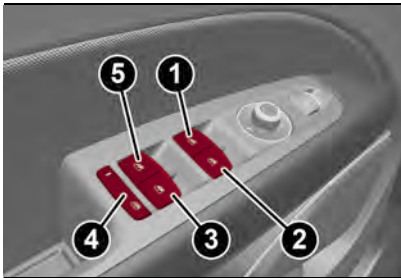

49

04166V0001EM

□ (1): left front window opening/closing. "Automatic continuous" operation during window opening/closing and anti-pinch system activated;

□ (2): right front window opening/closing. "Automatic continuous" operation during window opening/closing and anti-pinch system activated;

□ (3): right rear window opening/closing; "Automatic continuous" operation during window opening/closing and anti-pinch system activated;

□ (4): enabling/disabling of rear door electric window controls;

□ (5): left rear window opening/closing; "Automatic continuous" operation during window opening/closing and anti-pinch system activated.

Window opening

Push the buttons to open the desired window.

Each button has two position steps. Press gently (first position step) for manual "burst" window travel, while pressing the same button harder (second position step) activates "continuous automatic" operation.

If the button is pressed again, the window will stop in the desired position.

Window closing

Lift the buttons to close the desired window.

The window closing stage occurs following the same logic described for the opening stage both of the front door windows and the rear door windows.

Window anti-pinch safety device

This safety system can recognise the presence of any obstacle during the window closing movement. If this occurs, the system stops the window's movement and reverts it, depending on its position.

The anti-pinch safety function is activated both during the manual and the automatic operation of the window.

Electric window system initialisation

If power supply is interrupted, the electric window automatic operation must be reinitialised.

To perform the initialisation procedure, which must be done on each door with the doors closed, manually fully close the window to be initialised.



WARNING

24) Improper use of the electric windows can be dangerous. Before and during their operation, ensure that any passengers are not at risk from the moving glass either by personal objects getting caught in the mechanism or by being hit by it directly.



ABC

ELECTRIC SUNROOF

(where provided)



The electric sunroof comprises two glass panels (the front one is mobile and the rear one fixed) and is fitted with an electrically operated front sun blind and a manually operated rear sun blind.

Operation of the sunroof is only possible with the ignition device at AVV.

The sun roof has three preset positions: fully closed; comfort (intermediate opening) fully open.

WARNING You cannot have the blind closed when the roof is open.

OPENING

Press the button (1) fig. 50 at the word **OPEN**: the roof will open to the comfort position. A second press will open it fully.

A long press of the same button will open the roof until it is released, or if held down, until it reaches the comfort position. Use the button in the same way to open the roof fully from that position.



The automatic motion can be interrupted in any position by pressing button (1) again.

If the electric blind is closed, the roof opening control opens it too.

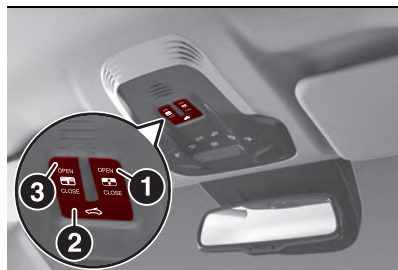

50

0418650075EM

CLOSING

From the fully open position, press the button (1) at the word **CLOSE**: the roof will close completely.

A long press of the same button moves the roof until it is released.

The automatic motion can be interrupted in any position by pressing button (1) again.

SWIVEL OPENING

To bring the roof into "swivel" position, press and release button (2) fig. 50.

This type of swivel opening can be activated irrespective of the position of the sun roof. When starting with the roof in closed position, pressing the button automatically causes its swivel-opening. If the roof is already open, pressing the button will open it to the swivel position.

Press button (2) again during automatic opening or closing to stop movement of the sunroof.

FRONT SUN BLIND ELECTRIC MOVEMENT

The front sun blind is electrically operated.

Press the button (3) fig. 50 at the word **OPEN** to open the sun blind.

Press the button (3) at the word **CLOSE** to close the sun blind.

The automatic motion can be interrupted in any position by pressing button (3) again.

If the roof is open, the sun blind closing control will also close the roof.

ANTI-PINCH DEVICE

The sunroof has an anti-pinch safety system capable of detecting the presence of an obstacle during the closing movement: if this happens, the system intervenes and the movement of the roof is immediately reversed into opening.

INITIALISATION PROCEDURE

Automatic operation of the sunroof must be initialised again in case of faulty sunroof operation.

WARNING The anti-pinch safety function is deactivated during the initialisation procedure.

Proceed as follows:

- Set the ignition device to AVV and start the engine;

- ❑ press the button (1) at the word **CLOSE** to bring the roof to the fully closed position;
- ❑ open the driver side door
- ❑ turn the ignition device to the STOP position;
- ❑ within 5 seconds, set the ignition device to AVV and start the engine;
- ❑ within 10 seconds press the button (1) at the word **CLOSE** and hold it down; after 10 seconds you will hear the electric motors of the roof and blind stop in sequence;
- ❑ release the button and within 5 seconds press the button (1) at the word **CLOSE** and hold it down (until the end of the cycle): the roof will automatically perform a complete open and close cycle including both the window and the blind (to indicate that the initialisation has been successful). If this does not occur, the procedure must be restarted from the beginning;
- ❑ check that the re-initialisation operation was successful by checking the “one touch” function of the window and blind.



WARNING

25) When leaving the car, make sure to take the key with you to avoid the risk of injury to those still inside the car due to accidental

operation of the sunroof. Improper use of the roof can be dangerous. Before and during operation, always check that no-one is exposed to the risk of being injured by the moving sunroof or by objects getting caught or hit by it.



IMPORTANT

10) Do not open the sun roof if a roof rack or crossbars are fitted. Do not open the sun roof if there is snow or ice on it: you may damage it.

BONNET

OPENING



Proceed as follows:

- ❑ from inside the passenger compartment, pull the release lever fig. 51;
- ❑ go to the outside of the vehicle and position yourself in front of the grille;
- ❑ slightly lift the bonnet and operate the release device from the side from the right leftwards as shown by the arrow, fig. 52;
- ❑ raise the bonnet completely: the operation is facilitated by the presence of two gas shock absorbers which hold it the all open position.



51

04196V0001EM



52

9490104

CLOSING



To close, lower the bonnet to approximately 40 centimetres from the motor compartment then let it drop. Make sure that the bonnet is completely closed and not only fastened by the locking device by trying to open it. If it is not perfectly closed, do not try to press the bonnet down but open it and repeat the procedure.



ABC

WARNING Always check that the bonnet is closed correctly to prevent it from opening while the vehicle is travelling. Since the bonnet is equipped with a double locking system, one for each side, you must check that it is closed on both its side ends.



WARNING

26) Perform these operations only when the car is stationary.

27) Use both hands to lift the bonnet. Before lifting, check that the windscreen wiper arms are not raised from the windscreen or in operation, that the car is stationary and that the electric parking brake is engaged.

28) For safety reasons, the bonnet must always be properly closed while driving. Therefore, make sure that the bonnet is properly closed and that the lock is engaged. If you discover that the bonnet is not perfectly closed while driving, stop immediately and close the bonnet in the correct manner.

TAILGATE

The tailgate is operated electrically, so pay the utmost attention before activating its movement.

Safe opening and closing of the tailgate is guaranteed by a protection system that can automatically stop its movement when it encounters an obstacle while opening or closing.

When the car is moving, tailgate unlocking and movement are disabled. To avoid difficulties in tight spaces, you can set the height at which to block the tailgate open.

Customising the tailgate opening height

To customise the tailgate opening position, proceed as described below:

- open the tailgate;
- manually move it to the position that you want to store;
- press one of the closing buttons (2) or (3), fig. 53 for at least 5 seconds (successful activation is indicated by the direction indicators flashing three times).

The tailgate is now programmed to open to the set position.

This function can be selected by acting on the Connect system fig. 54.



53

04056V0055EM



54

12126V2600EM

Setting the tailgate opening height to a preset position

(where provided)

To set the tailgate opening height to one of the four preset positions, proceed as follows:

- activate the Main menu on the Connect system and select the following functions in sequence: "Settings", "Doors and Locks" and "Electric Tailgate";

□ select one of the four pre-set positions and then press the graphic button to activate the selected position.

OPENING

WARNING A beeper always sounds while the tailgate is in motion.

Opening from the outside

When unlocked, you can open the tailgate from outside the car by pressing the electric opening button located between the number plate lights for about one second until you hear the unlocking click, or by pressing the button  on the remote control twice quickly.



55

04056V0005EM

The direction indicators will blink twice and the internal lights will switch on when the tailgate is opened. They switch off automatically when the tailgate is closed. The lights switch off automatically after a few minutes if the tailgate is left open.

Opening from the inside

When it is locked, the tailgate can be opened from inside the car by lifting the button (1) fig. 56 on the driver's door panel trim.

WARNING You can stop the tailgate moving by pressing the same button again.



56

04206V0002EM

EMERGENCY OPENING FROM INSIDE THE BOOT

There is a flap fig. 57 on the boot internal trim, next to the tailgate lock, accessible by folding down the rear seat backrest, which allows access to the manual lock opening cord.

Pull the cord to release the lock: the tailgate can now be lifted manually.



57

04206V0014EM

CLOSING

Closing from outside

It is possible to close the tailgate by pressing:

- the button (2) fig. 53 on the tailgate interior lining;
- the button (3) fig. 53 on the tailgate interior trim, (all the doors, including the tailgate, will be locked);
- the  button on the remote control twice quickly;
- the button fig. 55 on the tailgate, between the number plate lights.

WARNING It is possible to stop the tailgate moving with any of the close buttons.

Closing from inside

Press the button (1) fig. 56 on the plate on the driver's door panel and hold it down until the operation is complete.



ABC

WARNING It is possible to stop the tailgate moving by releasing the button.

AUTOMATICALLY OPENING AND CLOSING THE ELECTRICALLY OPERATED TAILGATE IN "HANDS-FREE" MODE

(where provided)

To operate the system in "hands-free" mode, proceed as follows:

- ❑ if the doors are locked or unlocked, the system must recognise the electronic key fob near the tailgate;
- ❑ go to the rear of the car, in the centre and about 50 cm from the tailgate;
- ❑ move your foot under the bumper, simulating a kick. When you have done this movement, withdraw your leg. To activate the movement, both sensors must detect your leg fig. 58.



58

9490200

If it is closed, the electrically operated/hands-free tailgate:

- ❑ unlocks and opens completely;
- ❑ with another movement of the foot, it stops;
- ❑ a further movement of the foot reverses the direction and closes the tailgate completely, if you do not stop it again.

If it is open, with a movement of the foot, the electrically operated/hands-free tailgate:

- ❑ closes completely;
- ❑ another movement of the foot before it closes completely will stop it;
- ❑ if the tailgate was stopped, another movement of the foot reverses the direction and opens it completely.

You can activate/deactivate the automatic tailgate opening and closing function in hands-free mode on the Connect system by activating the Main menu and selecting the following items in sequence: "Settings", "Doors and Locks" and "Automatic tailgate opening".

WARNING Before lifting the foot off the ground, make sure that you are in stable position. Do not touch any part of the car. There is a risk of injury from touching, for example, the very hot exhaust system.



WARNING To conserve the battery charge, avoid performing this operation repeatedly with the engine off.

WARNING To prevent accidentally opening the tailgate when washing the

car at a car wash station or using a high-pressure cleaner, use the Connect system to disable the "Automatic tailgate opening" function.

TAILGATE INITIALISATION

WARNING If the battery is disconnected or the protection fuse blows, the tailgate opening/closing mechanism must be reinitialised as follows:

- ❑ close all the doors and the tailgate;
- ❑ press the  button on the remote control;
- ❑ press the  button on the remote control.

INTERIOR FITTINGS

GLOVE COMPARTMENT



To open the compartment, use handle fig. 59.

WARNING Do not insert objects of such a size that the compartment cannot be completely closed. Moreover make sure that the compartment is completely closed while driving.

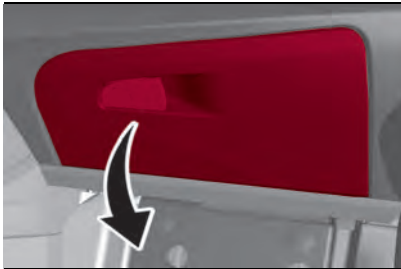

59

04246V0099EM

SUN VISORS

To direct the visor laterally, detach the visor from the interior rear-view mirror side hook and turn it towards the side window fig. 60.

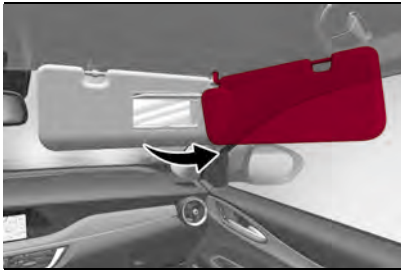

60

04246V0002EM

FRONT ARMREST

This is located between the front seats. There is a storage compartment inside the armrest: operate the fig. 61 device to access and raise the armrest.



61

04246V0004EM

CUP / CAN HOLDER

Two cup/can holders are available in the central tunnel fig. 62.



62

04246V0005EM

POWER SOCKETS

(where provided)

It is located on the central tunnel fig. 63 and inside the storage compartment on the central tunnel fig. 64. It only operates with the ignition device at ON.

It is possible to connect small battery-powered appliances that have a

maximum power of 150W (e.g. cameras, video cameras, tablets, razors, etc.) to the socket.

WARNING Do not connect devices with powers higher than 150W to the socket. Do not damage the socket by using unsuitable adaptors.



63

9490700



64

04026S0994EM

MOBILE PHONE COMPARTMENT

It is located on the passenger's door panel, in front of the door handle.



ABC



65

04246V0017EM

REAR CENTRAL ARMREST

The rear armrest is mobile and can be stored in the backrest.

- To lower it, pull on the tab located at the top.
- To re-close it, lift it until it is inserted in its housing.

There are two cup/can holders and a mobile phone compartment fig. 66 inside the armrest.



66

04246V0018EM

WARNING The armrest was not designed to support the weight of an adult passenger or a child. Only use it to hold drinks or small objects.

FIRE EXTINGUISHER

(where provided)

On some versions, there is a fire extinguisher in the luggage compartment.

For other versions/markets, the fire extinguisher is located under the glove compartment on passenger side fig. 67.



67

04246V0041EM



WARNING

29) Do not travel with the storage compartment open: it may injure the front seat occupants in the event of an accident.

WIRELESS CHARGING SYSTEM - WCPM (Wireless Charge Pad Module)

(where provided)

The car can be equipped with the Qi® wireless charger system (maximum power available 15 W), located in the housing in the front seat armrest fig. 68.

The Qi® wireless charger system is designed to wirelessly charge your mobile phone. Consult the manual of your phone to check its compatibility.

Qi® is a standard interface that uses electromagnetic induction to transmit electrical energy to a mobile device.

The mobile phone must be designed in accordance with the Qi® standard to be recharged through the WCPM system.

WARNING Keys must not be placed on the charging mat or within 15 cm from it. This could cause excessive heat buildup and damage to the remote control.

WARNING Placing the keys near the Wireless charger may prevent the engine from starting. In this case, a dedicated message will be shown on the display of the Connect system to alert the driver of the need to remove the object from the wireless charger.

WARNING Do not place the ignition key or any other type of metal or magnetized

object (e.g. credit cards, coins, etc.) inside the mobile phone housing.

WARNING Make sure that you place the mobile correctly (display facing downwards) in the special charging location: charging may not be enabled if it is in the wrong position.

WARNING To avoid interference with the key search, the wireless charger system stops charging when any door is opened.

WARNING Make sure that there are no metal objects between the phone and the wireless charger system during charging. Any such objects could overheat.



68

1116V0999EM

OPERATION

The wireless charging system is activated in automatic mode when the driver places his mobile phone in the housing (WCPM) (see the previous instructions), if the latter is compatible with the Qi® standard.

If the mobile phone is removed from the housing during the wireless charging

phase, this will automatically be interrupted.

The wireless charger system enables charging when all doors are closed properly and the engine has been started.

Interacting with the wireless charging system, positioning the mobile phone in the appropriate housing, the following messages are shown on the Connect system display (with specific icons and widgets), to inform the driver about the wireless charging system status:

- "Your phone is being charged": is displayed when the mobile phone is positioned correctly in the wireless charging compartment and the system is activated correctly;
- "Phone fully charged": is displayed when the phone has completed charging its battery;
- "Object not allowed": is displayed when a phone that is not enabled for wireless charging or an object that is not permitted (e.g. the ignition key) is placed.
- "Unavailable system": appears when there is a malfunction in the wireless charger system.

The driver can deactivate the display of messages relating to the operating status of the wireless charging system, using the relevant Connect system menu

(see the description on the dedicated supplement).

NOTE The use of multiple wireless functions on the smartphone at the same time (Apple CarPlay/Android Auto and wireless charging), as indicated by the smartphone manufacturers, could cause it to overheat, resulting in a limitation of the active functions or its turning off. In this case, it is recommended to connect the system using the USB socket.

ENVIRONMENTAL PROTECTION SYSTEMS

PETROL VERSIONS

The systems used for reducing petrol engine emissions are: catalytic converter, oxygen sensors, fuel evaporation control system and GPF particulate filter (petrol versions with GPF only).

DIESEL VERSIONS

The systems used for reducing diesel engine emissions are: exhaust gas recirculation system (EGR), oxidising catalytic converter, (DOC), selective nitrogen oxide catalytic converter with AdBlue® (SCR) and particulate filter (DPF).



30)



ABC

GASOLINE PARTICULATE FILTER GPF (Gasoline Particulate Filter) (petrol versions with GPF only)

The Gasoline Particulate Filter is a mechanical filter built into the exhaust system, which physically traps carbon particles present in the exhaust gases of petrol engines.

Since this filter physically traps particulate, it must be periodically regenerated (cleaned) at regular intervals by burning carbon particles.

The following may occur during regeneration: more noise and/or worsening of car handling.

These are not faults; they do not impair normal car performance or damage the environment. If the dedicated message is displayed, see contents of "Warning lights and messages" chapter in the "Knowing the instrument panel" section.

DIESEL PARTICULATE FILTER (DPF) (Diesel Particulate Filter)

The Diesel Particulate Filter is a mechanical filter, integral to the exhaust system, that physically traps carbon particles present in the exhaust gases of Diesel engines.

Since this filter physically traps particulate, it should be periodically regenerated (cleaned) at regular intervals by burning carbon particles.

During the regeneration there may be a limited increase in the engine idle speed, fan activation, a limited increase in fumes and high temperatures at the exhaust.

These are not faults; they do not impair normal car performance or damage the environment. If the dedicated message is displayed, see contents of "Warning lights and messages" chapter in the "Knowing the instrument panel" section.



WARNING

30) *The catalytic converter and particulate filter (DPF) reach very high temperatures during operation. Therefore do not park the vehicle on flammable materials (e.g. grass, dry leaves, pine needles, etc.): fire hazard.*



KNOWING THE INSTRUMENT PANEL

INSTRUMENT PANEL FEATURES	54
DISPLAY	60
TRIP COMPUTER	66
WARNING LIGHTS AND MESSAGES	68
EOBD SYSTEM (European On Board Diagnosis)	91

This section of the handbook provides all information that is useful for getting to know, interpreting, and using the instrument panel correctly.

INSTRUMENT PANEL FEATURES

"HERITAGE" DISPLAY

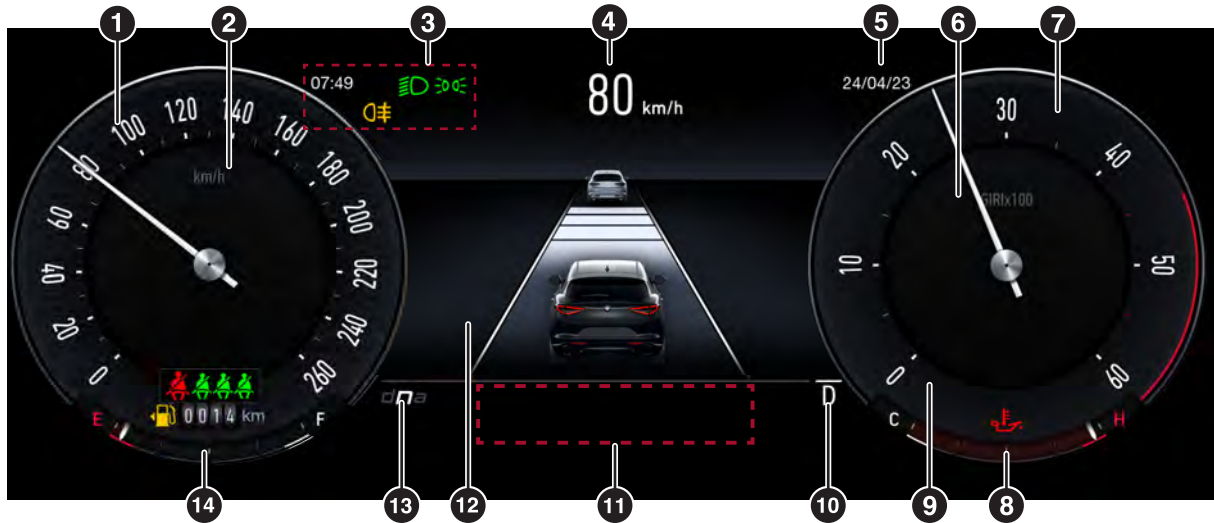

69

9490475

1. Speedometer / 2. Driving assistance system indications / 3. Customisable notification area, dipped/main beam headlight icons, side lights, rear fog light / 4. Instantaneous speed (numerical), driving assistance system notification icons / 5. Customisable notification area, engine torque limitation or external temperature display / 6. Customisable and notification area with pop-ups / 7. Tachometer / 8. Digital engine oil temperature indicator / 9. Notification icon display area / 10. Gear shift indicator (GSI - Gear Shift Indicator) / Automatic transmission information / 11. Menu title, screen navigation indications (e.g.: reset counters, customisation of information display, etc.) / 12. Main screen with driving assistance system notifications or car speed display / 13. Operating mode display: Dynamic, Normal, Advanced Efficiency / 14. Digital fuel level gauge, SBA (Seat Belt Alert) system indications, TPMS (Tyre Pressure Monitoring System) notification symbol

"EVOLVED" DISPLAY

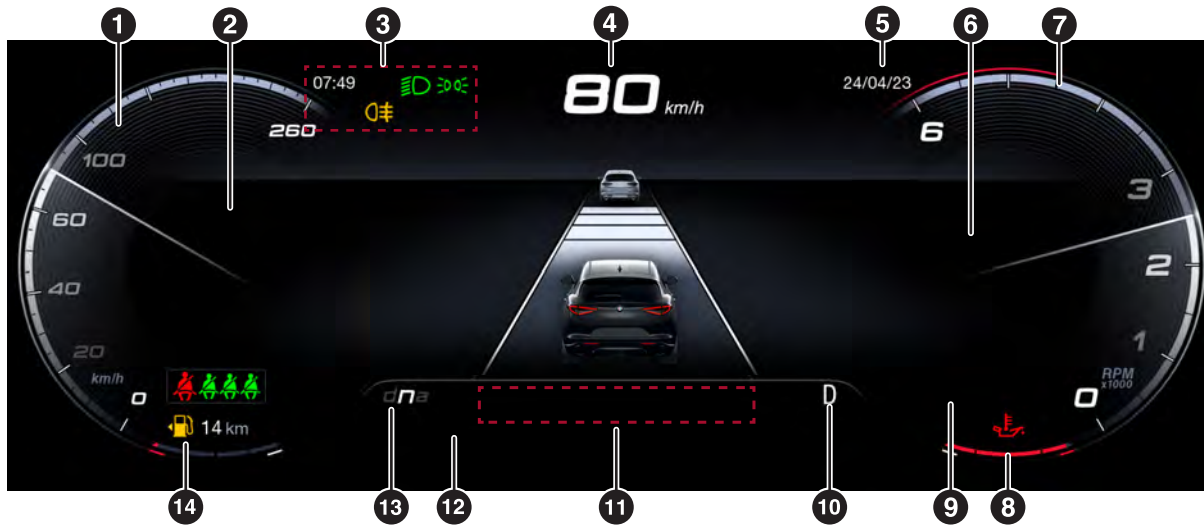

70

9490477

1. Speedometer / 2. Driving assistance system indications / 3. Customisable notification area, main beam/dipped beam headlights, side lights, rear fog lights icons, second instantaneous speed display / 4. Instantaneous speed (numerical), driving assistance system notification icons / 5. Customisable notification area, engine torque limitation or external temperature display 6. Customisable and notification area with pop-ups / 7. Tachometer / 8. Digital engine oil temperature indicator / 9. Notification icon display area / 10. Gear shift indicator (GSI - Gear Shift Indicator) / Automatic transmission information / 11. Menu title, screen navigation indications (e.g.: reset counters, customisation of information display, etc.) / 12. Main screen with driving assistance system notifications or car speed display / 13. Operating mode display: Dynamic, Normal, Advanced Efficiency / 14. Digital fuel level gauge, SBA (Seat Belt Alert) system indications, TPMS (Tyre Pressure Monitoring System) notification symbol



ABC

"RELAX" DISPLAY



71

9490433

1. Speedometer / 2. Driving assistance system indications / 3. Customisable notification area, dipped/main beam headlight icons, side lights, rear fog light / 4. Instantaneous speed (numerical), driving assistance system notification icons / 5. Customisable notification area, engine torque limitation or external temperature display 6. Customisable and notification area with pop-ups / 7. Tachometer / 8. Digital engine oil temperature indicator / 9. Notification icon display area / 10. Gear shift indicator (GSI - Gear Shift Indicator) / Automatic transmission information / 11. Menu title, screen navigation indications (e.g.: reset counters, customisation of information display, etc.) / 12. Main screen with driving assistance system notifications or car speed display / 13. Operating mode display: Dynamic, Normal, Advanced Efficiency / 14. Digital fuel level gauge, SBA (Seat Belt Alert) system indications, TPMS (Tyre Pressure Monitoring System) notification symbol

"Race" DISPLAY (where provided)

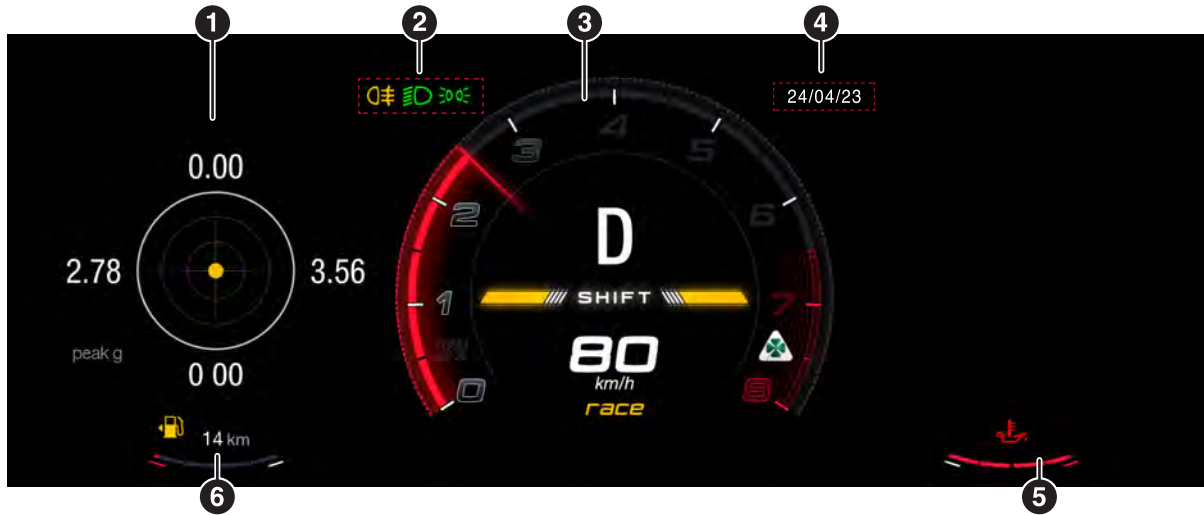

72

9490217

1. Display of longitudinal/lateral acceleration trend and peaks of lateral acceleration / 2. Customisable notification area, dipped/main beam headlight icons, side lights, rear fog light / 3. Gear shift indicator (GSI) / Automatic transmission information 4. Customisable notification area, engine torque limitation or external temperature display 5. Notification icon display area / 6. Digital fuel level gauge, SBA (Seat Belt Alert) system indications, TPMS (Tyre Pressure Monitoring System) notification symbol



ABC

DESCRIPTION OF THE INSTRUMENT PANEL

NOTE The "Heritage", "Evolved" and "Relax" views can be set by pressing the "MENU VIEW" button fig. 73 on the right-hand shift paddle. The 'Evolved' display is the default setting.

NOTE The "Race" display is set by selecting the "Race" mode on the Alfa DNA™ Pro system. With the "Race" display set, the speedometer and "Driver Assistance" screens are deactivated (only the Widget selection screen is active). It is also not possible to change the graphic display by pressing the "MENU VIEW" button on the right-hand steering wheel lever.

NOTE The graphics of the "Heritage" and "Evolved" displays may vary depending on the set-up.



73

9490235

SPEEDOMETER

The instantaneous speed of the car (in km/h or mph) is displayed in this position, which can also be displayed at the top of the display.

Press the ring fig. 74 to switch between km/h and mph scales.

NOTE In the "Natural" driving mode, only the instantaneous speed, minimum speed (0 km/h) and maximum speed at full scale are displayed on the scale. The colour of the speedometer may vary according to the driving mode set by the Alfa DNA™ Pro system.

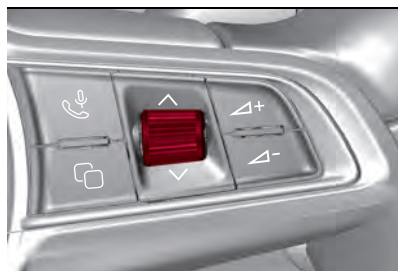

74

9550195

For versions/markets, where applicable, the secondary speed can also be shown on the instrument cluster display.

With "Evolved" display active, three different graphic animations are provided:

- with "Dynamic" mode active on the graphic scale of the speedometer and

rev counter all numbers are displayed fig. 75;

- with "Natural" or "Advanced Efficiency" mode active, the speed and engine speed value will only be displayed when they are reached or exceeded fig. 76;

- the value "0", maximum speed and engine speed are always displayed.



75

9550400



76

9550401

Active Cruise Control (ACC) / HAS system (Highway Assist) / TJA system (Traffic Jam Assist) information display

When Active Cruise Control (ACC), HAS (Highway Assist) or TJA (Traffic Jam Assist) are active, a dedicated icon is displayed at the top of the tachometer, which can be white (with device/systems enabled and paused) or green (with device/systems active) fig. 77.



77

9550240

TACHOMETER

This indicates the rpm of the engine expressed in revolutions per minute. "X 1000" or "X 100".

NOTE In the "Natural" driving mode, only the instantaneous speed, minimum speed (0 rpm) and maximum speed at full scale are displayed on the scale. The colouring of the indicator (1) fig. 78 may vary depending on the driving mode set via the Alfa DNA™ system.



78

9550502

DIGITAL FUEL LEVEL GAUGE

The digital indicator fig. 79 displays the level of fuel still available in the tank and the estimated indicative range.

The triangle to the side of the symbol indicates the side of the car with the fuel filler.

The symbol turns yellow when the level has reached the fuel reserve, while the mark at the bottom of the scale turns red fig. 80.

The indications next to the graphic scale indicate the amount of fuel:

- F (Full) = full tank
- E (Empty) = empty tank



79

9550229



80

9550230

WARNING If the reserve switches on, refuel at the earliest opportunity.

WARNING Do not travel with the fuel tank almost empty: possible gaps in fuel supply could damage the catalytic converter.

ENGINE OIL TEMPERATURE GAUGE

The digital indicator fig. 81 displays the temperature of the engine lubrication oil. When the temperature is too high, the icon and the indicator turn red.



ABC



81

9550228

INSTRUMENT PANEL LIGHT ADJUSTMENT (brightness sensor)

Inside the tachometer there is a light sensor capable of detecting environmental light conditions and adjusting the operating mode (night/day) and the brightness of the instrument panel and the Alfa Connect system display.

DISPLAY

A welcome screen appears on the instrument panel display, fig. 82 upon entering the passenger compartment.

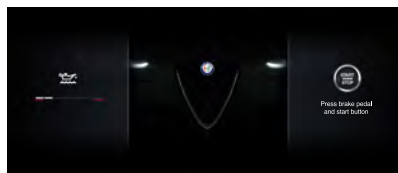

82

9550504

CENTRAL SCREEN

The following information is displayed in the central area of the display fig. 83:

- Speedometer (numeric indication)
- Navigation (where provided)
- Performance
- Driver Assist
- Messages and stored message list

NOTE In "Race" mode, only "Performance" information and the "Messages and stored message list" will be displayed.

NOTE Turn the ignition device from the STOP position to the MAR position to display the last active screen before the engine is switched off.



83

9550170

NAVIGATION BETWEEN SCREENS

Press the button (2) fig. 84 and turn the ring (1) up or down to scroll through the screens.

If the selected screen permits, press the ring to access the submenus (1).

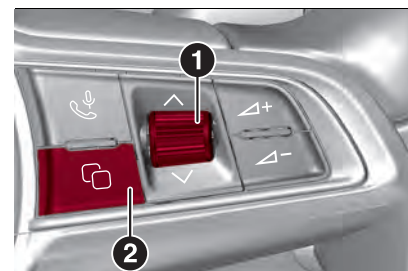

84

9550169

SPEEDOMETER

The following information fig. 85 is displayed on this screen:

- (1): instantaneous speed in km/h or

mph. Press the ring (1) fig. 84 to switch between km/h and mph scales.

- (2): selected driving mode.
- (3): messages.
- (4): engaged gear and GSI (Gear Shift Indicator) shift suggestions.

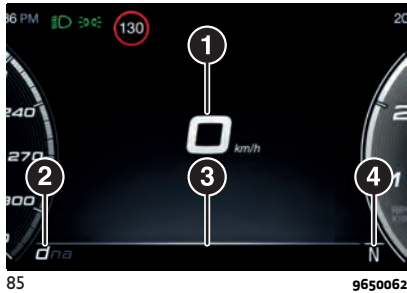

NAVIGATION

(where provided)

This screen can be used to repeat the indications provided by the Alfa Connect system navigator on the right-hand dial of the instrument panel display.

Zoom changes made on the Alfa Connect system are not automatically repeated on the instrument panel display screen.

Turn the ring up/down (1) fig. 84 to increase/decrease the zoom on this screen. Press the ring to go back to the initial frame. The zoom level is automatically reset to the factory settings whenever the engine is started.

If the function is activated using the Alfa Connect system settings, the navigator indications of the Alfa Connect system are also repeated within the right dial of the display (1) fig. 86 by means of turn by turn instructions.

The following information is shown:

- (1): direction indicators
- (2): distance to next change of direction (in km or miles, depending on instrument panel settings)
- (3): suggested lanes
- (4): address of the road to be followed after the change of direction

Press and hold the ring (1) fig. 84 to disable the indications in the right-hand meter for the current navigation.



With navigation active outside the "Navigation" screen, turn indications are displayed in the lower area of the instrument cluster display in a pop-up

message each time the navigator suggests a change of direction.

NOTE It is only possible to display the repetition of navigation directions from the native navigator of the Alfa Connect system. The repetition of directions provided by apps on the device connected to the Alfa Connect system through Android Auto, Apple CarPlay or Baidu CarLife (for versions/markets, where provided) is not supported.

PHONE

WARNING The Alfa Connect system supports the pairing of two phones at the same time but during the call only the phone currently in use will be displayed on the screen.

To start a call, proceed as follows:

- press the ring (1) fig. 84 to access the phone list
- select the desired connected phone by turning the ring up or down, then press the ring again. To exit the screen, select "Exit";
- to initiate the call to the desired phone number, select the contact by turning the ring up or down, then press the ring again. To cancel without making a call and return to the phone list, select "Exit".

The screen displays the status of the call (fig. 87, fig. 88):

(1) Incoming call



ABC

- (2) Outgoing call
- (3) Any second simultaneous call and its status (on-hold, outgoing, incoming, in progress, ended)
- (4) Call in progress
- (5) Call ended

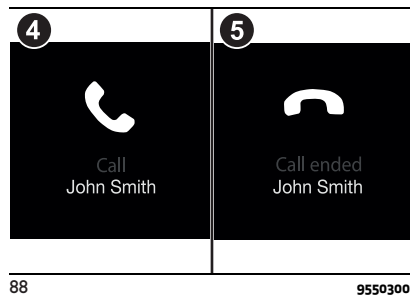
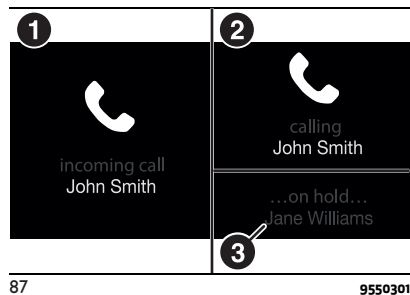

The screen also displays the arrival of a message using the symbol .

According to the display settings, an incoming call can be notified via a pop-up screen in the tachometer dial fig. 89.

62

The pop-up screen shows the following information:

- the name of the contact (or the phone number if the contact is not stored on the phone)
- the image of the contact, if any (if associated with the contact stored on the phone)
- the name of the telephone on which the call is being received (only if two telephones are connected at the same time)

Press the button  or the ring (1) fig. 84 on the steering wheel to accept the incoming call.

The pop-up screen remains displayed until the call is accepted or the caller ends the call.

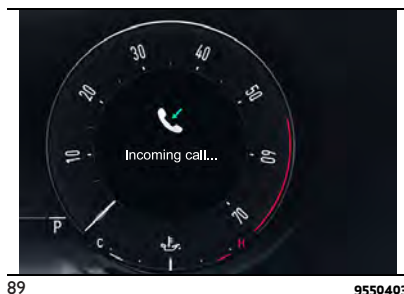

PERFORMANCE

According to the mode selected using the Alfa DNA™ system selector, the

screen shows the acceleration or fuel consumption of the car.

Refer to the "Alfa DNA™ System" chapter in the "Starting and driving" section for more information

"DYNAMIC" MODE

The vehicle stability parameters are displayed.

The graphs illustrate the trend of the longitudinal/lateral accelerations (G-meter information), considering gravity acceleration as a reference unit.

Lateral acceleration peaks are displayed on the right fig. 90.



"NATURAL" MODE

The average consumption value and instantaneous consumption value are displayed fig. 91.



91

9550174

DRIVER ASSIST

The screen at fig. 92 shows the status and settings of the driving assistance Active Cruise Control, Lane Keeping Assist and Traffic Jam Assist systems.

For further information see the respective chapters in the "Safety" and "Starting and driving" sections.

Any instant notifications are displayed via a pop-up screen.

The units of measurement (metric or imperial) depend on the units defined using the display settings.



92

9490333

MESSAGES AND STORED MESSAGE LIST

Messages shown on the display using pop-up screens are stored as long as they remain valid.

They can be view later in the central area of the "Messages" screen (1) fig. 93.

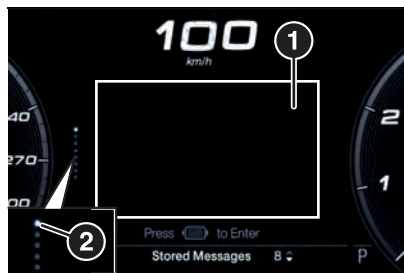

93

9550438

If multiple messages are present:

- press the ring (1) fig. 84 to access the message list

- scroll through the previous/next messages by turning the ring up/down (1) upwards/downwards. The position of the displayed message within the list is indicated by the light spot (2) fig. 93. Presence of previous/next messages is indicated by grey dots

CUSTOM AREAS

The right dial (tachometer) (2) fig. 94 and left dial (speedometer) (1) of the instrument panel can be customised to display additional information using the "Settings" function of the Alfa Connect system.

One of the following can be selected for each dial:

- Time
- Date
- External temperature
- Compass (where provided)
- Empty

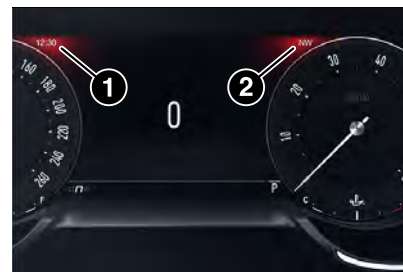

94

9550404



ABC

NOTE The date and time format and the unit of measurement of the external temperature depend on the settings defined using the Alfa Connect system.

NOTE It is not possible to display the same information in two different dials: setting the same content in one dial will remove the information from the other.

NOTE If the repetition of the navigation is deactivated (see the paragraph "Navigation"), even if the compass is shown on the instrument panel display, it is not active.

When the engine is switched off, the last customisation set is stored and is displayed the next time the engine is started.

WIDGETS

The right-hand dial (tachometer) of the instrument panel can be customised with alternative information to that described in the previous paragraph "Custom areas" using graphic elements known as "Widgets".

To scroll through the set widgets, press the button (2) fig. 84 on the steering wheel controls and then turn the ring (1).

The following widgets can be displayed:

❑ Media, which displays the following, according to the type of information played by the Alfa Connect system:

- album thumbnail, source, song title, artist, any connected phone information, or:
- album thumbnail or radio station logo, station name, frequency, any information on the connected phone



95 9650081

- ❑ Trip A, Trip B (if present) fig. 96, distance travelled, average consumption on trip, trip time, average speed, odometer, AdBlue® level (Diesel versions only) inside tank
- ❑ Compass (where provided) fig. 97



96 9550405



97 9650082

NOTE The Compass is displayed automatically if Trip B is disabled using the display settings. Trip B, if enabled, automatically replaces the compass display.

❑ Tyre pressure measured by the TPMS (Tyre Pressure Monitoring System)



98

9550168

POP-UP SCREENS

Under certain driving conditions, messages or pop-up screens may be automatically displayed on the right-hand dial to alert the driver to useful driving information (grey background, e.g. notification of open doors, open bonnet and/or tailgate, fig. 99), low priority warnings (yellow background) or high priority warnings (red background, e.g. a braking indication, fig. 100).

Where applicable, the pop-up screen display may be accompanied by an acoustic signal and one or more warning lights (or symbols) on the instrument panel display.



99

9550408

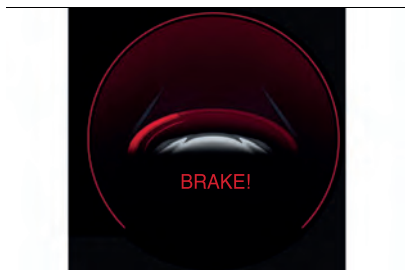

100

9650080

NOTE In the case of two or more simultaneous events displaying a pop-up screen, the screens are displayed in sequence and in order of priority: first those with a higher priority (red background), then those with a lower priority (yellow background) and then those with information (grey background).

The pop-up screen can be closed by holding the ring (1) fig. 84 pressed.

If the engine is shut down with one or more faults present, pop-up warning screens will be displayed the next time the engine is restarted if these faults have not been solved in the meantime.

ENGINE OIL LEVEL DISPLAY

The car is provided with an engine oil level display system, fig. 101.

The oil level graphic bar, on the left-hand side of the dial, is displayed when starting/stopping the engine.

NOTE If the maximum engine oil level is exceeded, all marks and the symbol  will be displayed in red. A dedicated message will appear on the instrument panel display.

NOTE If the engine oil level is low, the last notch and the symbol  will be displayed in red. A dedicated message will appear on the instrument panel display.



101

9550231



ABC

ENGINE OIL CHANGE INDICATOR SYSTEM

(where provided)

The car is equipped with an engine oil change indicator system.

A dedicated message appears on the instrument panel display for a few seconds to indicate the next scheduled oil change interval.

The engine oil of the indicator system is duty cycle based, which means the engine oil change interval may fluctuate, dependent upon your personal driving style.

GEAR SHIFT INDICATOR

(where provided)

The Gear Shift Indicator (GSI) system advises the driver to change gear through a special indication on the display fig. 102.

Through the GSI system, the driver is informed that shifting gear will allow a reduction in fuel consumption.

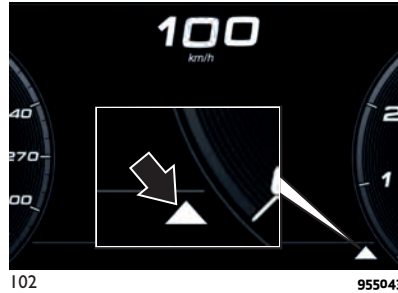

Icon  on the display: suggestion to shift up a gear.

Icon  on the display: suggestion to shift to two higher gears (double shift).

Icon  on the display: suggestion to shift to a lower gear.

Icon  on the display: suggestion to shift to two lower gears (double shift).

The indication in the display remains until a gear is shifted or the driving conditions go back to a situation where gearshifting is not required to improve consumption.

When there are no gear shift suggestions, the engaged gear is displayed (P, R, N, D, M)

TRIP COMPUTER

The "Trip Computer" is used to display information on car operation when the ignition device is at MAR.

To display the Trip Computer, set it up as a widget on the right dial (tachometer) of the instrument panel fig. 103.



The "Trip Computer" has two separate memories, "Trip A" and "Trip B", where the data for the car's "complete journeys" (trips) is recorded independently from each other. Press and release the button (2) fig. 104 button on the steering wheel controls until the "Trip A" or "Trip B" widget is highlighted on the instrument panel.

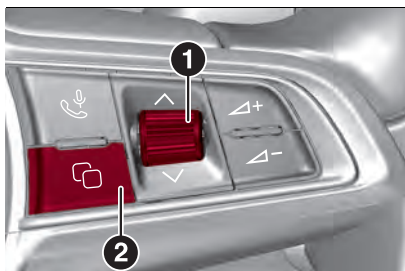

104

9550194

The Trip Computer can display the following information fig. 103:

- odometer (1);
- average fuel consumption (2);
- average speed (3);
- total distance travelled according to the trip meter since the last reset (4);
- the expected range before an AdBlue® top-up is required (5);
- the elapsed time since the trip meter was last reset (6).

Actual running time

This indicates the total time travelled since the last reset. The time is increased when the ignition device is in the AVV position.

Reset Trip

Hold the ring (1) fig. 104 pressed to clear the displayed resettable function value.



ABC

WARNING LIGHTS AND MESSAGES

WARNING The warning light switches on in the instrument panel together with a dedicated message and/or acoustic signal when applicable. These indications are indicative and precautionary and as such must not be considered as exhaustive and/or alternative to the information contained in the Owner Handbook, which you are advised to read carefully in all cases. Always refer to the information in this section in the event of a failure indication.









WARNING The failure indicators appearing on the display are divided into two categories: very serious and less serious failures. Serious faults are indicated by a repeated and prolonged warning "cycle". Less serious faults are indicated by a warning "cycle" with a shorter duration. You can stop the warning cycle in both cases by pressing the button located on the windscreen wiper lever. The instrument panel warning light will stay on until the cause of the failure is eliminated.

WARNING LIGHTS ON INSTRUMENT PANEL

Possible detailed messages and/or acoustic signalling can be matched to a few warning lights and symbols.

Red warning lights

Warning light	What it means
	<p>INSUFFICIENT BRAKE FLUID / ELECTRIC PARKING BRAKE ON</p> <p>The warning light switches on when the ignition device is brought to MAR, but it should switch off after a few seconds.</p> <p>Low brake fluid level</p> <p>The warning light turns on when the level of the brake fluid in the reservoir falls below the minimum level, possibly due to a leak in the circuit. Restore the brake fluid level, then check that the warning light has switched off. If the warning light stays on, contact an Alfa Romeo Dealership.</p> <hr/> <p>Electric parking brake on</p> <p>The warning light switches on when the electric parking brake is engaged. In the event of failure, the warning light flashes for about 10 seconds and then turns off. Release the electric parking brake, then check that the warning light has switched off. If the warning light stays on, contact an Alfa Romeo Dealership.</p> <p>If the car is parked on a gradient of more than 30% and/or the brake temperature is greater than 662°F (350°C), when the parking brake is engaged, the warning light will flash to indicate a potentially unsafe condition.</p>



Warning light	What it means
 	<p>EBD FAILURE</p> <p>The simultaneous switching on of the  (red) and  (amber) warning lights with the engine on indicates either a failure of the EBD system or that the system is not available. In this case, the rear wheels may suddenly lock and the vehicle may swerve when braking sharply.</p> <p>Drive very carefully to the nearest Alfa Romeo Dealership to have the system inspected immediately.</p>
	<p>POWER STEERING FAILURE (where provided)</p> <p>The warning light (where provided) switches on when the ignition device is brought to MAR, but it should switch off after a few seconds.</p> <p>If the warning light remains on, you could not have power steering and the effort required to operate the steering wheel could be increased; steering is, however, possible.</p> <p>Contact an Alfa Romeo Dealership as soon as possible.</p>
	<p>AIRBAG FAILURE</p> <p>If the warning light switches on constantly, this indicates a failure in the airbag system.</p> <p> 31) 32)</p>
	<p>ALTERNATOR FAILURE</p> <p>The switching on of the warning light with engine on indicates to an alternator failure. Contact an Alfa Romeo Dealership as soon as possible.</p>
	<p>DOORS OPEN</p> <p>The warning light switches on when one or more doors are not completely shut. A pop-up screen appears highlighting in red the door(s) that have not been closed properly instead of the tachometer dial. An acoustic warning is activated with the doors open and the car moving. Close the doors properly.</p>









WARNING

31) If the  warning light does not switch on when the ignition device switch is moved to MAR or if it stays on while driving (together with the message on the display), there might be a fault in the restraint systems; in this case, the airbags or pretensioners may not deploy in the event of an accident or, in a lower number of cases, they could deploy erroneously. Before proceeding, contact an Alfa Romeo Dealership to have the system checked immediately.



32) The failure of the  warning light is signalled by the switching on of the  symbol on the instrument panel. In this case, the warning light may not indicate problems with the restraint systems. Before proceeding, contact an Alfa Romeo Dealership to have the system checked immediately.



Amber warning lights

Warning light	What it means
	<p>ABS (Anti-lock Braking System) FAILURE</p> <p>The warning light switches on to indicate an ABS (Anti-lock Braking System) fault. In this case the braking system maintains its efficiency unaltered but without the advantage of the ABS system. Drive carefully and contact an Alfa Romeo Dealership as soon as possible.</p>
	<p>ESC (Electronic Stability Control) SYSTEM</p> <p>ESC system activation</p> <p>Intervention by the system is indicated by the flashing of the warning light: it indicates that the car is in critical stability and grip conditions.</p> <hr/> <p>ESC system failure</p> <p>If the warning light does not switch off, or if it stays on with the engine on, a failure was found in the ESC system. Contact an Alfa Romeo Dealership as soon as possible.</p> <hr/> <p>Hill Start Assist failure</p> <p>The warning light switches on to indicate a Hill Start Assist system failure. Contact an Alfa Romeo Dealership as soon as possible.</p>

Warning light	What it means
	<p>PARTIAL / TOTAL DEACTIVATION OF ACTIVE SAFETY SYSTEMS</p> <p>When the ignition device is brought to ON, the warning light switches on, but should switch off as soon as the engine is started.</p> <p>The warning light switches on to indicate that some active safety systems have been partially or totally deactivated. When the systems are reactivated, the warning light switches off.</p> <p>For further details about the active safety systems see the "Active safety systems" chapter in the "Safety" section. When the active safety systems are reactivated, the warning light switches off.</p>
	<p>FCW (Forward Collision Warning) SYSTEM FAILURE</p> <p>The warning light turns on to indicate a failure in the Forward Collision Warning system. Contact an Alfa Romeo Dealership as soon as possible.</p>
	<p>FCW (Forward Collision Warning) SYSTEM DEACTIVATION</p> <p>The warning light turns on if the Forward Collision Warning system has been deactivated or if the system is obstructed/dirty/unavailable.</p>





Warning light	What it means
	<p>EOBD / INJECTION / CATALYST DAMAGE (petrol versions with GPF)</p> <p>In normal conditions, when the ignition device is brought to ON, the warning light switches on, but it should switch off as soon as the engine is started.</p> <p>The operation of the warning light may be checked by the traffic police using specific devices. Comply with the laws and regulations of the country where you are driving.</p> <p>Injection system failure</p> <p>If the warning light remains on, or it switches on whilst driving, the injection system is not working properly.</p> <p>The warning light on constantly signals a malfunction in the supply/ignition system which could cause high exhaust emissions, a possible loss of performance, poor driveability and high consumption.</p> <p>The warning light switches off if the malfunction disappears, but is still stored by the system.</p> <p>Under these conditions, you can continue travelling at moderate speed but without demanding excessive effort from the engine or high speed. Prolonged use of the car with the warning light on constantly may cause damage. Contact an Alfa Romeo Dealership as soon as possible.</p> <p>Catalytic converter damage</p> <p>If the warning light flashes, it means that the catalytic converter may be damaged. Release the accelerator pedal to lower the speed of the engine until the warning light stops flashing.</p> <p>Continue the journey at moderate speed, trying to avoid driving conditions that may cause further flashing and contact an Alfa Romeo Dealership as soon as possible. ⚠️ 11)</p>
	<p>AdBlue® (UREA) INJECTION SYSTEM FAILURE (Diesel versions)</p> <p>In normal conditions, when the ignition device is brought to MAR, the warning light switches on, but it should switch off as soon as the engine is started.</p> <p>The warning light appears if a fluid not conforming with nominal features is introduced or if an average AdBlue® (UREA) consumption of over 50% is detected.</p> <p>In this case, contact an Alfa Romeo Dealership as soon as possible.</p> <p>If the problem is not solved, a dedicated message will appear on the instrument panel display whenever the next threshold is reached, until it is no longer possible to start the engine.</p> <p>When there are approximately 124 miles (200 km) before you can no longer restart the engine, on some versions a dedicated message will appear fixed on the instrument panel display accompanied by warning tone.</p>

Warning light	What it means
	<p>ELECTRIC PARKING BRAKE FAILURE (where provided)</p> <p>In normal conditions, when the ignition device is brought to MAR, the warning light switches on, but it should switch off as soon as the engine is started.</p> <p>The warning light turns on to indicate a failure in the electric parking brake system.</p> <p>This failure could partially or completely block the car because the electric parking brake could remain activated even if automatically or manually disengaged using the relevant controls.</p> <p>If the car can still be used (electric parking brake not engaged), drive carefully to the nearest Alfa Romeo dealership, remembering that the electric parking brake will not work.</p> <p> 33)</p>

 **WARNING**

33) *If a failure is present with sharp braking, the rear wheels may lock and the vehicle may swerve.*

 **IMPORTANT**

11) *If, turning the ignition device to MAR, the  warning light does not turn on or if it turns on steadily or flashing while driving (on some versions together with the message on the display), contact an Alfa Romeo Dealership as soon as possible.*

Green warning lights

Warning light	What it means	What to do
	<p>LEFT DIRECTION INDICATOR</p> <p>The warning light switches on when the direction indicator stalk is moved upwards or, together with the left direction indicator, when the hazard warning light button is pressed.</p>	







Warning light	What it means	What to do
	<p>RIGHT DIRECTION INDICATOR The warning light switches on when the direction indicator stalk is moved upwards or, together with the left direction indicator, when the hazard warning light button is pressed.</p>	

Warning light	What it means
	<p>BRIGHTNESS SENSOR This warning light on the odometer lights up in the event of the brightness sensor activation.</p>

Warning	What it means
<p>All warning lights off</p>	<p>INSTRUMENT PANEL DISPLAY FAILURE All warning lights remain off in the event of an instrument panel display failure. In this case, contact an Alfa Romeo Dealership.</p>
<p>Message to have the warning light checked</p>	<p>CONTROL SYSTEM WARNING LIGHT FAILURE Failure of the control system warning light is indicated by a dedicated message appearing on the instrument panel display. In this case, contact an Alfa Romeo Dealership.</p>









SYMBOLS ON THE DISPLAY



Red Symbols

Symbol	What it means
	<p>LOW ENGINE OIL PRESSURE</p> <p>The symbol appears if the engine oil pressure is low.  12)</p> <p>If it turns on temporarily or flashes (for about 5 seconds), check the oil level by following the corresponding procedure (see the description in the "Checking levels" chapter in the "Maintenance and care" section) and top up to the correct level if necessary.</p> <p>If the symbol appears continuously, contact an Alfa Romeo Dealership to have the system checked.</p> <p>WARNING IF THE SYMBOL TURNS ON CONTINUOUSLY: Do not use the car until the failure has been solved. When the symbol turns on, it does not indicate the amount of oil in the engine: the oil level can be checked on the display upon entering the vehicle and also by activating the "Oil level" function on the Alfa Connect system.</p>
	<p>INSUFFICIENT ENGINE OIL LEVEL</p> <p>The symbol switches on to indicates a low engine coolant level condition. Top up the oil as soon as possible to restore the correct level in the sump (see "Engine compartment - Checking the levels" chapter in the "Maintenance and care" section for information on the quantity to be top up).</p> <p>You may carry out this operation on your own, using a suitable type of oil, as prescribed by Alfa Romeo (see the "Fluids and lubricants" chapter in the "Technical specifications" section for detailed information).</p> <p>Quadrifoglio version: the level must also be checked using the dipstick under the bonnet (see the "Servicing and care" section).</p> <hr/> <p>OIL OVER MAXIMUM LEVEL</p> <p>If the symbol switches on, it indicates an excessive engine coolant level condition.</p> <p>Go to an Alfa Romeo dealership as soon as possible to have the correct level restored. Run the engine under 3000 rpm during this time.</p>
	<p>SEAT BELTS REMINDER</p> <p>The symbol appears fixed if the car is stationary and the seat belt of the driver, front passenger or rear passengers is not fastened with an occupant in the seat.</p> <p>The symbol flashes and an acoustic warning will sound if the car is in motion and the seat belt of the driver, front passenger or rear passengers is not correctly fastened with an occupant in the seat. In this case, fasten the seat belt.</p>



ABC

Symbol	What it means
	<p>ENGINE COOLANT TEMPERATURE TOO HIGH</p> <p>The symbol lights up when the engine has overheated.</p> <p>In normal driving conditions: stop the car, switch off the engine and check that the water level in the reservoir is not below the MIN mark. In this case, wait for the engine to cool down, then slowly and carefully open the cap, top up with coolant and check that the level is between the MIN and MAX marks on the reservoir itself. Also check visually for any fluid leaks. Contact an Alfa Romeo Dealership if the symbol appears on the display when the engine is started again.</p> <p>If the car is used under demanding conditions (e.g. in high-performance driving): slow down and, if the warning light stays on, stop the car. Wait for 2 or 3 minutes with the engine running and slightly accelerated to further favour the coolant circulation. Then stop the engine. Check that the coolant level is correct as described above.</p> <p>WARNING Over demanding routes, it is advisable to keep the engine on and slightly accelerated for a few minutes before switching it off.</p>
	<p>EXCESSIVE ENGINE OIL TEMPERATURE</p> <p>The symbol appears in the case of engine oil overheating.  13)</p>
	<p>BONNET NOT PROPERLY SHUT</p> <p>The symbol appears when the bonnet is not properly shut. Instead of the tachometer, a pop-up screen appears highlighting the bonnet in red. A buzzer is heard when the bonnet is open and the car is moving. Close the bonnet properly.</p>
	<p>TAILGATE NOT COMPLETELY SHUT</p> <p>The symbol switches on when the tailgate is not properly shut. A pop-up screen appears highlighting the tailgate in red instead of the tachometer dial. A buzzer is heard when the tailgate is open and the car is moving. Close the tailgate correctly.</p>
	<p>AUTOMATIC TRANSMISSION FAILURE</p> <p>The symbol appears, together with an acoustic warning, to indicate that the automatic transmission is faulty. Contact an Alfa Romeo Dealership as soon as possible.  14) 15)</p>
	<p>ALFA™ SYSTEM STEERING TORQUE (AST) FAILURE</p> <p>The switching on of the symbol, along with a message signals a failure in the AST system ("Alfa™ Steering Torque") automatic steering correction system). Contact an Alfa Romeo Dealership as soon as possible.</p>

Symbol	What it means
	BRAKE DISC TEMPERATURE When the symbol appears, it indicates an excessive temperature of the brake discs. Let the braking system cool down by reducing the speed.
	DAA (Driver Attention Assist) SYSTEM ACTIVATION (where provided) The symbol appears on the instrument panel display when the DAA (Driver Attention Assist) system is activated. The system, after estimating the driver's drowsiness level, through specific events, suggests to the driver to stop for a break, because continuing driving is risky. Stop to pause while driving, pulling the car over in safe conditions.

 **IMPORTANT**

12) If the symbol  switches on while driving, stop the engine immediately and contact an Alfa Romeo Dealership.

13) If the symbol switches on while driving, stop the car and the engine immediately.





14) Driving the vehicle with this symbol on may severely damage the transmission, with resulting breakage. The oil may also overheat: contact with hot engine or with exhaust components at high temperature could cause fires.









15) During normal use, the symbol may turn on when the gear lever is in an intermediate position between two gears for around ten seconds: the symbol will turn off when the gear lever is engaged correctly. If the problem persists, contact an Alfa Romeo Dealership.

Amber symbols









Symbol	What it means
	TPMS (Tyre Pressure Monitoring System) TPMS failure If a TPMS failure is detected, the symbol flashes for about 75 seconds and then stays on fixed. WARNING Do not continue driving with one or more flat tyres as handling may be compromised. Stop the car, avoiding sharp braking and steering. Repair immediately using the dedicated The Tyre Repair Kit is and contact an Alfa Romeo Dealership.













Symbol	What it means
	<p>Low tyre pressure</p> <p>The symbol appears to indicate that the tyre pressure is lower than the recommended value and/or that slow pressure loss is occurring. In these cases, optimal tyre duration and fuel consumption may not be guaranteed.</p> <p>Should two or more tyres be in the condition mentioned above, the display will show the indications corresponding to each tyre in sequence.</p> <p>In any situation in which the message on the display is "See manual", it is ESSENTIAL to refer to the contents of the "Wheels" chapter in the "Technical specifications" SECTION, strictly complying with the indications that you find there.</p>
	<p>ENGINE IMMOBILIZER FAILURE / BREAK-IN ATTEMPT</p> <p>Engine Immobilizer system failure</p> <p>The symbol appears to report a failure of the Engine Immobilizer system. Contact an Alfa Romeo Dealership as soon as possible.</p> <p>Break-in attempt</p> <p>The symbol appears when moving the ignition device to MAR, to indicate a possible break-in attempt detected by the alarm system.</p> <p>Electronic key not recognised</p> <p>The symbol appears when the engine is started and the electronic key is not recognised by the system. Contact an Alfa Romeo Dealership as soon as possible.</p> <p>Alarm system failure</p> <p>This symbol appears to report an alarm system failure. Contact an Alfa Romeo Dealership as soon as possible.</p>
	<p>PARK SENSORS SYSTEM FAILURE</p> <p>The symbol appears to indicate a fault or unavailability of the Park Sensors system.</p> <p>Contact an Alfa Romeo Dealership to have the system checked.</p>
	<p>SPEED LIMITER DEVICE FAILURE</p> <p>While driving, if the symbol switches on, it signals a fault in the Speed Limiter device. Contact an Alfa Romeo Dealership as soon as possible to have the failure eliminated.</p>
	<p>FUEL CUT-OFF SYSTEM OPERATION</p> <p>The symbol appears if the fuel cut-off system intervenes.</p> <p>For the fuel cut-off system re-activation procedure, see the "Fuel cut-off system" chapter in the "In an emergency" section. If it is not possible to restore the fuel supply, contact an Alfa Romeo Dealership.</p>





Symbol	What it means
	<p>POSSIBLE ICE ON ROAD (where provided)</p> <p>The symbol appears when the outside temperature is below or equal to 37.4°F (3°C). The symbol disappears when the outside temperature is equal to 74.8°F (6°C).</p> <p>WARNING In the event of external temperature sensor failure, the digits that indicate the value are replaced by dashes.</p>
	<p>ENGINE OIL PRESSURE SENSOR FAILURE</p> <p>The symbol appears in the event of engine oil level sensor failure. Contact an Alfa Romeo Dealership as soon as possible to have the failure eliminated.</p>
	<p>ENGINE OIL LEVEL SENSOR FAILURE</p> <p>The symbol appears to signal an engine oil level sensor failure. Contact an Alfa Romeo Dealership as soon as possible to have the failure eliminated.</p>
	<p>RAIN SENSOR FAILURE</p> <p>The symbol appears in the event of a rain sensor failure. Contact an Alfa Romeo Dealership as soon as possible.</p>
	<p>START&STOP EVO SYSTEM FAILURE (where provided)</p> <p>This symbol appears to indicate a Start&Stop Evo system failure. Contact an Alfa Romeo Dealership as soon as possible.</p>
	<p>REAR FOG LIGHT</p> <p>The symbol appears when the rear fog light is activated.</p>
	<p>KEYLESS START SYSTEM FAILURE</p> <p>The symbol appears to indicate a Keyless Start system failure. Contact an Alfa Romeo Dealership as soon as possible.</p>
	<p>FUEL CUT-OFF SYSTEM FAILURE</p> <p>The symbol appears in case of a fuel cut-off system failure. Contact an Alfa Romeo Dealership as soon as possible.</p>
	<p>BRAKE PADS WEAR</p> <p>The symbol appears when the brake pads have reached their wear limit. Contact an Alfa Romeo Dealership as soon as possible.</p> <p>WARNING Always use genuine parts or equivalents because the Integrated Brake System (IBS) system could detect anomalies.</p>





Symbol	What it means
	<p>CARBO-CERAMIC BRAKE (CCB) DISC WEAR (where provided)</p> <p>The symbol appears when the carbon ceramic brake discs (CCB) have reached the limit of wear. Contact an Alfa Romeo Dealership as soon as possible.</p> <p> 34)</p>
	<p>FUEL RESERVE / LIMITED RANGE</p> <p>The symbol appears when a few litres of fuel are left in the tank.</p> <p> 16)</p>
	<p>GLOW PLUG PREHEATING FAILURE (Diesel versions)</p> <p>If the symbol flashes, it indicates a fault in the glow plug preheating system. In this case, contact an Alfa Romeo Dealership as soon as possible.</p>
AFS!	<p>AFS (Adaptive Frontlight System) FAILURE</p> <p>The symbol is displayed to signal the failure of the automatic dipped beam/adaptive headlight system (matrix) and/or the momentary disabling of the camera. If the indication persists, contact an Alfa Romeo Dealership.</p>
	<p>AUTOMATIC MAIN BEAM HEADLIGHTS FAILURE</p> <p>The symbol appears to report a failure of the automatic main beam headlights. Contact an Alfa Romeo Dealership as soon as possible to have the failure eliminated.</p>
	<p>TRANSMISSION FLUID OVERHEATING</p> <p>The symbol appears in the event of automatic transmission overheating, after particularly demanding use. In this case an engine performance limitation is carried out. With engine off or at idle speed, wait until the symbol switches off.</p>
	<p>DUSK SENSOR FAILURE</p> <p>The symbol appears in the event of dusk sensor failure. Contact an Alfa Romeo Dealership as soon as possible.</p>
	<p>BSM (Blind Spot Monitoring) SYSTEM FAILURE</p> <p>The symbol appears in the event of a BSM (Blind Spot Monitoring) system failure. Contact an Alfa Romeo Dealership as soon as possible.</p>





Symbol	What it means
 (left-hand drive versions)	SHOCK ABSORBER FAILURE (ADC) (where provided) The symbol appears while driving to indicate a fault in the suspension system. Contact an Alfa Romeo Dealership to have the system checked.
 (right-hand drive versions)	
 (left-hand drive versions)	SUSPENSION CALIBRATION ADJUSTMENT (where provided) With "Race" mode active, the car suspension is set to "Stiff" by default. Pressing the  button returns the suspension to "Automatic" mode: the symbol appears on the instrument panel display to indicate that this mode has been activated.
 (right-hand drive versions)	
 (left-hand drive versions)	SOFT SUSPENSION CALIBRATION INSERTION (where provided) The system appears when the most comfortable suspension setting is activated.
 (right-hand drive versions)	
	DIPPED BEAM AUTOMATIC ADJUSTMENT FAILURE The symbol appears in the case of failure of the automatic dipped beam headlights alignment. Contact an Alfa Romeo Dealership as soon as possible.
	WATER IN DIESEL FILTER (Diesel versions) The symbol appears constantly while driving, along to indicate the presence of water in the diesel filter.  17)
	LPG FUEL LEVEL SENSOR FAILURE (where provided) The symbol appears in the event of fuel level sensor failure. Contact an Alfa Romeo Dealership as soon as possible.











Symbol	What it means
	<p>DEGRADED ENGINE OIL (where provided)</p> <p>Diesel versions: the symbol is shown on the display. The symbol is displayed for 3 minute cycles and intervals of 5 seconds until oil is changed. The symbol is displayed until the problem is solved.</p> <p>Petrol versions: the symbol appears and then is not displayed when the display cycle is completed.</p> <p>WARNING After the first indication, each time the engine is started the symbol will continue to switch on as described above until the oil is changed.</p> <p>If the symbol flashes, this does not mean that there is a fault on the car, rather it simply reports that it is now necessary to change the oil as a result of regular use of the car. The deterioration of engine oil is accelerated by using the car for short drives, preventing the engine from reaching operating temperature. Contact an Alfa Romeo Dealership as soon as possible.</p> <p> 18) 16)</p>
	<p>FUEL FILLER CAP NOT CLOSED (where provided)</p> <p>The symbol appears if the fuel tank cap is open or not properly closed. Tighten the cap properly.</p>
	<p>EXTERNAL LIGHTS FAILURE</p> <p>The symbol appears to indicate a failure in the following lights: daytime running lights (DRLs) / parking lights / side lights / trailer direction indicators (where provided) / trailer lights (where provided) / direction indicators / rear fog light / reversing light / brake lights / LED headlights.</p> <p>The anomaly may be caused by a blown bulb, a blown protection fuse or an interruption of the electrical connection. In this case, contact an Alfa Romeo Dealership.</p>
	<p>ACC (Active Cruise Control) FAILURE (where provided)</p> <p>The symbol appears to signal a fault in the ACC (Active Cruise Control) system. In this case, contact an Alfa Romeo Dealership as soon as possible.</p>



Symbol	What it means
	<p>DPF (Diesel Particulate Filter) CLEANING in progress (Diesel versions with DPF only)</p> <p>The symbol appears constantly to indicate that the DPF system needs to eliminate the trapped pollutants (particulate) through the regeneration process. The symbol stays off during the entire DPF regeneration and appears only when driving conditions require the driver to be notified.</p> <p>The symbol does not appear during every DPF regeneration, but only when driving conditions require that the driver is notified. To turn off the symbol, keep the car in motion until the regeneration process is over. The process normally takes about 15 minutes. Optimal conditions for completing the process are achieved by travelling at 37 mph (60 km/h) with engine speed above 2000 rpm.</p> <p>When this symbol switches on, it does not indicate a defect of the car and thus it should not be taken to a workshop.</p> <p>WARNING Failure to follow the procedure provided for when the symbol comes on for a mileage equal to or greater than 18 miles (30 km) or for a cumulative time equal to or greater than 2 hours, may result in the warning light coming on with consequent damage to the DPF device. Remember that if the warning light is on, it is necessary to go to the Alfa Romeo Dealership to restore the correct function of the DPF.</p> <p> 19)</p>
	<p>GPF (Gasoline Particulate Filter) CLEANING in progress (petrol versions only with GPF) (where provided)</p> <p>The symbol appears constantly to indicate that the GPF system needs to eliminate the trapped pollutants (particulate) through the regeneration process.</p> <p>The symbol does not appear during every GPF regeneration, but only when driving conditions require that the driver is notified.</p> <p>To turn off the symbol, keep the car in motion until the regeneration process is over. The optimal conditions for completing the process are achieved by varying the speed of the car (press and release the accelerator pedal). Hold a speed faster than 37 mph (60 km/h), on extra-urban roads, with the engine running faster than 2000 rpm, until the symbol and the message disappear from the display.</p> <p>When this symbol switches on, it does not indicate a fault and thus it should not be taken to a workshop.</p> <hr/> <p>GPF (Gasoline Particulate Filter) FAILURE (petrol versions only with GPF) (where provided)</p> <p>The symbol lights up fixed, together with the warning light in case of failure of the GPF (Gasoline Particulate Filter). In this case, contact an Alfa Romeo Dealership as soon as possible.</p>



Symbol	What it means
	<p>LOW AdBlue® (UREA) DIESEL EMISSIONS ADDITIVE LEVEL WARNING (diesel versions only)</p> <p>The AdBlue® Diesel Emissions Additive (UREA) low level symbol appears when the AdBlue® (UREA) level is low. A warning and a message indicating the need to top up AdBlue® (UREA) also appear on the display. The symbol stays on until the tank is topped up with at least 1.11 UK gal (5 litres) of AdBlue® (UREA). A message will appear permanently on the instrument panel and an acoustic tone will be heard when there is about 125 miles (200 km) of range left. A specific message will appear on the instrument panel display when there are 0 miles (0 km) of range left. It will no longer be possible to restart the engine after it has been stopped. It will be possible to restart the engine after pouring at least 1.11 UK gal (5 litres) of AdBlue® (UREA) into the tank. Top up the AdBlue® (UREA) tank as soon as possible with at least 1.11 UK gal (5 litres) of AdBlue® (UREA). If the top-up was done with a range of 0 mi (0 km) left in the AdBlue® (UREA) tank equal to 0 mi (0 km), you may need to wait 2 minutes before starting the engine. If you do not top up, a dedicated message will appear on the instrument panel display whenever a certain threshold is reached until it will no longer be possible to start the engine.</p>
	<p>BRAKE PEDAL (where provided)</p> <p>This symbol turns on to indicate that the brake pedal must be pressed to enable reversing.</p>
ABS ACTIVE	<p>ABS (Anti-lock Braking System) ACTIVATION</p> <p>The symbol appears if the ABS system intervenes.</p>
	<p>LOW WINDSCREEN WASHING FLUID LEVEL</p> <p>The symbol appears for some seconds to indicate that the level of the windscreen washing fluid is low. Refill the liquid: to do this, see the "Checking levels" chapter in the "Maintenance and care" section. Always use liquid with the features indicated in the "Fluids and lubricants" chapter in the "Technical specifications" section.</p>
	<p>WINDSCREEN WIPER FAILURE</p> <p>The symbol appears to indicate a windscreen wiper failure. Contact an Alfa Romeo Dealership as soon as possible to have the failure eliminated.</p>
	<p>HAS (Highway Assist) SYSTEM / TJA (Traffic Jam Assist) SYSTEM FAILURE</p> <p>The symbol appears in case of HAS (Highway Assist) or TJA (Traffic Jam Assist) system failure. Contact an Alfa Romeo Dealership as soon as possible to have the failure eliminated.</p>

Symbol	What it means
	LDW (Lane Departure Warning) FAILURE The symbol appears in the event of a failure in the LDW (Lane Departure Warning system). Contact an Alfa Romeo Dealership as soon as possible.
	LKA (Lane Keeping Assist) SYSTEM FAILURE The symbol appears in the event of a failure in the LKA (Lane Keeping Assist system). Contact an Alfa Romeo Dealership as soon as possible.
	DAA (Driver Attention Assist) SYSTEM FAILURE (where provided) The symbol appears in the event of a DAA (Driver Attention Assist) system failure. Contact an Alfa Romeo Dealership as soon as possible to have the failure eliminated.
	ELECTRIC TOW HOOK FAILURE The symbol appears to indicate an electric towing hook extraction/closing system failure. Contact an Alfa Romeo Dealership as soon as possible to have the failure eliminated.
	TRAILER LIGHT CONTROL UNIT FAILURE The symbol appears to warn of failure in the control unit that manages the trailer lights. Check that the trailer light is correctly connected to the socket. If the fault persists the next time you start the engine, contact the Alfa Romeo Dealership as soon as possible to have the system checked.
	GENERIC FAILURE If this symbol appears to indicates information and failures. The accompanying messages on the display describe the fault. Contact an Alfa Romeo Dealership as soon as possible to have the failure eliminated.
	DYNAMIC TRACTION CONTROL SYSTEM FAILURE This symbol appears to indicate a dynamic traction control system failure. Contact an Alfa Romeo Dealership as soon as possible to have the failure eliminated.
	ALL-WHEEL DRIVE FAILURE This symbol appears to report an all-wheel drive system failure. Contact an Alfa Romeo Dealership as soon as possible to have the failure eliminated.



Symbol	What it means
	<p>TEMPORARY ALL-WHEEL DRIVE FAILURE (where provided)</p> <p>The symbol appears to indicate that the AWD dynamic traction control system is temporarily deactivated to prevent damage because of high engine load. The traction system will work in RWD mode in this case.</p> <p>Until the symbol appears on the display, reduce the load to allow the system to cool down. The AWD system will resume normal operation when the symbol disappears from the display.</p>
	<p>TAILGATE ELECTRIC OPENING/CLOSING FAILURE</p> <p>The symbol appears to indicate a tailgate electric opening/closing system failure. Contact an Alfa Romeo Dealership as soon as possible to have the failure eliminated.</p>

**WARNING**

34) It is recommended to use only original or equivalent, bench-tested spare pads in order to ensure the original performance of the braking system.

**IMPORTANT**









16) If the warning light (or the icon on the display) flashes while driving, contact an Alfa Romeo Dealership.

17) The presence of water in the fuel system circuit may cause severe damage to the injection system and irregular engine operation. If the  symbol is displayed (along with a message in the display) contact a Alfa Romeo Dealership as soon as possible to bleed the system. If the above indications come on immediately after refuelling, water has probably been introduced into the tank: turn the engine off immediately and contact an Alfa Romeo Dealership.

18) Degraded engine oil should be replaced as soon as possible after the warning light  comes on, and never more than 500 km after it first comes on. Failure to observe the above may result in severe damage to the engine and invalidate the warranty. **Remember that when this warning light comes on, it does not mean that the level of engine oil is low, so if it flashes it does not mean that you need to top up the engine oil.**

19) Vehicle travel speed should always be adapted to the traffic and weather conditions, and must always comply with traffic regulations. The engine can be stopped even if the DPF warning light is on: however, repeated interruptions of the regeneration process could cause premature deterioration of the engine oil. For this reason it is always advisable to wait for the symbol to go off before turning off the engine, following the instructions above. Do not complete the DPF regeneration process when the vehicle is stopped.



Green Symbols

Symbol	What it means
	<p>SIDE LIGHTS</p> <p>The symbol appears when the side lights are activated.</p> <p>"Follow me" function engaged</p> <p>This function allows the headlights to remain on for 30, 60 or 90 seconds after the ignition device was placed in STOP position ("Follow me").</p>
	<p>AUTOMATIC DIPPED BEAM HEADLIGHTS</p> <p>The symbol appears when the automatic dipped beam headlights are activated.</p>
	<p>DIPPED BEAM HEADLIGHTS</p> <p>The symbol appears when the dipped beam headlights are activated.</p>
	<p>START&STOP EVO SYSTEM INTERVENTION (where provided)</p> <p>The symbol appears in the case of Start&Stop Evo system (engine off) intervention. Restarting the engine, the warning light switches off.</p>
	<p>CRUISE CONTROL ACTIVATION</p> <p>The symbol is displayed the Cruise Control device is activated.</p>
	<p>ACTIVE CRUISE CONTROL (ACC) ACTIVATION</p> <p>The symbol is displayed the Active Cruise Control device is activated.</p>
	<p>SPEED LIMITER ACTIVATION</p> <p>The symbol appears when the Speed Limiter device is activated.</p>
	<p>HDC (Hill Descent Control) SYSTEM</p> <p>The symbol appears if the HDC (Hill Descent Control) system intervenes.</p>





ABC

Blue symbols





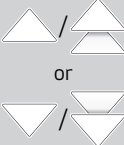



Symbol	What it means
	AUTOMATIC HIGH BEAM HEADLIGHTS The symbol appears when the automatic main beam headlights are activated.
	MAIN BEAM HEADLIGHTS The symbol appears when the main beam headlights are activated.

White symbols





Symbol	What it means
	AUTOMATIC DIPPED BEAM HEADLIGHTS LIT The symbol appears when the main beam headlights are activated.
	AUTOMATIC DIM HIGH BEAMS LIT The symbol appears when the automatic main beam headlights are activated.
	HDC (Hill Descent Control) SYSTEM ENABLING The symbol is displayed to indicate that HDC (Hill Descent Control) is enabled.
	GEAR SHIFT INDICATOR (where provided) The symbols appear on the display to alert the driver to the need to shift up or down. The single arrow indicates to shift up or down one gear, the double arrow to shift two gears.

Lane Keeping Assist symbols

Display	Miniature	Description
		Sensor not available







Display	Miniature	Description
		Active system
		System active: only one sideline detected NOTE The symbol shown is an example: the detected side line is displayed white and the undetected one is grey.
		Car close to the side line NOTE The symbol shown is an example: the side line the car is approaching is displayed yellow and the other is white (if detected) or grey (if not detected).
		The car crossed the side line. NOTE The symbol shown is an example: the side line the car is approaching is displayed in flashing yellow and red and the other in white (if detected) or grey (if not detected).

Lane Departure Warning symbols

Miniature	Description
	Sensor not available or Car travelling under the set speed limit or side line not detected by the front camera.
	System active: both side lines detected
	System active: only one sideline detected NOTE The symbol shown is an example: the detected side line is displayed white and the undetected one is grey.
	Car close to the side line NOTE The symbol shown is an example: the side line the car is approaching is displayed yellow and the other is white (if detected) or grey (if not detected). The yellow line will flash on the display.
	The car crossed the side line. NOTE The symbol shown is an example: the side line the car is approaching is displayed in flashing yellow and red and the other in white (if detected) or grey (if not detected).



Highway Assist symbols

Miniature	Description
	System ready: side line not detected
	System ready: both side lines detected
	System active: both side lines detected
	System active: both side lines detected and driver's hands removed briefly from the steering wheel
	System active: both side lines detected and driver's hands removed from the steering wheel for a long time
	System active: side line not detected and driver's hands removed from the steering wheel
	System active: side line crossed (displayed flashing yellow) NOTE The symbol shown is an example: the crossed sideline is displayed yellow and the other one is green

EOBD SYSTEM (European On Board Diagnosis)

(where provided)

OPERATION

The EOBD (European On Board Diagnosis system) carries out a continuous diagnosis of the components of the car related to emissions.

It also turns on the  warning light on the instrument panel to alert the driver when these components are no longer in peak condition (see the “Warning lights and messages” chapter in this section).

The aim of the EOBD system (European On Board Diagnosis) is to:

- monitor system efficiency;
- indicate an increase in emissions;
- indicate the need to replace damaged components.

The car also has a connector, which can interface with appropriate tools, that makes it possible to read the error codes stored in the electronic control units together with a series of specific parameters for engine operation and diagnosis. This check can also be carried out by the traffic police.

WARNING After eliminating a fault, to check the system completely, the Alfa Romeo Dealership is obliged to run tests and, if necessary, road tests which may also require a long journey.



ABC

Blank page



SAFETY

ACTIVE SAFETY SYSTEMS	94
DRIVING ASSISTANCE SYSTEMS	98
DAA (Driver Attention Assist) SYSTEM	109
OCCUPANT PROTECTION SYSTEMS	111
SEAT BELTS	111
SBA (Seat Belt Alert) SYSTEM	112
PRE-TENSIONERS	114
CHILD RESTRAINT SYSTEMS	115
SUPPLEMENTARY RESTRAINT SYSTEM (SRS)- AIRBAG	129

The following section is very important: it describes the safety systems fitted on the car and provides the necessary information on how to use them correctly.

ACTIVE SAFETY SYSTEMS

The car may be equipped with the following active safety devices:

- ABS (Anti-Lock Brakes);
- DTC (Drive Train Control);
- ESC (Electronic Stability Control);
- TC (Traction Control);
- PBA (Panic Brake Assist);
- HSA (Hill Start Assist);
- AST (Alfa™ Steering Torque);
- HDC (Hill Discent Control).

For the operation of the systems, see the following pages.

ABS (Anti-lock Braking System)

This system, which is an integral part of the braking system, prevents one or more wheels from locking and slipping in all road surface conditions, irrespective of the intensity of the braking action, ensuring that the car can be controlled even during emergency braking and optimising stopping distances.

The system intervenes during braking when the wheels are about to lock, typically in emergency braking or low-grip conditions, when locking may be more frequent.

The system also improves control and stability of the car when braking on a surface where the grip of the left and right wheels varies, or on corners.

The Electronic Braking Force Distribution (EBD) system completes the system allowing the brake force to be distributed between the front and rear wheels.

System intervention

The ABS equipped on this car is provided with the "Brake by wire" (Integrated Brake System - IBS) function. With this system, the brake pedal command given by pressing the brake pedal is not transmitted hydraulically but electronically, therefore, the light pulsation that could be felt on the pedal with the traditional system is no longer perceptible.

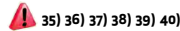

DTC (Drive Train Control) SYSTEM (where provided)

Some versions of this car are equipped with an all-wheel drive system (AWD), activated on request, which offers an optimal drive for countless driving conditions and road surfaces. The system reduces the slipping of the tyres to a minimum, automatically redistributing the torque to the front and rear wheels, as needed.

To maximise fuel savings, the car with AWD automatically passes to rear-wheel drive (RWD) when the road and environmental conditions are such that they would not cause the tyres to slip.

When the road and environmental conditions require better traction, the car automatically goes to AWD mode.



WARNING If the system failure symbol switches on, after starting the engine or while driving, it means that the AWD system is not working properly. If the warning message activates frequently, it is recommended to carry out maintenance operations.



ESC SYSTEM (Electronic Stability Control)

The ESC system improves the directional control and stability of the car in various driving conditions.

The ESC system corrects the car's understeer and oversteer, distributing the brake force on the appropriate wheels. The torque supplied by the engine can also be reduced in order to maintain control of the car.

The ESC system uses sensors installed on the car to determine the trajectory that the driver intends to follow and compares it with the car's effective trajectory. When the real trajectory deviates from the desired trajectory, the ESC system intervenes to counter the car's understeer or oversteer.

□ **Oversteer:** occurs when the car is turning more than it should according to the angle of the steering wheel.

□ **Understeer:** occurs when the car is turning less than it should according to the angle of the steering wheel.

System intervention

The intervention of the system is indicated by the flashing of the ESC warning light on the instrument panel, to inform the driver that the car stability and grip are critical.

 43) 44) 45) 46) 47)

Deactivating the system

The ESC system deactivates automatically when using RACE driving mode (where provided).

TC (Traction Control) SYSTEM

The system automatically operates in the event of slipping, loss of grip on wet roads (aquaplaning) and acceleration on slippery, snowy or icy roads, etc. on one or both drive wheels. Depending on the slipping conditions, two different control systems are activated:

□ *if the slipping involves both drive wheels*, the system intervenes, reducing the power transmitted by the engine;

□ *if the slipping only involves one of the drive wheels*, the BLD (Brake Limited Differential) function is activated, automatically braking the wheel which is

slipping (the behaviour of a self-locking differential is simulated). This will increase the drive torque transferred to the wheel that is not slipping.

System intervention

The intervention of the system is indicated by the flashing of the ESC warning light on the instrument panel, to inform the driver that the car stability and grip are critical.

 48) 49) 50) 51) 52)

PBA (Panic Brake Assist) SYSTEM

The PBA system is designed to improve the car's braking capacity during emergency braking.

The system detects emergency braking by monitoring the speed and force with which the brake pedal is pressed, and consequently applies the optimal brake pressure. This can reduce the braking distance: the PBA system therefore complements the ABS.

Maximum assistance from the PBA system is obtained by pressing the brake pedal very quickly. In addition, the brake pedal should be pressed continuously during braking, avoiding intermittent presses, to get the most out of the system. Do not reduce pressure on the brake pedal until braking is no longer necessary.

The PBA system is deactivated when the brake pedal is released.

 53) 54) 55)

HSA (Hill Start Assist) SYSTEM

This is an integral part of the ESC system and facilitates starting on slopes, activating automatically in the following cases:

□ *uphill:* car stationary on a road with a gradient higher than 5%, engine running, brake pressed and transmission in neutral or gear other than reverse engaged;

□ *downhill:* car stationary on a road with a gradient higher than 5%, engine running, brake pressed and reverse gear engaged.

When setting off, the ESC system control unit maintains the braking pressure on the wheels until the drive torque necessary for starting is reached, or in any case for a maximum of 2 seconds, allowing your right foot to be moved easily from the brake pedal to the accelerator.

When the 2 seconds have elapsed, without starting, the system is automatically deactivated, gradually releasing the braking pressure.

During this release stage, the typical mechanical brake release noise can be heard, indicating that the car is about to move.



ABC



56) 57)

AST (Alfa™ Steering Torque) SYSTEM



58)

The AST function integrates the ESC system with the electric power steering to increase the safety level of the whole car.

In critical situations (braking on surfaces with different grip conditions), through the AST function, the ESC system controls the steering to implement an additional torque contribution on the steering wheel, to suggest the most correct manoeuvre to the driver.

The coordinated action of the brakes and steering increases the sensation of safety and control of the car.

HDC (Hill Descent Control) SYSTEM

(where provided)

On cars equipped in this way, this function is an integral part of the ESC system and is aimed at keeping the car at a constant speed during a descent, operating autonomously and in different ways on the brakes.

In this way the vehicle stability and completely safe driving are guaranteed, above all in poor grip conditions and steep descents.

The system has three different modes:

- Off:** the system is deactivated;
- Enabled:** the system is enabled and ready to intervene when the activation conditions are met;
- Active:** the system actively controls the car speed.

Enabling the system

To enable the system, press the button fig. 105.



105

07146V0021EM

The system is enabled if the car speed is below 20 mph (30 km/h). The system stays enabled until the car speed reaches 37 mph (60 km/h): the system is disabled at faster speed.

System activation is indicated by the white  icon on the display fig. 106 turning on fixed.

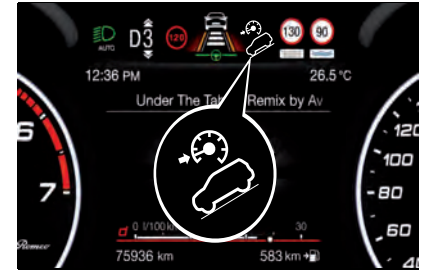

106

0503650184EM

System Activation

Once enabled, the HDC system will activate automatically if the car is driven downhill on a steep slope, higher than 8%.

The speed set for the HDC system can be adjusted using the SET stalk fig. 107 (in the range from 1.25 mph to 20 mph (from 2 km/h to 30 km/h).

Once the desired speed has been reached, release the SET stalk and the HDC system will maintain the set speed.

It is also possible to reduce the set speed with the brake pedal. The system will acquire the current speed when the pedal is released as the reference.



107

07146V0022EM

If the car speed exceeds 6 mph (10 km/h), but remains below 37 mph (60 km/h) and the accelerator pedal is released, as soon as the car gets close to the set speed, the HDC system will brake to bring the car to the set speed.

The driver can cancel HDC system intervention at any time by pressing the accelerator pedal.

Deactivating the system

The HDC system is deactivated, but remains available, if one of the following conditions is met:

- ❑ the car is on a descent with insufficient gradient, below 8%, or a level surface, or is going uphill;
- ❑ P (Park) mode is engaged.

Disabling the system



59)

The system is disabled if one of the following conditions is met:

- ❑ button fig. 105 pressed;
- ❑ Cruise Control / Active Cruise Control is activated.
- ❑ 37 mph (60 km/h) is exceeded.

System deactivation is shown by the icon  on the display turning off.



WARNING

35) For maximum efficiency of the braking system, a bedding-in period of about 500 km (310 miles) is required: during this period it is advisable to avoid sharp, repeated and prolonged braking.

36) If the ABS intervenes, this indicates that the grip of the tyres on the road is nearing its limit: you must slow down to a speed compatible with the available grip.

37) The ABS cannot overrule the natural laws of physics, and cannot increase the grip available according to the condition of the road.

38) The ABS cannot prevent accidents, including those due to excessive speed on corners, driving on low-grip surfaces or aquaplaning.

39) The capability of the ABS must never be tested irresponsibly and dangerously, in such a way as to compromise personal safety and the safety of others.

40) For the correct operation of the ABS, the tyres must of necessity be the same make and type on all wheels, in perfect condition and, above all, of the prescribed type and dimensions.

41) There may be a brief delay in shifting to AWD mode after a tyre slipping event.

42) When a DTC system failure symbol appears, the driver must be aware of the different driving reaction and therefore reduce the speed. The symbol  warns the driver not to drive in areas that require four-wheel drive or on snow-covered roads.

43) The ESC system cannot alter the natural laws of physics, and cannot increase grip, which depends on the condition of the road.

44) The ESC system cannot prevent accidents, including those due to excessive speed on corners, driving on low-grip surfaces or aquaplaning.

45) The capability of the ESC system must never be tested irresponsibly and dangerously, in such a way as to compromise personal safety and the safety of others.

46) For the correct operation of the ESC system, the tyres must necessarily be of the same make and type on all wheels, in perfect condition and, above all, of the prescribed type and size.

47) ESC performance features must not induce the driver to take unnecessary or unwarranted risks. Your driving style must always be suited to the road conditions, visibility and traffic. The driver is, in any case, responsible for safe driving.

48) For the correct operation of the TC system, the tyres must of necessity be the same make and type on all wheels, in perfect condition and, above all, of the prescribed type and dimensions.

49) TC performance features must not induce the driver to take unnecessary or



ABC

unwarranted risks. Your driving style must always be suited to the road conditions, visibility and traffic. The driver is, in any case, responsible for safe driving.

50) The TC system cannot overrule the natural laws of physics, and cannot increase the grip available according to the condition of the road.

51) The TC system cannot prevent accidents, including those due to excessive speed on corners, driving on low-grip surfaces or aquaplaning.

52) The capability of the TC system must never be tested irresponsibly and dangerously, in such a way as to compromise personal safety and the safety of others.

53) The PBA system cannot overrule the natural laws of physics, and cannot increase the grip available according to the condition of the road.

54) The PBA system cannot prevent accidents, including those due to excessive speed on corners, driving on low-grip surfaces or aquaplaning.

55) The capability of the PBA system must never be tested irresponsibly and dangerously, in such a way as to compromise the safety of the driver, the other occupants of the car or any other road user.

56) The HSA system is not a parking brake; therefore, never leave the car without having engaged the electric parking brake, turned the engine off and engaged first gear, so that it is parked in safe conditions (for further information, see the "Parking" chapter in the "Starting and driving" section).

57) There may be situations on small gradients (less than 8%), with vehicle laden, in which the Hill Start Assist system may not activate, causing a slight reversing motion and increasing the risk of collision with another vehicle or object. The driver is, in any case, responsible for safe driving.

58) The AST system is an aid for driving and does not relieve the driver of responsibility for driving the car.

59) The performance of a car with HDC must never be tested in imprudent or dangerous ways, with the possibility of putting the safety of the driver or other people at risk.

DRIVING ASSISTANCE SYSTEMS

The car can feature the following driving assistance systems:

- BSM (Blind Spot Monitoring)
- ABSA (Active Blind Spot Assist)
- FCW (Forward Collision Warning)
- TPMS (Tyre Pressure Monitoring System)
- DAA (Driver Attention Assist)

For the operation of the BSM / ABSA / FCW / TPMS / DAA systems, see the following pages.

The car may also be fitted with the following driving assistance systems:

- LDW (Lane Departure Warning)

- LKA (Lane Keeping Assist)
- HAS (Highway Assist)
- TJA (Traffic Jam Assist)
- ACC (Active Cruise Control)
- ISC (Intelligent Speed Control)
- TSR (Traffic Sign Recognition)

For the operation of the LDW / LKA / HAS / TJA / ACC / ISC / TSR systems, see the "Starting and driving" section.



60) 61)

BSM (Blind Spot Monitoring) SYSTEM (where provided)

The BSM (Blind Spot Monitoring) system uses two radar sensors, located in the rear bumper (one for each side - see fig. 108), to detect the presence of cars (cars, trucks, motorbikes, etc.) in the rear side blind spots of your car.

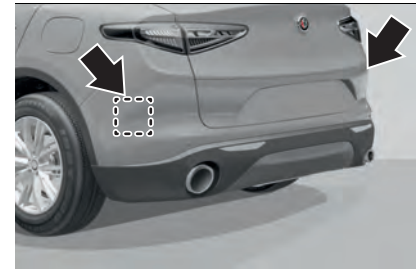

108

9490107

The system warns the driver about the presence of vehicles in the detection area by lighting up, on the relevant side, the warning light located on the door

mirror fig. 109 and, where provided, by means of an acoustic warning (if the respective item is programmed on the Connect system).

The default setting is "Sound and Display".



109

9490117

When the engine is started the warning light turns on to signal the driver that the system is active.

Activation / deactivation

The system can be activated/deactivated using the "Driver Assistance" menu and then selecting "Safety" on the Connect system.

Sensors



62)

The sensors are activated when any forward gear is engaged at a speed equal to or higher than 10 km/h, or when reverse gear is engaged.

The sensors are temporarily deactivated when the car is stationary and the P (Park) mode active.

The detection area of the system covers about a lane on both sides of the car (around 10 ft / 3 metres).

This area begins from the door mirror and extends for about 20 ft (6 metres) towards the rear part of the car.

When the sensors are active the system monitors the detection areas on both sides of the car and warns the driver about the possible presence of cars in these areas.

While driving, the system monitors the detection area in three different situations:

- when you are being overtaken by a vehicle;
- when you are overtaking a vehicle;
- when a vehicle approaches from the side;

to check whether it is necessary to send a signal to the driver on both sides.

Warnings

The system does not signal the presence of fixed object (e.g. safety barriers, poles, walls, etc.). However, in some circumstances, the system may activate in the presence of these objects. This behaviour is normal and does not indicate a system malfunction.

The system does not warn the driver about the presence of cars coming from the opposite direction, in the adjacent lanes.

If a trailer is hitched to the car, the system automatically deactivates.

For the system to operate correctly, the rear bumper area where the radar sensors are located must stay free from snow, ice and dirt gathered from the road surface.

Do not cover the rear bumper area where the radar sensors are located with any object (e.g. adhesives, bike rack, etc.).

If, after purchasing the vehicle, you wish to install the tow hook, you need to deactivate the system via the Connect system. To access the function, on the main menu select the following items in sequence: "Settings", "Safety" and "Blind Spot Alert".

Rear view

The system detects vehicles approaching from the rear of the car on both sides and entering the rear detection area with a difference in speed of less than approximately 25 mph (40 km/h) with respect to your car.

Overtaking vehicles

If another vehicle is overtaken slowly (with a difference in speed of less than about 15.5 mph / 25 km/h) and this stays in the blind spot for about 1.5 seconds,



ABC

the warning light on the door mirror of the corresponding side lights up.

If the difference in speed between the two vehicles is greater than about 15.5 mph (25 km/h), the warning light does not light up.

RCP (Rear Cross Path detection)

This function helps the driver during reverse manoeuvres in the case of reduced visibility.

The RCP function the rear detection areas on both sides of the car, to detect objects moving towards the sides of the car at a minimum speed between about 0.6 mph (1 km/h) and 2 mph (3 km/h) and objects moving at a maximum speed of 22 mph (35 km/h), as generally happens in parking areas.

The function activation is signalled to the driver by a visual and acoustic warning.

WARNING If the sensors are covered by obstacles or cars, the system will not warn the driver.

Operating Mode

The system may be activated/deactivated via the Connect system. On the main menu select the following items in sequence: "Settings", "Safety" and "Blind Spot Alert".

"Blind Spot Alert", "Visual" mode

When the system is enabled and presence of a vehicle in the blind spot is

detected, a visual warning is sent to the concerned door mirror on the side of the detected object.

The visual warning on the mirror will blink if the driver switches on the direction indicators to indicate the intention to change lane in the direction of the detected object.

The warning will be fixed if the driver stays on the same lane.

"Blind Spot Alert" function deactivation

When the function is deactivated ("Blind Spot Alert" mode at "OFF"), the BSM or RCP systems will not emit neither acoustic nor visual warnings.

The BSM system will store the operating mode running when the engine was switched off. Each time the car is started the previously stored mode will be recalled and used.

ABSA (Active Blind Spot Assist) SYSTEM

(where provided)

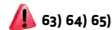

It is a driving assistance system able to avoid/limit lateral collisions with cars coming from adjacent lanes by changing the trajectory of the vehicle with the aim of keeping it in the detected lane.

If the direction indicator on the corresponding side is switched on, the

system alerts you of the presence of vehicles in the detection area by flashing the light on the door mirror fig. 110 on the corresponding side. Acoustic warnings and/or steering wheel vibrations and/or counter-steering torque on the steering wheel may be applied according to the corresponding settings set in the "Driver Assistance" menu on the Connect system.

When the engine is started, the warning light turns on to indicate to the driver that the system is active (the warning light comes on if the system is activated through the Connect system menu).



110

9490117

Sensors

The system uses two radar sensors, located in the rear bumper (one for each side - see fig. 111) to detect the presence of vehicles (cars, trucks, motorbikes, etc.) in the rear side blind spots of the car.

The sensors are activated when any forward gear is engaged at a speed equal to or higher than 6 mph (10 km/h), or when reverse gear is engaged.

The sensors are temporarily deactivated when the car is stationary and the P (Park) mode active.

The detection area of the system covers about a lane on both sides of the car (around 10 ft / 3 metres). This area begins from the door mirror and extends for about 20 ft (6 metres) towards the rear part of the car.

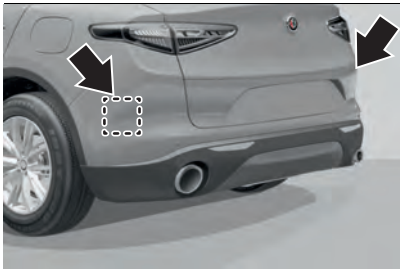

111

9490107

While driving, the system monitors the detection area in three different situations:

- when you are being overtaken by a vehicle;
- when you are overtaking a vehicle;
- when a vehicle approaches from the side;

to check if it is necessary to intervene in order to keep the vehicle inside the lane on both sides.

Activation / deactivation

The system can be activated/deactivated by using the "Driver Assistance" menu on the Connect system selecting signal type, strength levels and sensitivity.

System intervention

The system intervenes in the following conditions:

- the direction indicators have been turned on;
- there is a vehicle in the adjacent lane on the same side of the direction indicator (blind spot area);
- lane lines are correctly detected;
- the driver tries to change lane intentionally.

If the system detects the presence of a vehicle in the other lane, it applies a torque on the steering wheel (if it has been set through the "Settings" menu of the Connect system), in order to warn the driver of the need to keep the car inside the lane and thus avoid collisions with other vehicles.

The application of torque is however only available with a car speed from 40 mph to 110 mph (60 km/h to 180 km/h).

The visual, auditory and vibration indications are only available with a car speed from 6 mph to 110 mph (10 km/h to 180 km/h).

The application of torque, as well as of the vibration, is suppressed/inhibited if:

- the torque given by the driver to the steering wheel is high;
- lateral acceleration is high;
- the trailer is connected to the correct control module;
- at least one hand is not detected on the steering wheel for longer than a specific time.

System availability

Particularly sporty driving of the car, or driving on the marking line, will prevent the system from operating correctly.

When the stability and braking systems (FCW, ESC, ABS) intervene, they prevent the ABSA system from operating.

Changing lanes without activating the direction indicator disables the system for a certain period of time.

The road must also comply with some characteristics, such as maximum-minimum width, it must be provided with a lane clearly delimited by two marker lines and, only in specific cases and for a limited period of time, by lane with single marker line.



ABC

NOTE "Lane lines demarcations" mean the limits with painted lines.

Hands presence on the steering wheel detection

The system is able to detect the presence of the driver's hands on the steering wheel.

- if the driver has not yet returned his or her hands to the steering wheel for a few seconds, a dedicated screen will appear on the instrument panel. No acoustic warning will be emitted in this case;
- when the system does not detect the presence of hands on the steering wheel for a few seconds, a dedicated screen will appear on the instrument panel display. A short acoustic warning will sound in this case;
- if the driver continues not to return his or her hands to the steering wheel, this screen fig. 112 will appear on the instrument panel display. A continuous acoustic warning will sound in this case.



112

9550218

Warnings

The system does not signal the presence of fixed object (e.g. safety barriers, poles, walls, etc.). However, in some circumstances, the system may activate in the presence of these objects. This behaviour is normal and does not indicate a system malfunction.

The system does not warn the driver about the presence of cars coming from the opposite direction, in the adjacent lanes.

The steering wheel torque is not applied if the system is unable to detect a lane or the direction indicator for the appropriate side has not been switched on.

Hands on the steering wheel are detected by a capacitive sensor installed in it.

RCP (Rear Cross Path detection)

This function helps the driver during reverse manoeuvres in the case of reduced visibility.

The RCP function the rear detection areas on both sides of the car, to detect objects moving towards the sides of the car at a minimum speed between about 0.6 mph (1 km/h) and 2 mph (3 km/h) and objects moving at a maximum speed of 22 mph (35 km/h), as generally happens in parking areas.

The function activation is signalled to the driver by a visual and acoustic warning. WARNING If the sensors are covered by obstacles or cars, the system will not warn the driver.

Changing the system sensitivity

Acting on the "Settings" menu of the Connect system it is also possible to change the sensitivity and the strength of the torque intervention on the steering wheel.

FCW (Forward Collision Warning) SYSTEM

(where provided)

 62) 66) 67) 68) 69) 70) 71) 72) 73)

 20) 21) 22) 23) 24) 25) 26) 27) 28)

This is a driving assistance system which comprises a radar located behind the front bumper fig. 113 and a camera located in the central part of the windscreen fig. 114.

In the event of an imminent collision the system may intervene by braking the car automatically to prevent the crash or reduce its effects.



113

06016V0003EM



114

06016V0004EM

The system provides the driver with acoustic and visual warnings through specific messages on the instrument panel display fig. 115.

The system may intervene automatically in case of imminent collision or impact against a pedestrian crossing the road (speed 31 mph - 50 km/h): the following screen fig. 116 will appear on the instrument panel display.



115

9550245



116

9550246

The acoustic and visual warnings before the system cuts in depend on the car speed. No acoustic/visual warning is generated at speeds slower than 20 mph (30 km/h).

Acoustic/visual warning is generated at speeds faster than 20 mph (30 km/h), instead.

The system may lightly brake to warn the driver if a possible frontal accident is detected (limited braking). Signals and limited braking are intended to allow

the driver to react promptly, in order to prevent or reduce the effects of a potential accident.

In situations with the risk of collision, if the system detects no intervention by the driver, it may provide automatic braking to help slow the vehicle and mitigate the potential frontal collision (automatic braking).

If intervention by the driver on the brake pedal is detected but not deemed sufficient, the system may intervene in order to improve the reaction of the braking system, therefore reducing car speed further (additional assistance in braking stage).

WARNING For safety reasons, when the car has stopped, the brake callipers may remain blocked for about 2 seconds. Press the brake pedal if the car should advance slightly.

Engagement / disengagement

The system may be disengaged (and engaged again) in the "Driver Assistance" menu of the Connect system.

The system can be deactivated even with the ignition device in the ON position.

WARNING The system status can be changed with car at a standstill only.

Activation / deactivation

The Forward Collision Warning system is activated whenever the engine is started



ABC

regardless of the Connect system setting.

After deactivation, the system will not warn the driver about a possible collision with the vehicle ahead, regardless of the setting selected with the Connect system.

WARNING Each time the engine is started, the system is activated regardless of where was when it was previously switched off.

This function is not active at a speed lower than 2.5 mph (4 km/h) or higher than 124 mph (200 km/h).

The system is active:

- each time the engine is started;
- when the ignition device is at ON;
- when it is activated ("ON") on the Connect system;
- when the vehicle speed is between 2.5 and 124 mph (4 and 200 km/h);
- when the front seat belts are correctly fastened.

WARNING If the safety belts of the front seats are not correctly fastened, the system will not intervene on the braking system (only acoustic and visual warnings will be provided).

Changing the system sensitivity

The sensitivity of the system can be changed through the Connect system menu, choosing from one of the following

three options: "Near", "Med" or "Far". See the description in the Connect system supplement for how to change the settings.

The default option is "Med". With this setting, the system warns the driver of a possible collision with the vehicle in front when that vehicle is at a standard distance, between that of the other two settings.

With the system sensitivity set to "Far", the system will warn the driver of a possible collision with the vehicle in front when that vehicle is at a greater distance, thus providing the possibility of acting on the brakes more lightly and gradually.

This setting provides the drivers with the maximum possible reaction time to prevent a potential accident.

With the option set to "Near", the system will warn the driver of a possible accident with the vehicle in front when that vehicle is close. This setting offers the driver a lower reaction time compared to the "Med" and "Far" settings, in the event of a potential collision, but permits more dynamic driving of the vehicle.

The system sensitivity setting is kept in the memory when the engine is switched off.

System limited operation warning

If the dedicated message is displayed, a condition limiting the system operation

may have occurred. The possible reasons of this limitation are something blocking the camera view or a fault.

In this condition it will still be possible to drive the car normally, but automatic braking will not be available in the event of an impending collision.

If an obstruction is signalled, clean the area of the windscreen indicated in fig. 114.

When the conditions limiting the system functions end, this will go back to normal and complete operation. Should the fault persist, contact an Alfa Romeo Dealership.

System Fault Message

If the system switches off and a dedicated message is shown on the display, it means that there is a fault on the system.

In this case, it is still possible to drive the vehicle, but you are advised to contact an Alfa Romeo Dealership as soon as possible.

Radar indication not available

If conditions are such that the radar cannot detect obstacles correctly, the system is deactivated and a dedicated message appears on the display.

This generally occurs in the event of poor visibility, such as when it is snowing or raining heavily.

The system can also be temporarily dimmed due to obstructions such as mud, dirt or ice on the bumper. In such cases, a dedicated message will be shown on the display and the system will be deactivated. This message can sometimes appear in conditions of high reflectivity (e.g. tunnels with reflective tiles or ice or snow).

When the conditions limiting the system functions end, this will go back to normal and complete operation.

In certain particular cases, this dedicated message could be displayed when the radar is not detecting any vehicles or objects within its view range.

If atmospheric conditions are not the real reason behind this message, check if the sensor is dirty.

It could be necessary to clean or remove any obstructions in the area shown in fig. 113.

If the message appears often, even in the absence of atmospheric conditions such as snow, rain, mud or other obstructions, contact an Alfa Romeo Dealership for a sensor alignment check.

In the absence of visible obstructions, cleaning the radar surface, by manually removing the decorative cover trim, could be required. Have this operation performed at an Alfa Romeo Dealership.

WARNING It is recommended that you do not install devices, accessories or aerodynamic attachments in front of the sensor or darken it in any way, as this can compromise the correct functioning of the system.

Frontal collision alarm with active braking

(where provided)

If this function is selected, the brakes are operated to reduce the speed of the car in the event of potential frontal impact.

This function applies an additional braking pressure if the braking pressure applied by the driver does not suffice to prevent potential frontal impact.

The function is active with speed above 2.5 mph (4 km/h).

Driving in special conditions

In certain driving conditions, such as, for example:

- driving close to a bend;
- the vehicle ahead is leaving a roundabout;
- vehicles with small dimensions and/or not aligned in the driving lane;
- lane change by other vehicles;
- vehicles travelling at right angles to the vehicle;

system intervention might be unexpected or delayed. The driver must therefore be very careful, keeping

control of the car to drive in complete safety.

WARNING In particularly complex traffic conditions, the driver can deactivate the system manually through the Connect system.

Driving close to a bend

When entering or leaving a wide bend, the system may detect a car that is in front of you, but that is not driving in the same lane fig. 117. In cases such as these, the system may intervene.

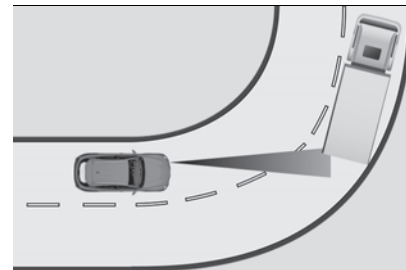

The vehicle ahead is leaving a roundabout

On a roundabout, the system could detect the presence of a vehicle ahead which is leaving the roundabout and cut in fig. 118.



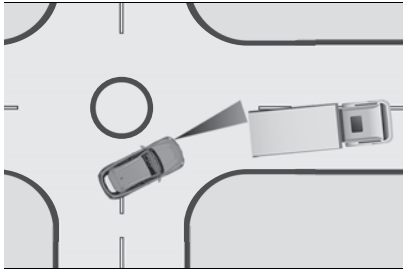

118

06016V0010EM

Vehicles with small dimensions and/or not aligned in the driving lane

The system cannot detect cars in front of you but outside the range of the radar sensor and may therefore not react in the presence of small cars, such as bicycles or motorcycles fig. 119.

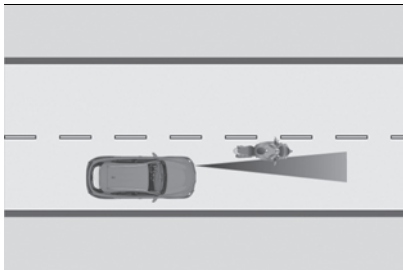

119

06016V0006EM

Lane change by other vehicles

Vehicles suddenly changing lane, entering the same lane as your car and within the radar sensor's operating

range, may cause the system fig. 120 to intervene.

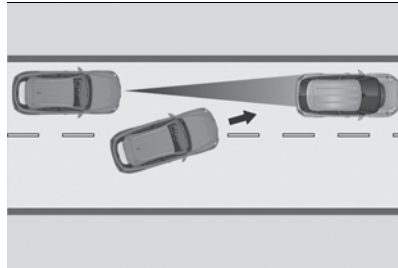

120

06016V0007EM

Vehicles travelling at right angles to the vehicle

The system could temporarily react to a vehicle that is passing through the radar sensor's operating range at right angles fig. 121.

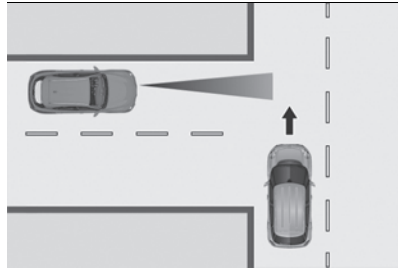

121

06016V0008EM

TPMS (Tyre Pressure Monitoring System)

(where provided)

The car is equipped with Tyre Pressure

⚠️ 74) 75) 76) 77) 78) 79) 80)

⚠️ 29) 30)

Monitoring System (TPMS), which can advise the driver in the event of insufficient tyre pressure according to the cold inflation pressure set by the driver (see indications in the "Technical Specifications" section, "Cold tyre inflation pressure" table).

The system comprises a radio-frequency transmitter sensor fitted to each wheel (on the rim inside the tyre), which is able to send information on the inflation pressure of each tyre to the control module fig. 122.



122

9550168

The inflation pressure varies in relation to temperature by about 0.07 bar every 43.7°F (6.5°C). This means that when the external temperature falls, the tyre pressure decreases. Always adjust the tyre inflation pressure when cold. This

is defined as the tyre pressure after at least 3 hours of car inactivity or travel of less than 1 mile (1.6 km) after the 3 hour interval.

The cold tyre inflation pressure must not exceed the maximum pressure indicated on the shoulder of the tyre: for further details see the instructions in the "Rims and tyres" paragraph, in the "Technical Specifications" section.

Tyre pressure increases when the vehicle is driven. This is normal, and no adjustment of the pressure is required.

The TPMS signals the driver a possible insufficient pressure if this falls below the warning limit for any reason, including the effects of low temperature and normal loss of pressure from the tyre.

The TPMS will stop indicating insufficient tyre pressure when it is equal to or greater than the prescribed cold inflation pressure.

If insufficient tyre pressure is indicated fig. 123 (⚠ symbol shown on the instrument panel display), increase the inflation pressure up to the prescribed cold inflation value.

Once the system receives the updated inflation pressures, it will automatically update and the ⚠ symbol will turn off. The vehicle might need to be driven at a speed higher than about 15.5 mph

(25 km/h) up to 20 minutes for the TPMS to receive this information.



Operating example

Supposing that the prescribed cold inflation pressure (i.e. vehicle stationary for at least 3 hours) is 33.4 psi (2.3 bar), if the ambient temperature is 68°F (20°C) and the detected tyre pressure is 28.3 psi (1.95 bar), a temperature reduction of 19.4°F (-7°C) results in a decrease in tyre pressure, bringing it to approximately 24 psi (1.65 bar).

This pressure is low enough to activate the display of the ⚠ symbol on the instrument panel display.

Heating of tyres due to driving the car may increase tyre pressure up to approximately 28.3 psi (1.95 bar), but the symbol ⚠ will stay on. In this situation, the symbol will switch off only after the tyres are inflated to the prescribed cold pressure value for the car.



WARNING

60) When driving on two-way roads where there is no lane dividing centre line (e.g. on country roads), the use of the ABS, HAS, TJA, LKA systems is strongly discouraged as this system could detect the entire carriageway as single-lane dividing lines.

61) The driving assistance systems are designed to help driving the car. The driver must always maintain a sufficient level of attention to the traffic and road conditions and for controlling the trajectory of the car.

62) The system is an aid for car driving, it DOES NOT warn the driver about incoming cars outside of the detection areas. The driver must always maintain a sufficient level of attention to the traffic and road conditions and for controlling the trajectory of the car.

63) The accident risk persists despite the application of torque to the steering wheel by the ABS system.

64) Applying a torque that corrects the steering wheel stroke does not always prevent an accident. It is always the driver's responsibility to steer, brake or accelerate, especially after the ABS system warning or after the steering wheel torque intervention. It is also recommended to always keep a safe distance to the sides. Failure to comply with these precautions may cause serious accidents and injuries.

65) In some cases, the system could apply an improper torque to the steering wheel. This application can be interrupted at any time turning the steering wheel in the opposite direction.



ABC

66) The capability of the Forward Collision Warning system must never be tested irresponsibly or dangerously, in such a way as to compromise personal safety and the safety of others.

67) The system has not been designed to prevent impacts and cannot detect possible conditions leading to an accident in advance. Failure to take into account this warning may lead to serious or fatal injuries.

68) The system may be activated, assessing the trajectory of the car, in case of reflecting metal objects different from other cars, such as safety barriers, road signs, barriers before parking lots, tollgates, level crossings, gates, railways, objects near road constructions sites or higher than the car (e.g. a flyover). In the same way, the system may intervene inside multi-storey car parks or tunnels, or due to a glare on the road surface. These possible activations are a consequence of the real driving scenario coverage by the system and must not be regarded as faults.

69) The system has been designed for road use only. If the vehicle is driven on a track, the system must be deactivated to avoid unnecessary warnings. Automatic deactivation is indicated by the dedicated warning light/symbol turning on in the instrument panel (see the instructions in the "Warning lights and messages" chapter of the "Knowing the instrument panel" section).

70) The system is an aid for the driver, who must always pay full attention while driving. The responsibility always rests with the driver, who must take into account the traffic conditions in order to drive in complete safety. The driver must always

maintain a safe distance from the vehicle in front.

71) If the driver presses the accelerator pedal fully or steers abruptly during system operation, the automatic braking function may stop (e.g. to allow a possible manoeuvre to avoid the obstacle).

72) The system intervenes on vehicles travelling in the same lane. People, animals and things (e.g. pushchairs) are not taken into consideration.

73) If the car must be placed on a roller bench for maintenance or if it is washed in an automatic car wash with an obstacle in the front part (e.g. another car, a wall or another obstacle), the system may detect its presence and activate. In this case the system must be deactivated through the settings of the Connect system.

74) The presence of the TPMS does not permit the driver to neglect regular checks of the tyre pressure, including for the spare tyre, and correct maintenance: the system is not used to signalling a possible tyre fault.

75) Tyre pressure must be checked with tyres rested and cold. Should it become necessary for whatever reason to check pressure with warm tyres, do not reduce pressure even though it is higher than the prescribed value. Repeat the check when the tyres are cold.

76) Should one or more wheels be fitted without sensors, the system will no longer be available and a warning message will be shown on the display, until wheels with sensors are fitted again.

77) The TPMS cannot indicate sudden tyre pressure drops (e.g. if a tyre bursts). In this

case, stop the car, braking with caution and avoiding abrupt steering.

78) Changes in outside temperature may cause tyre pressures to vary. The system may temporarily indicate insufficient pressure. In this case, check the tyre pressure when cold and, if necessary, restore the inflation values.

79) Replacing standard tyres with winter tyres and vice versa requires TPMS system adjustment that must only be performed by Alfa Romeo Dealerships.

80) When a tyre is removed, it is advisable to replace the rubber valve seal as well: contact an Alfa Romeo Dealership. The fitting/removal of the tyres and/or rims require special care. To avoid damaging or fitting the sensors incorrectly, tyre and/or rim fitting/removal operations should only be carried out by specialised staff. Contact an Alfa Romeo Dealership.



IMPORTANT

20) The system may have limited operation or not work at all in weather conditions such as: heavy rain, hail, thick fog, heavy snow.

21) The section of the bumper in front of the sensor must not be covered with stickers, auxiliary headlights or any other object.

22) System intervention might be unexpected or delayed when other cars transport loads projecting from the side, above or from the rear, with respect to the normal size of the car.

23) Operation can be adversely affected by any structural change made to the car, such as a modification to the front geometry,

tyre change, or a heavier load than the standard load of the car.

24) Incorrect repairs made on the front part of the car (e.g. bumper, chassis) may alter the position of the radar sensor, and adversely affect its operation. Go to an Alfa Romeo Dealership for any operation of this type.

25) Do not tamper with or carry out any intervention on the radar sensor or on the camera on the windscreen glass. In the event of a sensor failure, contact an Alfa Romeo Dealership.

26) Do not wash with high-pressure jets in the bumper lower area: in particular do not operate on the system's electrical connector.

27) Be careful in the case of repairs and new paintings in the area around the sensor (panel covering the sensor on the left side of the bumper). In the event of a frontal collision the sensor may automatically deactivate and display a warning to indicate that the sensor needs to be repaired. Even without a malfunction warning, deactivate the system operation if you think that the position of the radar sensor has changed (e.g. due to low-speed frontal collision as during parking manoeuvres). In these cases, go to an Alfa Romeo Dealership to have the radar sensor realigned or replaced.

28) When towing a trailer, a car or during loading manoeuvres on a car transporter (or in car for transport), the system must be deactivated via the Connect system.

29) The Tyre Repair Kit, provided with the car, is compatible with the TPMS sensors. Using sealants different from that in the original kit may compromise its operation.

If sealants not equivalent with the original one are used, it is recommended to have the TPMS sensor operation checked by a qualified repair centre.

30) The TPMS is designed for original tyres and wheels. The prescribed pressures and consequent alarm thresholds set in the TPMS are based on the dimensions of the tyres fitted on the car. Using spare wheels of a size, type and/or design different from the original ones may cause an irregular operation of the system and damage the sensors. Aftermarket fitted wheels may damage the sensors. Using aftermarket tyre sealants may damage the Tyre Pressure Monitoring System (TPMS) sensor. If aftermarket tyre sealant is used it is recommended to go to an Alfa Romeo Dealership to have the sensors checked. After checking or adjusting the tyre of the pressure, always refit the valve cap to prevent humidity and dirt from entering, these may damage the Tyre Pressure Monitoring System sensor.

DAA (Driver Attention Assist) SYSTEM

(where provided)

This is an auxiliary driving assistance system that detects when the driver is tired.



ACTIVATION / DEACTIVATION

The system can be activated/deactivated using the "Driver Assistance" menu and then selecting "Safety" on the Connect system.

SYSTEM INTERVENTION

Using information from the front camera, the system implements two operating logics:

- the first operating logic takes the driving style into account, observing the road and detecting to what extent the driver can continue driving with few oscillations and few lane marking crossing events;
- the second operating logic measures the time spent behind the wheel with the vehicle speed is above 60 km/h and below 180 km/h. If the "Standard" option is selected, in these conditions, the "dozy driver" message may appear after 3 hours of driving. If the "Early" option is selected and these conditions occur, the "dozy driver" message will be displayed after 2 hours of driving.



ABC

NOTE If the conditions described above are not detected continuously during the entire driving period, the "dozy driver" message may be displayed later than 2 or 3 hours. If the driving style indicates that the driver is unable to follow the road trajectory and respect the horizontal lane markings, the red symbol fig. 124 will appear on the instrument panel display to suggest that the driver should stop for a break. An auditory signal is also emitted.



124

9550227

□ If the driver **accepts** the suggestion provided by the system by pressing the "MENU VIEW" button on the right steering wheel stalk and stopping for a pause, the message will disappear from the display and the symbol ☕ will be displayed in the right dial of the instrument panel display fig. 125 up to the next engine shutdown/restart.

□ if the driver **ignores** the warning provided by the system and does not stop, the message will continue to remain on the display, together with the symbol ☕ in the right dial of the instrument panel display fig. 125.



125

9550226

In the second case, a dedicated message is shown on the instrument panel display and disappears automatically after a few seconds.

In the event of a primary intervention, with the ☕ symbol (red) shown on the display, the secondary event is not considered/monitored.

WARNING If the ABS system activates, the word "ABS ACTIVE" will be displayed instead of the symbol ☕ (red) and it will remain active until the ABS system finishes its operation.

WARNING In the event of a system fault, the amber ☕ symbol appears on the

instrument panel display together with a dedicated message.

Changing the system sensitivity

The system intervention sensitivity can be adjusted using the "Driver Assistance" menu and then selecting "Safety" on the Connect system.

WARNING If the "Race" mode is used (where provided), the DAA system is automatically deactivated and it will therefore not be possible to change its sensitivity.

WARNING In the case of camera failure, the system sensitivity cannot be changed.



WARNING

81) *The DAA system is an aid for driving and does not relieve the driver of responsibility for driving the car. If you experience fatigue while driving, pull over safely for a break without waiting for the DAA to intervene. Only get back on the road when you are in the right physical and mental condition to prevent endangering yourself and other road users.*

OCCUPANT PROTECTION SYSTEMS

The following protection systems are among the vehicle's most important safety equipment:

- seat belts;
- SBA (Seat Belt Alert) system;
- head restraints;
- child restraint systems;
- Front airbags and side bags.

Read the information given the following pages with the utmost care. It is of fundamental importance that the protection systems are used in the correct way to guarantee the maximum possible safety level for the driver and the passengers.

For the description of the head restraint adjustment, see the "Head restraints" chapter in the "Knowing your car" section.

SEAT BELTS

All the seat belts have three anchor points and a retractor.

The reel mechanism operates locking the belt in the event of sharp braking or strong deceleration due to an impact. This allows the belt strap to slide freely and to adapt to the body of the occupant. In the event of an accident, the belt will lock reducing the risk of impact inside the passenger compartment and of being projected outside the car.

The driver is responsible for respecting, and ensuring that all the other occupants of the vehicle also respect, the local laws in force in relation to the use of the seat belts.

Always fasten the seat belts before setting off.

USING THE SEAT BELTS

The seat belt should be worn keeping the chest straight and rested against the backrest.

To fasten the seat belts, hold fastening tongue (1) fig. 126 and insert it into buckle (2), until it clicks into place.



126

06056V0001EM

On removal of the belt, if it jams, let it rewind for a short stretch, then pull it out again without jerking.

To unfasten the seat belts, press button (3) and guide the seat belt with your hand while it is rewinding, to prevent it from twisting.



The retractor may lock when the car is parked on a steep slope: this is perfectly normal. Furthermore, the reel mechanism locks the belt if it is pulled sharply or in the event of sudden braking, collisions and high-speed bends.

Wear the rear seat belts as shown in fig. 127 and fig. 128.



ABC

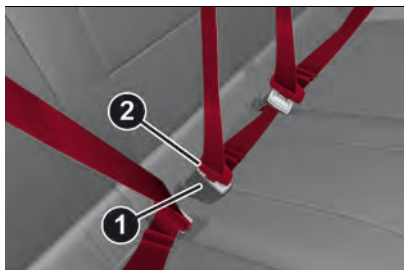

127

06056V0005EM

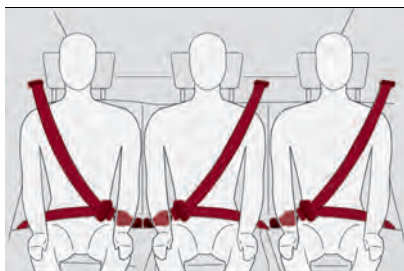

128

06056S0003EM



83)

ADJUSTING THE SEAT BELT HEIGHT

Four different adjustments in height are possible.

To adjust the window height, from the top downwards, press the button (4) fig. 129 and slide the handle downwards.

The height adjuster moves upwards even without pressing the button.

Always adjust the height of the seat belts to fit the person wearing it: this

precaution could greatly reduce the risk of injury in the event of a crash.

Correct adjustment is obtained when the belt passes approximately half way between the shoulder and the neck.

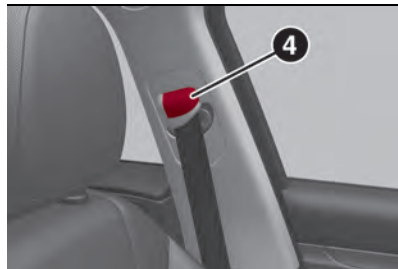

129

06056V0002EM



84) 85)



WARNING

82) Never press button (3) when travelling.

83) Remember that in the event of an accident, the rear seat passengers not wearing seat belts are exposed to a very serious risk and also represent a serious danger for the front seat occupants.

84) Make height adjustment of the seat belts when the car is stationary.

85) After height adjustment, always check that the cursor to which the ring is fastened is locked in one of the preset positions. To do this, with the adjustment button released, exert further pressure downwards to allow the locking device to click if the grip

has not been released in one of the possible positions.

SBA (Seat Belt Alert) SYSTEM

The SBR system warns the passengers of the front and rear (where provided) seats if their seat belt is not fastened.

The system warns unfastened seat belts with visual warnings (warning lights on in the instrument panel and icons on the display) and an acoustic warning (see the following paragraphs).

NOTE To disable the acoustic warning permanently, go to an Alfa Romeo Dealership. The horn can be reactivated at any time through the display Menu (see the "Display" chapter in the "Knowing the instrument panel" section).

FRONT SEAT BELT ICON BEHAVIOUR

At speeds of the car below 20 km/h, the symbol  fig. 130 is red if the driver's seat belt is not fastened or the passenger's seat belt is not fastened (with a passenger seated).

As soon as a speed threshold of 20 km/h is reached, with driver side seat belt or the passenger side seat belt (with occupant seated) unfastened, an acoustic signal is activated simultaneously with symbol (1) flashing in red for about 105 seconds.

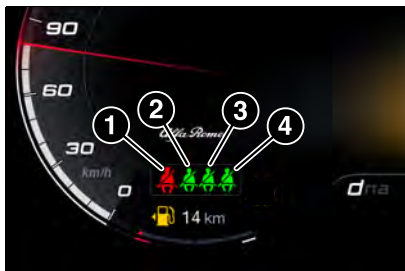

130

9550202

Once activated, this warning cycle stays active for the entire time if the car is moving faster than 8 km/h or if reverse gear is not engaged or until the seat belts are fastened.

When the reverse is engaged, during the cycle of warnings, the acoustic warning is deactivated and the red symbol (1) turns on fixed. The warning cycle will be reactivated as soon as the car exceeds 18 mph (20 km/h) again.

If the car speed drops to less than 5 mph (8 km/h) or if reverse gear is engaged during the warning cycle, the tone will be interrupted and the warning light turns on fixed red.

If the entire time has not elapsed and reverse gear is not engaged, the indication cycle is reactivated as soon as the car speed 18 mph (20 km/h) again.

REAR SEAT BELT ICON BEHAVIOUR

(where provided)

The icons (2)/(3)/(4) fig. 130 on the instrument panel display indicate:

- (2) rear left seat belt
- (3) rear central seat belt
- (4) rear right seat belt

With the car travelling at speed lower than 20 km/h, if a rear seat belt is unbuckled, the icon stays on with fixed light for a total of approximately 65 seconds.

The icons are displayed according to the corresponding rear seat belts and stay on for about 65 seconds from the last seat belt status change:

- if the seat belt is fastened the corresponding icon will be green
- if the seat belt is unfastened the corresponding icon will be red

Furthermore, the icons light up for a few seconds whenever one of the rear doors is opened.

If the car is travelling at a speed faster 18 mph (20 km/h) and reverse is not engaged, if a rear seat belt is unbuckled, an acoustic warning is sounded when the icon blinks for approximately 35 seconds. Successively, the acoustic warning is deactivated and the icon lights up with fixed light until the end of the entire cycle.

With the SBA system enabled, whenever the ignition device is moved to MAR, the presence of an object on the rear seat is detected if a rear door has previously been opened for at least 1 second and the ignition device has been moved to AVV in the previous 10 minutes. If an object is detected, a dedicated message appears on the instrument panel display suggesting to check the rear seat for objects before exiting the car. Furthermore, when exiting the vehicle, a second message appears on the instrument panel display to remind you that there are objects on the rear seat.

WARNINGS

As far as the rear seats are concerned, the SBA system will only indicate whether the seat belts are unfastened (red icon) or fastened (green icon), not the presence of any passengers.

The icons all stay off if all seat belts (front seats and rear seats) are fastened when the ignition device is set to ON.

For the rear seats, the icons will activate a few seconds after the ignition device has been turned to ON, regardless of the status of the seat belts (even if the seat belts are all fastened).

All the icons will turn on when at least one seat belt changes from fastened to unfastened status or vice versa.



ABC

PRE-TENSIONERS

The car is equipped with front and rear lateral seat belt pretensioners, which draw back the seat belts by several centimetres in the event of a strong frontal impact. This guarantees the perfect adherence of the seat belts to the occupant's bodies before the retention action begins.

It is evident that the pretensioners have been activated when the belt withdraws toward the retractor.

This car is also equipped with a second pretensioner on the front seat belts (fitted in the kick plate area). Its activation is signalled by the shortening of the metal cable.

A slight discharge of smoke may be produced during the activation of the pretensioner which is not harmful and does not involve any fire hazard.

A slight discharge of smoke may be produced during the activation of the pretensioner which is not harmful and does not involve any fire hazard.

If, due to unusual natural events (floods, sea storms, etc.), the device has been affected by water and/or mud, contact an Alfa Romeo Dealership to have it replaced.

WARNING To obtain the highest degree of protection from the action of the

pretensioner, wear the seat belt tight to the torso and pelvis.

LOAD LIMITERS



To increase safety in the event of an accident, the front and rear lateral seat belt retractors contain a load limiter which controls the force acting on the chest and shoulders during the belt restraining action in the event of a head-on collision.

GENERAL INSTRUCTIONS FOR USING THE SEAT BELTS

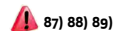

Respect and ensure that all the other occupants of the vehicle comply with the local laws in force regarding the use of seat belts.

Always fasten the seat belts before setting off.

Seat belts must also be worn by pregnant women: the risk of injury in the event of an accident is reduced for them and the unborn child if they are wearing a seat belt.

Pregnant women must position the lower part of the belt very low down so that it passes over the pelvis and under the abdomen fig. 131. While pregnancy progresses, the driver must adjust both seat and steering wheel to have full

control over the vehicle (pedals and steering wheel must be easy to access). The maximum clearance should be kept between the abdomen and the steering wheel.

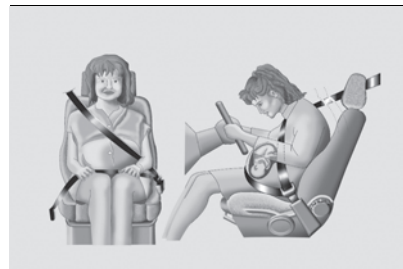

131

0607650001EM

The seat belt strap must not be twisted. The upper part must pass over the shoulder and cross the chest diagonally. The lower part must adhere to the pelvis fig. 132, not to the abdomen of the occupant. Never use devices (clips, clamps, etc.) that hold the seat belt away from your body.

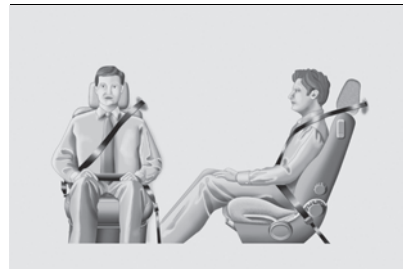

132

0607650002EM

Each seat belt must be used by only one person. Never travel with a child sitting on the passenger's lap and a single belt to protect them both fig. 133. In general, do not place any objects between the person and the belt.



133

0607650003EM

SEAT BELTS MAINTENANCE

For keeping the seat belts in efficient conditions, carefully observe the following warnings:

- always use the seat belt well stretched and never twisted; make sure that it is free to run without obstructions;
- always use the seat belt well stretched and never twisted; make sure that it is free to run without obstructions;
- replace the seat belt after an accident of a certain severity even if it does not appear to be damaged. Always replace the seat belt if the pretensioners were deployed;

- prevent the retractors from getting wet: their correct operation is only guaranteed if water does not get inside;
- replace the seat belt when it shows wear or cuts.



WARNING

- 86)** *The pretensioner may be used only once. After its activation, contact an Alfa Romeo Dealership to have it replaced.*
- 87)** *Removing or otherwise tampering with pretensioner and seat belt components is strictly prohibited. Any intervention on these components must be performed by qualified and authorised technicians. Always contact an Alfa Romeo Dealership.*
- 88)** *For maximum safety, keep the backrest upright, lean back into it and make sure the seat belt fits closely across your chest and pelvis. Always fasten the seat belts for both the front and rear seats! Travelling without wearing seat belts will increase the risk of serious injury and even death in the event of an accident.*
- 89)** *If the belt has been subjected to high levels of stress, for example after an accident, it should be changed completely together with the attachments, attachment fixing screws and the pretensioner. In fact, even if the belt has no visible defects, it may have lost its resilience.*



IMPORTANT

31) *Operations which lead to impacts, vibrations or localised heating (over 100°C for a maximum of six hours) in the area around the pretensioner may cause damage or make it deploy. Contact an Alfa Romeo Dealership should intervention be necessary on these components.*

CHILD RESTRAINT SYSTEMS

CARRYING CHILDREN SAFELY

90) 91) 92) 93)

For optimal protection in the event of an impact, all occupants must be seated and wearing adequate restraint systems, including newborn and other children!

This prescription is compulsory in all EC countries according to EC Directive 2003/20/EC.

Children below the height of 4.9 ft (1.50 metres) and up to 12 years must be protected with suitable restraint systems and be seated on the rear seats. Statistics on accidents indicate that the rear seats offer greater safety for children.

Compared with an adult, a child's head is larger and heavier in proportion to their body and the child's muscular and bone structures are not fully developed. Therefore, correct restraint systems



ABC

other than adult seat belts are necessary, to reduce as much as possible the risk of injuries in the event of an accident, braking or sudden manoeuvre.

Children must be seated safely and comfortably. As far as the characteristics of the child seats used allow, you are advised to keep children in rearward facing child seats for as long as possible (at least until 3–4 years old), since this is the most protected position in the event of a collision.

The choice of the most suitable child restraint system depends on the weight and size of the child. There are various types of child restraint systems, which can be secured to the car by means of the seat belts or with the ISOFIX/i-Size anchorages.

It is recommended to always choose the restraint system most suitable for the child; for this reason always refer to the Owner Handbook provided with the child restraint system, to be sure that it is of the right type for the children it is intended for.



WARNING

90) SEVERE DANGER When a front passenger airbag is fitted, do not install rearward facing child restraint systems on the front passenger seat. Deployment of the

airbag in a crash could cause fatal injuries to the child regardless of the severity of the collision. It is advisable to always carry children in a child restraint system on the rear seat, which is the most protected position in the event of a collision.

91) On the sun visor there is a label with suitable symbols reminding the user that it is compulsory to deactivate the airbag if a rearward facing child restraint system is fitted. Always comply with the instructions on the passenger side sun visor (see the “Supplementary Restraint System (SRS) - Airbag” chapter).

92) Should it be necessary to carry a child on the passenger side front seat in a rear facing child restraint system, the passenger side front air bag and side bag must be deactivated through the Connect system main menu (see the Supplementary Restraint System (SRS) - Air bag” chapter), verifying deactivation by checking whether the  **OFF** LED has illuminated on the front courtesy light. Move the passenger’s seat as far back as possible to avoid contact between the child seat and the dashboard.

93) Do not move the front or rear seat if a child is seated on it or on the dedicated child restraint system.

In Europe the characteristics of child restraint systems are governed by regulation ECE-R44, which divides them into five weight groups.

The ECE-R44 standard has been paired with the ECE R-129 regulation, which defines the characteristics of the new i-Size child restraint systems (see the "Suitability of passenger seats for i-Size child restraint system use" paragraph).

Group	Age	Weight groups	Size class / Fixing
Group 0	Indicatively up to 9 months	up to 22 lb (10 kg) in weight	ISO/L1
			ISO/L2
			ISO/R1
Group 0+	Indicatively up to 2 years	up to 26.7 lb (13 kg) in weight	ISO/R1
			ISO/R2
			ISO/R3
Group 1	Indicatively from 8 months to 4 years	20 - 40 lb (9 - 18 kg) in weight	ISO/R2
			ISO/R3
			ISO/F2
Group 2	Indicatively from 3 to 7 years	33 - 55 lb (15 - 25 kg) in weight	ISO/F2X
			ISO/F3
			-
Group 3	Indicatively from 6 to 12 years	48.5 - 79.4 lb (22 - 36 kg) in weight	-

All restraint devices must bear the type-approval data, together with the control mark, on a label solidly fixed to the child restraint system which must never be removed.



ABC

Lineaccessori MOPAR® includes child restraint systems for each weight group. These devices are recommended having been specifically tested for Alfa Romeo cars.

WARNING For correct installation on the car, some universal child restraint systems require an accessory (base) sold separately by the restraint system's producer. Therefore, FCA recommends confirming the retailer if the desired child seat can be installed in the car by having it done, before buying the seat.

INSTALLING A CHILD RESTRAINT SYSTEM WITH SEAT BELTS

The Universal child restraint systems installed with the seat belts only are type-approved on the basis of the ECE R44 standard and are divided into various weight groups.

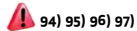

94) 95) 96) 97)

WARNING The figures are indicative and provided for assembly purposes only. Fit the child restraint system according to the instructions, which must be included.

Group 0 and 0+

Infants up to 28.7 lb (13 kg) must be carried with a rearward facing child restraint system of the type shown in fig. 134 which, supporting the head, does

not induce stress on the neck in the event of sudden decelerations.



The child restraint system is restrained by the car seat belts, as shown in fig. 134 and it must restrain the child in turn with its own belts.

Group 1

Children weighing from 9 to 40 lb (18 kg) may be transported in forward facing child restraint systems fig. 135.



Group 2

Children from 33 to 55 lb (15 to 25 kg) may be restrained directly by the car seat belts fig. 136.

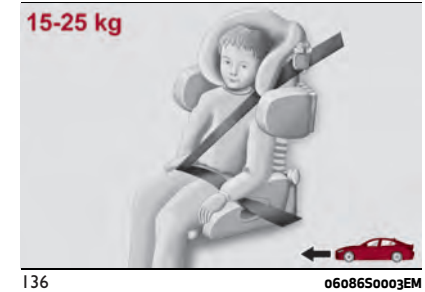

In this case, the child restraint system is used to position the child correctly with respect to the seat belts so that the diagonal belt section crosses the child's chest and not the neck, and the lower part is snug on the pelvis not the abdomen.

Group 3

For children from 48.5 to 79.4 lb (22 to 36 kg), there are restraining devices that allow the seat belts to pass through properly.

The fig. 137 shows the correct child positioning on the rear seat.



137

06086S0004EM

Children over 4.9 ft (1.50 m) tall wear seatbelts like adults.



WARNING

94) *Incorrect fitting of the child restraint system may result in an inefficient protection system. In the event of an accident the child restraint system may become loose and the child may be injured, even fatally. When fitting a restraint system for newborns or children, strictly comply with the instructions provided by the Manufacturer.*

95) *When the child restraint system is not used, secure it with the seat belt or with the ISOFIX anchorages, or remove it from the car. Do not leave it unsecured inside the passenger compartment. In this way, in the event of sudden braking or an accident, it will not cause injuries to the occupants.*

96) *After installing a child restraint system, do not move the seat: always remove the child restraint system before making any adjustment.*

97) *Always make sure that the chest section of the seat belt does not pass under the arms or behind the back of the child. In the event of an accident the seat belt will not be able to secure the child, with the risk of injury, including fatal injury. Therefore the child must always wear the seat belt correctly.*

INSTALLING AN ISOFIX CHILD RESTRAINT SYSTEM

! 98) 99) 100) 101) 102)

The rear side seats of the car are equipped with ISOFIX attachments, for fitting child restraint systems quickly, simply and safely.

The ISOFIX system lets you install the ISOFIX child restraining system without using the car seat belts but connecting them directly to the carseat with three anchors in the car.

You can use the traditional mixed mounting carseats and ISOFIX in different places in the same car.

To install an ISOFIX child restraint system, attach it to the two metal anchors fig. 138. They can be reached by lifting the flaps 2 located behind the rear seat cushion, at the point where it meets the backrest. Then fix the upper hook (available with the child restraint system) to the dedicated "top tether" anchor fig. 139 located behind the seat backrest.

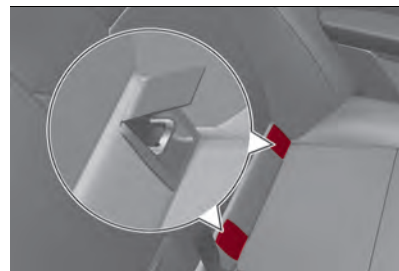

138

06086V0009EM

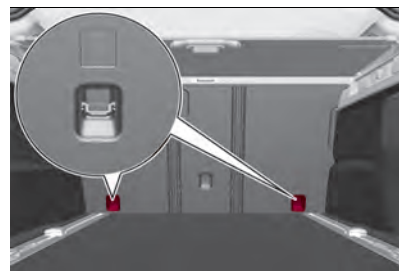

139

06086V0005EM

fig. 140 shows an example of a Universal ISOFIX child restraint system for weight group 1.

WARNING The fig. 140 is indicative and for assembly purposes only. Fit the child restraint system according to the instructions, which must be included.



ABC

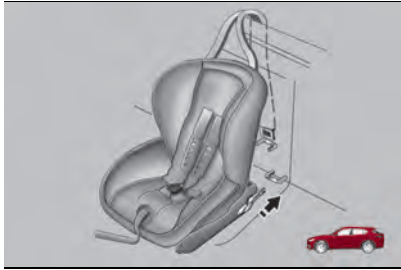

140

06086V006EM

NOTE When a Universal ISOFIX child restraint system is used, only ECE R44 "ISOFIX Universal" (R44/03 or further upgrades) type-approved child restraint systems can be used (see fig. 141).

The other weight groups are covered by specific ISOFIX child restraint systems, which can be used only if specifically tested for this car (see list of cars provided with the child restraint system).

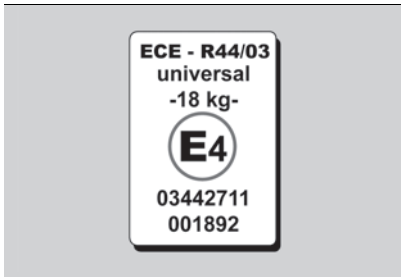

141

06086S0007EM



WARNING

98) Do not use the same lower anchoring to install more than one child restraint system.

99) If a Universal ISOFIX child restraint system is not fixed to all three anchorages, it will not be able to protect the child correctly. In a crash, the child could be seriously or fatally injured.

100) Fit the child restraint system when the car is stationary. The child restraint system is correctly secured to the brackets when you hear the click. Follow the instructions for assembly, disassembly and positioning that the Manufacturer must supply with the child restraint system.

101) If the car was involved in an accident of a certain severity, have the ISOFIX anchorages and the child restraint system replaced.

102) If the car was involved in an accident of a certain severity, have both the child restraint system and the seat belt it was attached to replaced.

i-Size CHILD RESTRAINT SYSTEMS

The rear side seats of the car are type-approved to house the state-of-the-art i-Size child restraint systems.

These child restraint systems, built and type-approved according to the i-Size (ECE R129) standard, ensure better

safety conditions to carry children on board a vehicle:

- the child must be transported rearward facing until 15 months;
- child restraint system protection is increased in the event of a side collision;
- the use of the ISOFIX system is promoted to avoid faulty installation of the child restraint system;
- efficiency in the choice of the child restraint system, which isn't made according to weight any more but according to the child's height, is increased;
- compatibility between the vehicle seats and the child restraint systems is better: the i-Size child restraint systems can be considered as "Super ISOFIX"; this means that they can be perfectly fitted in type-approved i-Size seats, but can also be fitted in ISOFIX (ECE R44) type-approved seats.

NOTE If your car seats are i-Size approved, the symbol shown in fig. 142 will appear on the seats near the ISOFIX attachments.



142

0608650008EM

NOTE See the table shown on the following page to check whether your car is approved for installing i-Size child restraint systems.



ABC

Child restraint system installation

The following table provides guidelines on positioning child restraint systems on the vehicle seats. Each child restraint system position complies with the UNECE standards.



Seat number	Number of seats						6
	1	2	3		4	5*	
			Airbag ENABLED	Airbag DISABLED			
Seat suitable for universal rearward facing child restraint systems	X	X	NO	YES (U)	YES (U)	X	YES (U)
Seat suitable for universal forward facing child restraint systems	X	X	YES (UF) ^(a)	NO	YES (UF)	X	YES (UF)
i-Size seat	X	X	NO	NO	YES (i-U)	X	YES (i-U)
Seat suitable for ISOFIX side child restraint systems (L1 / L2)	X	X	NO	NO	NO	X	NO
Seat suitable for ISOFIX rearward facing child restraint systems (R1 / R2 / R3)	X	X	NO	NO	YES (IL) ¹	X	YES (IL) ¹

Seat number	Number of seats						
	1	2	3		4	5*	6
			Airbag ENABLED	Airbag DISABLED			

Seat suitable for ISOFIX forward facing child restraint systems (F2 / F2X / F3)	X	X	NO	NO	YES (IUF)	X	YES (IUF)
Seat suitable for auxiliary child restraint systems (B2 / B3)	X	X	NO	NO	YES (Only B2) (IUF)	X	YES (Only B2) (IUF)

U = Position suitable for a "universal" child restraint system approved for this weight category.

UF = Position suitable for a "universal" forward facing child restraint system approved for this weight category.

IUF = Position suitable for an "ISOFIX" universal forward facing child restraint system approved for this weight category.

i-U = Position suitable for an i-Size "universal" forward facing or rearward facing child restraint system.

i-UF = Position suitable for an i-Size "universal" forward facing child restraint system.

IL = Position suitable for specific listed ISOFIX child restraint systems (CRS). These ISOFIX CRS are classified as "vehicle-specific", "restricted use" and "semi-universal".

X = Not applicable. The seat is not approved for installation of child restraint systems.

(a) = With forward facing child restraint system, the seat must be positioned no more forward than the longitudinal halfway point.

1 = The ISOFIX child restraint system can be installed by adjusting the front seat (for R3 fixtures).

* = Child restraint systems with support leg cannot be installed on this seat

Remove/adjust the head restraint (if adjustable) if it interferes with installation of the child restraint system.



ABC

Child restraint system installation (right-hand drive version)

The following table provides guidelines on positioning child restraint systems on the vehicle seats. Each child restraint system position complies with the UNECE standards.



Seat number	Number of seats						
	1		2	3	4	5*	6
	Airbag ENABLED	Airbag DISABLED					
Seat suitable for universal rearward facing child restraint systems	NO	YES (U)	X	X	YES (U)	X	YES (U)
Seat suitable for universal forward facing child restraint systems	YES (UF) ^(a)	NO	X	X	YES (UF)	X	YES (UF)
i-Size seat	NO	NO	X	X	YES (i-U)	X	YES (i-U)
Seat suitable for ISOFIX side child restraint systems (L1 / L2)	NO	NO	X	X	NO	X	NO
Seat suitable for ISOFIX rearward facing child restraint systems (R1 / R2 / R3)	NO	NO	X	X	YES (IL) ¹	X	YES (IL) ¹

Seat number	Number of seats						
	1		2	3	4	5*	6
	Airbag ENABLED	Airbag DISABLED					
Seat suitable for ISOFIX forward facing child restraint systems (F2 / F2X / F3)	NO	NO	X	X	YES (IUF)	X	YES (IUF)
Seat suitable for auxiliary child restraint systems (B2 / B3)	NO	NO	X	X	YES (Only B2) (IUF)	X	YES (Only B2) (IUF)

U = Position suitable for a "universal" child restraint system approved for this weight category.

UF = Position suitable for a "universal" forward facing child restraint system approved for this weight category.

IUF = Position suitable for an "ISOFIX" universal forward facing child restraint system approved for this weight category.

i-U = Position suitable for an i-Size "universal" forward facing or rearward facing child restraint system.

i-UF = Position suitable for an i-Size "universal" forward facing child restraint system.

IL = Position suitable for specific listed ISOFIX child restraint systems (CRS). These ISOFIX CRS are classified as "vehicle-specific", "restricted use" and "semi-universal".

X = Not applicable. The seat is not approved for installation of child restraint systems.

(a) = With forward facing child restraint system, the seat must be positioned no more forward than the longitudinal halfway point.

1 = The ISOFIX child restraint system can be installed by adjusting the front seat (for R3 fixtures).

* = Child restraint systems with support leg cannot be installed on this seat

Remove/adjust the head restraint (if adjustable) if it interferes with installation of the child restraint system.



ABC

CHILD RESTRAINT SYSTEMS RECOMMENDED BY ALFA ROMEO FOR YOUR STELVIO

Lineaccessori Alfa Romeo includes a complete range of child restraint systems to be fixed using the seat belt with three anchorage points or the ISOFIX anchorages.

WARNING Alfa Romeo recommends fitting the child restraint system according to the instructions, which must be included.

Weight group	Child restraint system	Type of child restraint system	Child restraint system installation
<p>Group 0+: from birth to 28.7 lb (13 kg) from 15.7 to 33.5 in (from 40 to 85 cm)</p>		<p>Peg Perego Primo Viaggio i-Size Order code AR: 50290501</p> <p>+</p> <p>Peg Perego Base i-Size Order code AR: 50290505</p>	<p>i-Size universal child restraint system. It is installed in the opposite direction to the travel direction with the mandatory use of the i-Size sub-base (can be purchased together with the child restraint system or separately) and the isofix anchorages of the car.</p> <p>It must be fitted on the rear outer seats.</p>

Group 0+/1: from birth to 28.7 lb (13 kg) from 15.7 to 33.5 in (from 40 to 85 cm)



Peg Perego Viaggio FF105

Order code AR: 50290502

+

Peg Perego Base i-Size

Order code AR: 50290505

i-Size approved child restraint system. It must be installed on the car absolutely together with the Peg Perego Base i-Size sub-base (to be purchased separately or together with the Peg Perego Primo Viaggio i-Size child restraint system).

It must be fitted on the rear outer seats.

Group 2: from 33 to 55 lb (from 15 to 25 kg) from 37.4 to 53 in (from 95 to 135 cm)



Peg Perego Viaggio 2-3 Shuttle Plus

(for versions/markets, where provided)

Order code AR: 50290504

It can only be fitted facing forwards, using the three-point seat belt and the ISOFIX anchorages of the car.

Alfa Romeo recommends to install it using the ISOFIX anchorages of the car.

It must be fitted on the rear outer seats.



Weight group

Group 3: from 48.5 to 79.4 lb (from 22 to 36 kg) from 53.5 to 59 in (from 136 to 150 cm)

Child restraint system



Type of child restraint system

Peg Perego Viaggio 2-3 Shuttle Plus
(for versions/markets, where provided)
Order code AR: 50290504

Child restraint system installation

It can only be fitted facing forwards, using the three-point seat belt and the ISOFIX anchorages of the car.
Alfa Romeo recommends to install it using the ISOFIX anchorages of the car.
It must be fitted on the rear outer seats.

Main recommendations to carry children safely

- ❑ Install the child restraint systems on the rear seat, which is the most protected position in the event of a collision.
- ❑ Keep children in rearward facing child restraint systems for as long as possible, until 3–4 years old if possible.
- ❑ The rear head restraint or the front passenger head restraint can be lifted if needed to install a child restraint system. The head restraint must always be present in the vehicle and fitted if the seat is used by an adult passenger or a child sitting in a restraint system without backrest (refer to the procedure described in “Head restraint” chapter, “Knowing your vehicle” section).
- ❑ If the front passenger airbag has been deactivated, always check that the warning light on the courtesy light is on continuously to make sure that it is effectively deactivated.
- ❑ Carefully follow the instructions supplied with the child restraint system. Keep the instructions in the car along with the other documents and this handbook. Do not use second-hand child seats without instructions.
- ❑ Only one child is to be strapped into each restraint system; never carry two children using one child restraint system.

- ❑ Always check that the seat belts do not rest on the child’s neck.
- ❑ Always check that the seat belt is well fastened by pulling on it.
- ❑ While travelling, do not let the child sit incorrectly or unfasten the belts.
- ❑ Never allow a child to put the belt’s diagonal section under an arm or behind their back.
- ❑ Never carry children on your lap, even newborns. No-one can hold a child in the case of a collision.
- ❑ In the event of an accident, replace the child restraint system with a new one.

SUPPLEMENTARY RESTRAINT SYSTEM (SRS) - AIRBAG

The car is equipped with:

- ❑ front driver airbag;
- ❑ front passenger airbag;
- ❑ driver and passenger front side bags for pelvis, chest and shoulder protection (Side bags);
- ❑ side bags for head protection of front seat passengers and rear side seat passengers (window bag).

The location of the airbags on the car is marked by the word “AIRBAG” under the Alfa Romeo emblem on the steering wheel, on the dashboard, on the side trim or on a label placed next to the airbag deployment area.

FRONT AIRBAGS

The front (driver and passenger) airbags protect the front seat occupants in the event of head-on crashes of medium-high severity, by placing the cushion between the occupant and the steering wheel or dashboard.

Therefore non-activation of airbags in other types of collisions (side impacts, rear shunts, roll-overs, etc.) does not indicate a system malfunction.

Driver and passenger front airbags are not a replacement of but complementary to the seat belts, which should always be worn, as specified by law in Europe and most non-European countries.

In a crash, those not wearing a seat belt are projected forwards and may come into contact with the bag which is still inflating. The protection offered by the bag is compromised in these circumstances.

Front airbags may not activate in the following situations:

- ❑ frontal impacts against highly deformable objects not involving the front surface of the car (e.g. wing collision against safety barrier, etc.);
- ❑ car wedging under other cars or safety barriers (e.g. trucks or guard rails).

Failure to activate in the conditions described above is due to the fact that they may not provide any additional



ABC

protection compared with seat belts, so their activation would be inappropriate. In these cases, non-deployment does not indicate a system malfunction.

Driver's side front airbag

This consists of an instantly inflating bag contained in a special compartment in the centre of the steering wheel fig. 143.



143

06106V0020EM

Passenger's front airbag

This consists of an instantly inflating bag contained in a special recess in the dashboard fig. 144: this bag has a larger volume than that on the driver side.

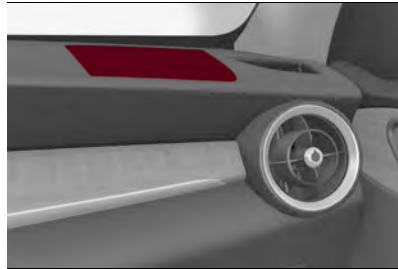

144

06106V0002EM

Passenger's front airbag and child restraint systems

Rearward-facing child restraint systems must **NEVER** be fitted on the front seat with an active passenger side airbag since in the event of a collision the airbag activation may cause fatal injuries to the transported child.

ALWAYS comply with the instructions on the label stuck on the sun visor on passenger side (A) or on driver side (B) fig. 145 and shown in table on the following pages.

A



B



145

9490193

Deactivating/activating the passenger side airbags: front air bag and side bag (where provided)

To deactivate the front and side passenger side airbag, use the Connect system. Select the following functions in succession from the main Menu, and activate them by pressing the  fig. 146 button: "Settings", "Safety", "Passenger Airbag". The system will check airbag activation/deactivation status and request confirmation of change of status.



146

05036V0099EM



147

0610650376EM

On the dashboard are the ON and OFF LED status. Moving the ignition device to MAR, the two LEDs switch on for a few seconds. If not, contact an Alfa Romeo Dealership. During the first seconds, the activation of the LEDs does not actually show the passenger protection status, but only checks its correct operation.

After a test of a few seconds, the LEDs will indicate the status of the passenger airbag protection.

Passenger protection activated: the ON LED fig. 147 switches on fixed.

Passenger protection deactivated: the OFF LED turns on fixed.



ABC

Passenger's front airbag and child restraint systems: IMPORTANT

I	RISCHIO DI FERITE GRAVI O MORTALI. I seggiolini bambino che si montano nel verso opposto a quello di marcia non vanno installati sui sedili anteriori in presenza di air bag passeggero attivo.
GB	DEATH OR SERIOUS INJURY CAN OCCUR. NEVER use a rearward facing child restraint on a seat protected by an ACTIVE AIRBAG in front of it, DEATH or SERIOUS INJURY to the CHILD can occur
F	RISQUE DE MORT OU DE BLESSURES GRAVES. NE PAS positionner le siège pour enfant tourné vers l'arrière, en cas d'air bag passager actif.
D	Nichtbeachtung kann TOD oder SCHWERE VERLETZUNGEN zur Folge haben. Rückwärts gerichtete Kinderrückhaltesysteme (Babyschale) dürfen nicht in Verbindung mit aktiviertem Beifahrerairbag auf dem Beifahrersitz verwendet werden
NL	DIT KAN DODELIJK ZIJN OF ERNSTIGE ONGELUKKEN VEROORZAKEN. Plaats het kinderstoeltje niet ruggelings op de voorstoel wanneer er een airbag aanwezig is.
E	PUEDE OCACIONAR MUERTE O HERIDAS GRAVES. NO ubicar el asiento para niños en sentido inverso al de marcha en el asiento delantero si hubiese airbag activo lado pasajero.
PL	MOŻE GROZIĆ ŚMIERCIĄ LUB CIEŻKIMI OBRAŻENIAMI. NIE WOLNO umieszczać fotelika dziecięcego tyłem do kierunku jazdy na przednim siedzeniu w przypadku zainstalowanej aktywnej poduszki powietrznej pasażera.
TR	ÖLÜM VEYA AĞIR ŞEKİLDE YARALANMAYA SEBEP OLABİLİR. Yolcu airbag'i aktif halde iken çocuk koltuğunu araç gidis yönüne ters biçimde yerleştirmeyin.
DK	FARE FOR DØDELIGE KVÆSTELSER OG LIVSTRUENDE SKADER. Placer aldrig en bagudvendt barnstol på passagerersædet, hvis passager-airbagen er indstillet til at være aktiv (on).
EST	TAGAJÄRJESKUS VÕIVAD OLLA TÕSISED KEHAVIGASTUSED VÕI SURM. Turvapadja olemasolu korral ärge asetage lapse turvalistet sõidusuunaga vastassuunas.
FIN	KUOLEMANVAARA TAI VAKAVIEN VAMMOJEN UHKA. Älä aseta lasten turvaistuinta niin, että lapsi on selkä menosuuntaan, kun matkustajan airbag on käytössä.
P	RISCO DE MORTE OU FERIMENTOS GRAVES. Não posicionar o banco para crianças numa posição contrária ao sentido de marcha quando o airbag de passageiro estiver activo.
LT	GALI IŠTIKTI MIRTIS ARBA GALITE RIMTAI SUSIŽEISTI. Nedėkite vaiko sėdynės atgręžtos nugarą į priekinį automobilio stiklą ten, kur yra veikiant keleivio oro pagalvė.
S	KAN VARA LIVSHOTANDE ELLER LEDA TILL ALLVARLIGA SKADOR. Placera aldrig en bakåtvänd barnstol i framsätet då passagerarsidans krockkudde är aktiv.
H	HALÁSOS VAGY SÚLYOS BALESET KÖVETKEZHET BE. Ne helyezzük a gyermekülést a menetiránnyal szembe, ha az utas oldalán légszák működik.
LV	VAR IZRAISĪT NĀVI VAI NOPIETNAS TRAUMAS. Nenovietot mazuļa sēdekli pretēji braukšanas virzienam, ja pasažiera pusē ir uzstādīts gaisa spilvens.
CZ	HROZÍ NEBEZPEČÍ VÁŽNĚHO UBLIŽENÍ NA ZDRAVÍ NEBO DOKONCE SMRTI. Neumísťujte detskú sedačku do opačné polohy vúči smeru jazdy v prípade aktívneho airbagu spolujazdca.
SLO	LAHKO PRIDE DO SMRTI ALI HUDIH POŠKODB. Otroškega avtomobilskega sedeža ne nameščajte v obratni smeri vožnje, če ima vozilo vgrajene zračne blazine za potnike.
RO	SE POATE PRODUCÉ DECESUL SAU LEZIUNI GRAVE. Nu aşezaţi scaunul de maşină pentru bebeluşi în poziţie contrară direcţiei de mers atunci când airbag-ul pasagerului este activat.
GR	ΜΠΟΡΕΙ ΝΑ ΠΡΟΚΛΗΘΟΥΝ ΘΑΝΑΤΟΣ Ή ΣΟΒΑΡΑ ΤΡΑΥΜΑΤΑ. Μην τοποθετείτε το καρεκλάκι αυτοκινήτου για παιδιά σε αντίθετη προς την φορά πορείας θέση σε περίπτωση που υπάρχει αερόσακος εν ενεργεία στη θέση συντεβάρτη.
BG	ИМА ОПАСНОСТ ОТ СМЪРТ И СЕРИОЗНИ НАРАНЯВАНИЯ. Не поставяйте столчето за пренасяне на бебета в положение обратно на посоката на движение, при положение активно на въздушната възглавница за пътуване.
SK	MŮŽE NASTAŤ SMŤ ALEBO VÁŽNE ZRANENIA. Nedávajte autosedačku pre deti do polohy proti chodu vozidla, keď je aktívny airbag spolujazdca.
RUS	ТРАВМЫ И ЛЕТАЛЬНЫЙ ИСХОД. Детское кресло, устанавливающееся против направления движения, нельзя монтировать на месте переднего пассажира, если последнее оборудовано активной подушкой безопасности.
HR	OPASNOST OD TEŠKIH ILI SMRTONOSNIH OZLJEDA. Sjedala za djecu koja se montiraju u smjeru suprotnom od vožnje ne smiju se instalirati na prednja sjedala ako postoji aktivni zračni jastuk suvozača.
AS	قد تحدث حالات وفاة أو إصابات بالغة. لا تستخدم مقاعد الأمان الخاصة بالأطفال على مقعد مزود "بوسادة هوائية"، حيث إن الطفل قد يتعرض للوفاة أو لإصابة بالغة.

148

JOA025

SIDE BAGS

To help increase occupants protection in the event of side impact collisions, the vehicle is equipped with front side bags and window bags.

Side bag

These comprise two bags located in the front seat backrests fig. 149 which protect the pelvis, chest and shoulder area of the occupants in the event of a side collision of medium-high severity. They are marked by the "AIRBAG" label sewn on the outer side of the front seats.



149

06106V0004EM

Window bag

This consists of a "curtain" bag housed behind the roof side linings and covered by special trims fig. 150.

They are designed to protect the head of front and rear occupants in the event of a side collision, thanks to the wide cushion inflation surface.



150

06106V0005EM

The deployment of side bags in the event of side impacts of low severity is not required.

In the event of a side impact, the system provides best protection if the passenger sits on the seat in a correct position, allowing the window bag to inflate correctly.

 103) 104) 105) 106) 107) 108) 109) 110) 111) 112) 113) 114) 115) 116)

Warnings

Do not wash the seats with water or pressurised steam (wash by hand or at automatic seat washing stations).

The front airbags and/or side bags may be deployed in the event of sharp impacts to the underbody of the car (e.g. impact with steps, pavements, potholes or road bumps etc.).

When the airbag deploys it emits a small amount of dust: the dust is harmless and does not indicate the beginning of a fire.

The dust may irritate the skin and eyes however: in this case, wash with neutral soap and water.

Airbag checking, repair and replacement must be carried out at an Alfa Romeo Dealership.

If the car is scrapped, have the airbag system deactivated at an Alfa Romeo Dealership.

Pretensioners and airbags are deployed in different ways on the basis of the type of collision. Failure to activate one or more of the devices does not indicate a system malfunction.



WARNING

103) Do not apply stickers or other objects on the steering wheel, on the dashboard in the passenger side airbag area, on side upholstery on the roof or on the seats. Never put objects (e.g. mobile phones) on the passenger's side dashboard since they could interfere with correct inflation of the airbag and also cause serious injury to the passengers.

104) Always drive with your hands on the steering wheel rim so that the airbag can inflate freely if necessary. Do not drive with your body bent forward. Keep the back of your seat upright and lean back into it.

105) The passenger airbag can be deactivated on the Connect system by selecting the following functions in sequence on the main menu: "Settings";



ABC



"Safety"; "Passenger air bag" and "Deactivation".

106) Do not affix rigid objects to the garment hooks or support handles.

107) Do not rest your head, arms or elbows on the door, on the windows or in the window bag area to prevent injury during deployment.

108) Never lean your head, arms or elbows out of the window.

109) If when setting the ignition device to ON the warning light  does not turn on or stays on whilst driving, a failure may have occurred in the restraint systems. In this case the air bags or pretensioners may not be deployed in an impact or, in a lower number of cases, they may be deployed accidentally. Before continuing, contact an Alfa Romeo Dealership immediately to have the system checked.

110) In the event of a LED  OFF failure (located on the front courtesy light), the  warning light on the instrument panel turns on.

111) On cars with side bags, do not cover the front seat backrests with extra covers.

112) Do not travel with objects in your lap, in front of your chest or held in your mouth (e.g., pipe, pencil etc.). They could cause severe injury if the airbag is deployed in a crash.

113) If the car has been subject to theft, attempted theft, vandalism, or flooding, have the air bag system inspected at an Alfa Romeo Dealership.

114) Failure of the  warning light is indicated by the activation of a dedicated icon and a dedicated message on the

instrument panel display. The pyrotechnic charges are not disabled. Before continuing, contact an Alfa Romeo Dealership immediately to have the system checked.

115) The front airbag deployment threshold is higher than that of the pretensioners. For impacts whose intensity falls between the two levels, normally, only the pretensioners will be activated.

116) The airbag does not replace seat belts but increases their efficiency. Because front airbags are not deployed for low-speed crashes, side collisions, rear-end shunts or rollovers, occupants are protected, in addition to any side bags, only by their seat belts, which must therefore always be fastened.



We have now reached the "heart" of the car: let's see how to use the car to its full potential. We'll look at how to drive safely in any situation, making it a welcome companion with our comfort and wallets in mind.

STARTING AND DRIVING

STARTING THE ENGINE	136
ENGINE RUN-IN	137
WHEN PARKED	137
AUTOMATIC TRANSMISSION	140
"Alfa DNA™ Pro" SYSTEM	144
ALFA ACTIVE SUSPENSION (AAS)	147
START & STOP EVO	147
SPEED LIMITER	148
CRUISE CONTROL	149
ACTIVE CRUISE CONTROL	151
HAS (Highway Assist) SYSTEM	156
TJA (Traffic Jam Assist) SYSTEM	161
TSR (Traffic Sign Recognition) SYSTEM	165
ISC (Intelligent Speed Control) SYSTEM	167
PARK SENSORS SYSTEM	168
LANE DEPARTURE WARNING (LDW) SYSTEM	171
LANE KEEPING ASSIST (LKA) SYSTEM	174
REAR BACK-UP CAMERA / DYNAMIC GRIDLINES	177
REFUELLING THE CAR	178
AdBlue® (UREA) ADDITIVE FOR DIESEL EMISSIONS	183
DRIVING TIPS	183
TOWING TRAILERS	186

STARTING THE ENGINE

Before starting the engine, adjust the seat, the interior rear-view mirrors, the door mirrors and fasten the seat belt correctly.

Never press the accelerator pedal for starting the engine.

If necessary, messages indicating the starting procedure can be shown on the display.

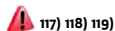

117) 118) 119)

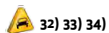

32) 33) 34)

Proceed as follows:

- engage the electric parking brake and set the gear lever to P (Park) mode or N (Neutral),
- fully depress the brake pedal without touching the accelerator;
- briefly press the ignition button;
- if the engine doesn't start within a few seconds, you need to repeat the procedure.
- if the problem persists, contact an Alfa Romeo Dealership.

PROCEDURE FOR DIESEL VERSIONS



35)

Proceed as follows:

- engage the parking brake and set the gear lever to P (Park) or N (Neutral);
- fully depress the brake pedal without touching the accelerator;

- briefly press the ignition button;
- if the engine doesn't start within a few seconds, you need to repeat the procedure.

If the problem persists, contact an Alfa Romeo Dealership.

ENGINE STARTING FAILURE

Starting the engine with electronic key battery (Keyless Start) run down or flat

If the ignition device does not respond when the relevant button is pressed the electronic key battery might be run down or flat. Therefore, the system does not detect the presence of the electronic key on board the car and displays a dedicated message.

In this case, follow the instructions in "Starting with flat key battery" chapter in the "Knowing your car" section and start the engine normally.

SWITCHING OFF THE ENGINE



34)

To stop the engine, proceed as follows:

- park the car in a position that is not dangerous for oncoming traffic;
- engage P (Park) mode;
- with engine idling, press the start button.

Cars with electronic key (Keyless Start)

If the car speed is above 5 mph (8 km/h), it is still possible to stop the engine if a gear operating mode other than P (Park)

is selected. To switch off the engine in this situation, hold down the ignition device button for a while or press it 3 times in a row within a few seconds.



WARNING

117) It is dangerous to run the engine in enclosed areas. The engine consumes oxygen and engine exhaust contains carbon dioxide, carbon monoxide and other toxic gasses.

118) The electro-hydraulic braking system is not active until the engine starts running. So, the brake pedal travel will be longer than normal. This does not indicate a fault.

119) Do not start the engine by pushing, towing or driving downhill. These manoeuvres may damage the catalytic converter.



IMPORTANT

32) We recommend that during the initial period, or during the first 1600 km (1000 miles), you do not drive to full car performance (e.g. excessive acceleration, long journeys at top speed, sharp braking, etc.).

33) With the engine stopped never leave the ignition device in the ON position to prevent useless current draw from draining the battery.

34) A quick burst on the accelerator before turning off the engine serves absolutely

no practical purpose; it wastes fuel and is damaging for the engine.

35) The  symbol will flash after starting or during prolonged cranking to indicate a fault with the glow plug preheating system. If the engine starts, the car can be regularly used, but an Alfa Romeo Dealership must be contacted as soon as possible.

ENGINE RUN-IN

RECOMMENDATIONS FOR RUNNING IN THE ENGINE

(2.0 T4 MAir and 2.9 V6 versions)

Despite modern construction technology, the mechanical parts of the engine must be run in during the first 500 miles (800 kilometres) of travel up to the first engine oil change.

NOTE The consumption of engine oil and fuel in a new engine, during the first thousand kilometres of operation, before the first engine oil change, could be higher than usual. This is normal behaviour during the run-in period and should not be understood as an fault. Periodically check the engine oil level during the run-in period and top up, if necessary, as shown in the "Maintenance and care" section.

Observe following driving behaviour during the run-in period of the car.

From 0 to 100 miles (from 0 to 160 kilometres)

- Do not leave the engine idling for a long time.
- Gradually press the throttle pedal never more than halfway to avoid excessive acceleration.
- Avoid braking too hard.
- Drive keeping the engine under 3500 rpm.
- Keep your speed below 55 mph (90 km/h) and respect the speed limits in force in the country in which you are driving.

From 100 to 300 miles (from 160 to 500 kilometres)

- Gradually press the throttle pedal never more than halfway to avoid rapid acceleration in low gears (from 1st to 3rd).
- Avoid braking too hard.
- Drive keeping the engine under 5,000 rpm.
- Keep your speed below 70 mph (120 km/h) and respect the speed limits in force in the country in which you are driving.

From 300 to 500 miles (from 500 to 800 kilometres)

- Make full use of the full rpm range by manually shifting at higher revs where possible, in sequential mode using the gear lever or steering wheel paddles (where provided).

- Do not hold the throttle pedal pressed, requiring maximum engine performance, for too long.
- Keep your speed below 85 mph (144 km/h) and respect the speed limits in force in the country in which you are driving.

During the first 1500 miles (2500 kilometres):

- Avoid taking part in races on the track.
- Avoid sporty driving or similar activities.

WHEN PARKED

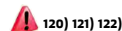

120) 121) 122)

WARNING In addition to parking the vehicle with the parking brake always engaged, the wheels turned, chocks or stones positioned in front of the wheels (when on a steep slope), you must always:

- engage P (Park) mode;
- always take the key with you when leaving the vehicle.

WARNING Always engage the electric parking brake before leaving the car.

ELECTRIC PARKING BRAKE

The car is equipped with electric parking brake to guarantee better use and optimal performance compared to a manually operated parking brake.

The electric parking brake features a switch, located on the central tunnel



ABC

fig. 151, a motor with calliper for each rear wheel and an electronic control module.

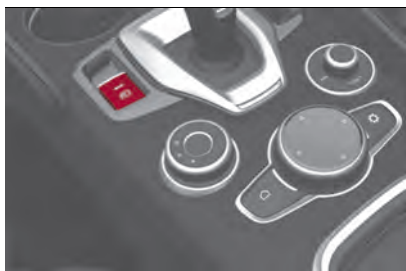

151

0707650996EM

The electric parking brake can be engaged in two ways:

- *manually*, by pulling the switch on the central tunnel;
- *automatically* in "Safe Hold" or "Auto Park Brake" conditions.

WARNING Normally, the electric parking brake is engaged automatically when the engine is stopped. This function can be deactivated/activated on the Connect system by selecting the following items in sequence on the main menu: "Settings", "Driver Assistance" and "Automatic Parking Brake".

WARNING Should the car battery be faulty, to unlock the electric parking brake the battery must be replaced.

Engaging the parking brake manually

Briefly pull the switch located on the central tunnel fig. 151 to manually engage

the electric parking brake when the car is stationary.

Noise may be heard from the rear of the car when engaging the electric parking brake.

A slight movement of the brake pedal may be detected when engaging the electric parking brake with the brake pedal pressed.

With the electric parking brake engaged, the  warning light on the instrument panel and the LED on the switch fig. 151 turn on.

WARNING With the Electronic Parking Brake failure warning light on, some functions of the electric parking brake are deactivated. In this case the driver is responsible for brake activation and car parking in complete safety conditions.

If, under exceptional circumstances, the use of the brake is required with the car in motion, keep the switch on the central tunnel pulled as long as the brake action is necessary.

The warning light  may switch on with the hydraulic system temporarily unavailable; in this case braking is controlled by the motors.

The brake lights (stop) will also automatically switch on in the same way as for normal braking with the use of the brake pedal.

Release the switch on the central tunnel to stop the braking action with the car in motion.

If, through this procedure, the vehicle is braked until a speed below 2 mph (3 km/h) is reached and the switch is kept pulled, the parking brake will definitively engage.

WARNING Driving the car with the electric parking brake engaged, or using it several times to slow down the car, may cause severe damage to the braking system.

Disengaging the electric parking brake manually

In order to manually release the parking brake, the ignition device should be at ON position.

Moreover, you need to press the brake pedal, then press the switch on the central tunnel briefly.

Noise may be heard from the rear of the vehicle and a slight movement of the brake pedal may be detected during disengagement.

After disengaging the electric parking brake, the  warning light on the instrument panel and the LED on the switch fig. 151 turn off.

If the  warning light on the instrument panel remains on with the electric parking brake disengaged, this indicates

a fault: in this case contact an Alfa Romeo Dealership.

WARNING Never use gear position P (Park) instead of the electric parking brake. When parking the car, always apply the electric parking brake to prevent injury or damage caused by uncontrolled movement of the car.

ELECTRIC PARKING BRAKE OPERATING MODES

The electric parking brake may operate as follows:

- *"Dynamic operating mode"*: this mode is activated by pulling the switch repeatedly whilst driving;
- *"Static engagement and release mode"*: with the car stationary, the electric parking brake can be activated by pulling the switch on the central tunnel once. On the other hand, press the switch and the brake pedal at the same time to disengage the brake;
- *"Drive Away Release"*: (where provided) the electric parking brake will automatically disengage with the driver side seat belt fastened and the detection of an action performed by the driver to move the car (forward gear or reverse gear);

NOTE If the vehicle is equipped with carbon-ceramic discs, before using "Drive Away Release" mode and moving the vehicle, it is necessary to buckle

the seat belts or manually release the electric handbrake to prevent damage to the carbon-ceramic discs themselves.

- *"Safe Hold"*: if the vehicle speed is lower than 2 mph (3 km/h), the gear lever is not in P (Park) position and the driver's intention of leaving the vehicle is detected, the electric parking brake will automatically engage to hold the vehicle in safety conditions;
- *"Auto Park Brake"*: if the vehicle speed is below 2 mph (3 km/h), the electric parking brake will automatically engage when the gear lever is in P (Park) position. The LED on the switch located on the central tunnel fig. 151 switches on together with the warning light (ⓘ) on the instrument panel when the parking brake is engaged and applied to the wheels. Each automatic parking brake engagement can be cancelled by pressing the switch on the central tunnel and at the same time moving the gear lever for the transmission to position P (Park).

SAFE HOLD

It is a safety function that automatically engages the electric parking brake in the event of a dangerous condition for the car.

If:

- the car speed is below 2 mph (3 km/h);
- a transmission operating mode

different from P (Park) is activated;

- the driver's seat belt is not fastened;
- the driver side door is open;
- no attempts to apply pressure on the brake pedal have been detected;
- the car is parked on roads which gradient higher than 4%;

the electric parking brake engages automatically to prevent car movement. The Safe Hold function can be temporarily disabled by pressing the switch located on the central tunnel and the brake pedal at the same time, with the car stationary and the driver side door open.

Once disabled, the function will activate again when the vehicle speed reaches 12 mph (20 km/h) or the ignition device is moved to STOP and then to ON.



WARNING

120) *In the case of parking manoeuvres on roads on a gradient, the front wheels must be steered towards the pavement (when parking downhill), or in the opposite direction if the car is parked uphill. Block the wheels with a wedge or a stone if the car is parked on a steep slope.*

121) *Never leave children unattended in the car. Always remove the key from the ignition*



ABC

device when leaving the car and take it with you.

122) The electric parking brake must always be engaged when leaving the car.

AUTOMATIC TRANSMISSION

DISPLAY

The following information is shown on the dedicated area of the instrument panel display fig. 152:

□ **in automatic mode:** the active mode (P, R, N, D). In D (Drive) mode, when changing gear using the steering wheel lever (where provided), it also shows the gear engaged with a number;

□ **in manual drive mode (sequential):** the mode (M), the current gear and the gear shift request, both up and down (arrow).



152

9490105

GEAR LEVER



The transmission is operated by means of the control lever (1) fig. 153 which can be used to select the following operating modes:

- **P** = Park
- **R** = Reverse
- **N** = Neutral
- **D** = Drive, (automatic forward speed)
- **AutoStick:** + shifting to higher gear in sequential driving mode / - shifting to lower gear in sequential driving mode.

The positions diagram is illustrated on the top of the lever.

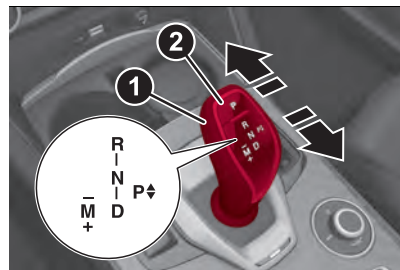

153

07076V0686EM

The letter corresponding to the selected mode lights up and can be seen on the instrument panel display.

To select one of the operating modes, move the lever forwards or backwards and press the brake pedal at the same time.

To engage R (Reverse) mode, press the pedal and the button (3) fig. 154 in combination.

To pass from P (Park) mode directly to D (Drive) mode, in addition to pressing the brake pedal, it is also necessary to press button (3).

To pass from R (Reverse) mode directly to D (Drive) mode and vice versa, in addition to pressing the brake pedal, it is necessary to press button (3).



154

07076V0020EM

The lever functions like a joystick, so releasing it after giving the command, it automatically returns to the centre position.

The P (Park) mode can be enabled pressing the P (Park) (2) fig. 153 button. If using the gear shift in "sequential" mode, you can activate it by moving the lever from D (Drive) to the left and then forward towards the - symbol or back

towards the + symbol and the gear is shifted.

To exit position P (Park), or to pass from position N (Neutral) to position D (Drive) or R (Reverse) when the car is stopped or is moving at a low speed, the brake pedal must also be pressed.

WARNING DO NOT accelerate while shifting from position P (or N) to another position.

WARNING After selecting a gear, wait a few seconds before accelerating. This precaution is particularly important with engine cold.

TRANSMISSION OPERATING MODES

Park (P)



The transmission is locked in this mode. The engine can be started in this mode.

WARNING Never try to engage the P mode (Park) when the car is moving. Before leaving the car, make sure this mode is engaged (letter P shown on the display) and that the parking brake is engaged.

When parking on a flat surface, first engage the P mode and then engage the parking brake.

Parking uphill, before activating the P mode, engage the parking brake,

otherwise it could be difficult to engage the P mode.

To check that the P mode (Park) is actually engaged, make sure P is illuminated on the display.

It is not possible to select N (Neutral) mode from P (Park) mode.

Automatic activation of P (Park) mode

P (Park) mode is automatically activated if the following conditions are met simultaneously:

- D (Drive) or R (Reverse) mode is active;
- the car's speed is close to 0;
- the brake pedal is released;
- the driver's seat belt is not fastened;
- the driver's door is open.

Reverse (R)

Select this mode only with the car at a standstill.



Neutral (N)



It corresponds to neutral for a manual transmission. The engine can be started with the N mode (neutral) selected.

Engage the N mode in the case of prolonged stops with engine running. Also engage the electric parking brake.

Drive (D) - Automatic forward gear

Use this mode in normal driving conditions.

Passage from D to P (Park) or R (Reverse) modes must take place only after releasing the accelerator pedal, with car at a standstill and brake pedal pressed.

This mode ensures automatic engagement of the most suitable gears for driving needs and maximum fuel economy in terms of consumption.

In this position, the transmission shifts the gears automatically, selecting the most suitable for forward driving among those available as you go. In this way the car's optimal driving characteristics are guaranteed in all the classic usage conditions.

AutoStick - Manual (sequential) shifting mode

In the case of frequent gearshifting (e.g. for sport driving, when the car is driven with a heavy load, on slopes, with strong headwind or when towing heavy trailers), it is recommended to use the Autostick (sequential shifting) mode to select and keep a lower fixed ratio.

In these conditions, the use of a lower gear improves car performance, preventing overheating.



ABC

It is possible to shift from D mode (Drive) to sequential mode regardless of car speed.

Activation

Starting from D (Drive) mode, to activate the sequential drive mode, move the lever to the left (- and + indication of the trim). The gear engaged will be shown on the display.

Gearshifting is made by moving the gear lever forwards, towards symbol - or backwards, towards symbol +.

Steering wheel stalks

(where provided)

The gear can be manually shifted also by using the levers behind the steering wheel, pull the right gear lever (+) towards the steering wheel and release it to engage a higher gear; perform the same operation with the left lever (-) to engage a lower gear fig. 155.

To engage N (Neutral): pull simultaneously both levers.

To activate D (Drive) mode, from N (Neutral), P (Parking) and R (Reverse): push the brake pedal and the right lever (+).



155

9550205

WARNING If only one manual shift is necessary, the letter D will remain on the display with the engaged gear next to it.

Deactivation

To deactivate the sequential driving mode, bring the gear lever back in position D (Drive) ("automatic" driving mode).

Warnings

- ❑ Do not downshift on slippery surfaces: the drive wheels might lose grip with following risk for the car to slip. This could cause accidents or personal injuries.
- ❑ To select the correct gear for maximum deceleration (engine brake), just keep the gear lever pressed forwards (-): the transmission goes to an operating mode in which the car can slow down easily.

- ❑ The car will keep the gear selected by the driver until the safety conditions allow it.
- ❑ This means, for example, that the system will try to prevent the engine from switching off, automatically downshifting if the engine speed is too low.

TRANSMISSION EMERGENCY FUNCTION

(where provided)

Transmission function is monitored electronically for abnormal conditions. If a condition that might damage the transmission is detected, the "transmission emergency" function is activated.

In this condition, the transmission stays in 4th gear, regardless of the selected gear. The P (Park), R (Reverse) and N (Neutral) modes continue to work.

The symbol might light up in the display .

In the event of a "transmission emergency" immediately contact the nearest Alfa Romeo Dealership.

Temporary failure

If the symbol  appears, the failure may be temporary, in which case, proceed as follows to restore correct transmission operation:

- ❑ stop the car;

- ❑ engage P (Park) mode;
 - ❑ turn the ignition device to the STOP position;
 - ❑ wait for about 10 seconds, then restart the engine;
 - ❑ shift into the desired gear range.
- If the problem is no longer detected, the transmission will return to normal operation.

WARNING In the event of a temporary failure it is in any case recommended to contact an Alfa Romeo Dealership as soon as possible.

GEAR ENGAGEMENT DISABLING SYSTEM WITHOUT BRAKE PEDAL PRESSED

This system prevents you from moving the gear lever from P (Park) mode if the brake pedal has not been previously depressed.

To bring the gear lever to a position other than P (Park), the ignition device must be in position AVV (engine on) and the brake pedal must be pressed.

PARK ENGAGEMENT DISABLING WHEN ENGINE IS STOPPED

Only if strictly necessary (e.g. pushing the car, conveyor car washing systems) inhibit the automatic activation of P mode (Park) when stopping the engine, or proceed as described below:

- ❑ car at a standstill;
- ❑ N (neutral) mode activated;
- ❑ press the ignition button for at least 3 seconds.

The automatic parking brake engagement function when the engine is stopped can also be deactivated on the Connect system by selecting the following functions on the main menu: "Settings", "Driver Assistance" and "Automatic Parking Brake".

GENERAL WARNINGS

Failure to comply with what is reported below may damage the transmission:

- ❑ select P mode (Park) only with the car at a standstill;
- ❑ select R mode (Reverse), or pass from R to another mode only with the car at a standstill and engine idling;
- ❑ do not change between P (Park), R (Reverse), N (Neutral) or D (Drive) modes with engine running at a speed above idling;
- ❑ before activating any transmission operating mode, fully depress the brake pedal.

WARNING The unexpected movement of the car can injure the occupants or people nearby. Do not leave the car with engine running: before getting out of the passenger compartment always engage the electric parking brake, select the P mode (Park), stop the engine.

With the ignition device in the STOP position, the transmission is blocked in the P position (Park), to prevent accidental car movement; on versions equipped with Keyless Start, do not leave the electronic key near the car (or in a place accessible to children) and do not leave the ignition device activated.

A child could activate the electric window winders, other controls or even start the engine; it is dangerous to select a mode other than P (Park) or N (Neutral) at an engine speed higher than idling.

If the brake pedal is not fully depressed the car could rapidly accelerate.

Only engage the gear with engine at idling, fully depressing the brake pedal; if the transmission temperature exceeds the normal operating limits, the transmission control module may change the gear engagement order and reduce the drive torque; if the transmission overheats the display shows the  symbol. In this case the transmission could operate incorrectly until it cools down; when using the car with extremely low external temperatures, the transmission operation may change depending on the engine and transmission temperature, as well as car speed; activation of the torque converter clutch and of the 7th or 8th gear is inhibited until the transmission oil is correctly warmed up. Complete



ABC

operation of the transmission will be enabled as soon as the fluid temperature reaches the predefined value.



WARNING

123) Never use position P (Park) instead of the electric parking brake. Always engage the electric parking brake when parking the vehicle to avoid the accidental movement of the vehicle.

124) If the P (Park) position is not engaged, the car could move and injure people. Before leaving the car, make sure that the gear lever is in position P and that the electric parking brake is engaged.

125) Do not shift the gear lever to N (Neutral) and do not stop the engine when driving on a downhill road. This type of driving is dangerous and reduces the possibility of intervening in the case of variation of the road traffic or surface. You risk losing control of your car and causing accidents.



IMPORTANT

36) There must be no objects (such as bracelets for example) near or around the gear lever, nor objects that protrude from the glove compartment in front of the gear lever, as they could interfere and obstruct its movement, even if only temporarily.

37) Before selecting P (Park) mode, bring the ignition device to position ON and press

the brake pedal. Otherwise, the gear lever may get damaged.

38) Engage reverse only with the car stationary, engine at idling speed and accelerator fully released.

“Alfa DNA™ Pro” SYSTEM

DESCRIPTION

This device allows different car response modes to be selected according to driving style and road conditions using the selector fig. 156 (on the central tunnel).



156

04026V0997EM

- **d** = Dynamic (sports driving mode)
- **n** = Natural (mode for driving in normal conditions)
- **a** = Advanced Efficiency (ECO driving mode for maximum fuel savings)
- **RACE** (where provided) = track race driving mode

□  (where provided) = changes the suspension setting

On some versions when the engine is stopped, the selector always returns to **n** (Natural) mode.

With Race mode active (yellow text on the instrument panel display), the selector is lit up red.

The different driving modes are represented on the instrument panel display as shown in fig. 157.

The different driving modes can also be recognised by the content of the "performance" screens.



157

9550516

Coasting function

(2.0 T4 MAir and 2.2 JTD versions)

The car has a "coasting" function, which is available in driving modes "a" (Advanced Efficiency) and "n" (Natural), and provides fuel savings.

The function is automatically activated by the driver when the accelerator is

released below a certain vehicle speed, without simultaneously pressing the brake pedal.

The coasting function is active when the accelerator pedal is released only if the speed is below 150 km/h.

In this condition, the engine returns to its idle state and the car decelerates without the engine applying resistance to the wheels. The engine is reconnected to the transmission system the next time the accelerator pedal is pressed.

DRIVING MODES **"Dynamic" Mode** **Activation**

It is activated by rotating the selector to the letter "d". With the instrument cluster in "Evolved" mode, the speedometer and tachometer gauges are red.

ESC and ASR systems: intervention thresholds that ensure more enjoyable, sportier driving whilst guaranteeing the stability of the car.

"Electronic Q2" system: the system is calibrated to increase traction whilst accelerating on bends, improving the agility of the car.

Engine and gearbox/transmission: adoption of sports mapping.

WARNING In "Dynamic" mode, the sensitivity of the accelerator pedal increases considerably. Consequently, driving is less fluid and comfortable. The

"Performance" screen displays parameters related to car stability, the graphs illustrate the trend of the longitudinal/lateral accelerations (G-meter information), considering gravity acceleration as a reference unit.

Lateral acceleration peaks are displayed on the right fig. 158.



Deactivation

To deactivate the Dynamic mode, move the selector to Natural mode ("n").

"Natural" mode **Activation**

It is activated by rotating the selector to the letter "n". With the instrument cluster in "Evolved" mode, the speedometer and tachometer gauges are white.

Engine and gearbox/transmission: standard response.

The "Performance" screen shows the average and instantaneous fuel consumption fig. 159.



Deactivation

To deactivate the Natural mode, move the selector to another mode ("d" or "a").

"Advanced Efficiency" Mode **Activation**

It is activated by rotating the selector to the letter "a".

ESC and ASR systems: intervention thresholds aimed at ensuring maximum safety in low-grip driving conditions. It is advisable to select "Advanced Efficiency" mode in the presence of low-grip road surfaces.

"Electronic Q2" system: the system is deactivated.

Reduced engine performance.

ECO shifting strategy for the automatic transmission.



ABC

The "Performance" screen shows the average and instantaneous fuel consumption fig. 159.

Deactivation

To deactivate the Advanced Efficiency mode, move the selector to Natural mode ("n").

WARNINGS

- The selector will always be in the Natural mode ("n") position when the engine is started.
- When the engine is next started, the "Race" mode selected previously is not retained. The system will reactivate in "Dynamic" mode.

"Race" mode

(where provided)

Activation

It is activated by turning the selector to the "Race" position: the following screen appears in the central area of the tachometer display, fig. 160.

Engine and gearbox/transmission: adoption of sports mapping.

WARNING This mode should be activated on race tracks.

WARNING In "Race" mode, the sensitivity of the accelerator pedal increases considerably. Consequently, driving is less fluid and comfortable.



160

9550182

The graphic bar for the GSI (Gear Shift Indicator) system consists of three segments (1) fig. 161: on reaching the last one, the system advises the driver to shift gear fig. 162.

NOTE With the automatic transmission in "automatic" mode, the graphic bars and GSI (Gear Shift Indicator) system information will not appear on the display, and the car speed will be shown at the bottom.

The screen displays the lateral and longitudinal acceleration peaks.

The "Performance" screen displays parameters related to car stability, the graphs illustrate the trend of the longitudinal/lateral accelerations (G-meter information), considering gravity acceleration as a reference unit.



161

9550505



162

9550171

WARNING When the braking system has overheated, the Connect system displays this condition. In this case, let the system cool down for a few minutes by driving the car normally without operating the brakes.

Deactivation

To disable Race mode, move the selector to the "RACE" position again: the system will activate "d" (Dynamic) mode.

ALFA ACTIVE SUSPENSION (AAS)

(where provided)

The electronic suspensions control system of the car is the result of a sophisticated elaboration of the various board sensors, aimed at optimising the performance of the car.

The system continuously monitors the damping of the suspensions through the actuator installed on each shock absorber. This way, the calibration of the shock absorbers can be adjusted to the conditions of the road surface and to the dynamic conditions of the vehicle, improving its comfort and road holding.

The driver can choose, even while driving, (only in "d" or "Race" mode), between two types of suspension calibration: a more sporty or a more comfortable one.



163

04026V0957EM

By pressing the button fig. 163, the system prepares to work with a shock

absorber calibration which favours driving comfort.

In the case of a system failure, the following symbol appears on the instrument panel display .

START & STOP EVO

The Stop/Start Evo automatically stops the engine each time the car is stationary and starts it again when the driver wants to move off.

In this way, the car efficiency is increased, by reducing consumption, emission of harmful gases and noise pollution.

OPERATING MODE

Stopping the engine

With car at a standstill and brake pedal pressed, the engine switches off if the gear lever is in a position other than R.

The system does not operate when the gear lever is in R, for making parking manoeuvres easier.

In the event of stops uphill, engine switching off is disabled to make the "Hill Start Assist" function available (works only with running engine).

NOTE The engine can only be automatically stopped after having run at about 6 mph (10 km/h). After an automatic restart, to stop the engine you only need to move the car (exceed a speed of 0.3 mph - 0.5 km/h).

Engine stopping is signalled by the  symbol lighting up on the instrument panel display.

Restarting the engine

To restart the engine, release the brake pedal or, for versions/markets where provided, turn the steering wheel slightly. With the brake pressed and the transmission in automatic mode D (Drive), the engine will restart by shifting to R (Reverse), for petrol engine versions only, to "AutoStick".

With brake pressed, also for versions with petrol engines, if the gear lever is in "AutoStick" mode, the engine can be restarted by moving the lever to + or -.

SYSTEM MANUAL ACTIVATION / DEACTIVATION

 126)

 39)

To manually activate/deactivate the system, press the button inserted in the control panel on the left of the steering wheel, fig. 164.

- LED off:** system activated
- LED on:** system deactivated



ABC



164

9490199

SAFETY FUNCTIONS

When the engine is stopped through the Start&Stop Evo system, if the driver releases their seat belt, opens the driver's or passenger's door or releases the engine bonnet from inside the car, the engine can be restarted only by using the ignition device.

This condition is indicated to the driver both through a buzzer and a message on the instrument panel display.



WARNING

126) When replacing the battery, always contact an Alfa Romeo Dealership. Replace the battery with a new one of the same EFB (Enhanced Flooded Battery) type and specifications.



IMPORTANT

39) If climate comfort is to be favoured, the Start&Stop system can be deactivated, for a continuous operation of the climate control system.

SPEED LIMITER

This device allows the speed of the car to be limited to values which can be set by the driver.

The maximum speed can be set both with car stationary and in motion. The minimum speed that can be set is 20 mph (30 km/h).

When the device is active, the car speed depends on the pressure at the accelerator pedal, until the set speed limit is reached.

ACTIVATING THE DEVICE

The function can be activated/deactivated on the Connect system.

Activating the device

To access the function, select the "Driver Assistance" widget on the Connect system display and select the "Comfort" menu.

The activation of the device is signalled by the displaying of the green symbol along with the last speed set.

SPEED LIMIT PROGRAMMING

To access the function, on the main menu select the following items in sequence: "Settings", "Safety" and "Speed Limiter - Set Speed".

By turning the Rotary Pad, the speed increases by 5 mph (5 km/h), on rotation, from a minimum of 20 mph (30 km/h) to a maximum of 110 mph (180 km/h).

DEACTIVATING THE DEVICE

Deactivating the device

To access the function, on the main menu select the following items in sequence: "Settings", "Safety", "Speed Limiter" and "Off".

Automatic off of the device

The device deactivates automatically in the event of fault in the system. In this case, contact an Alfa Romeo Dealership.

CRUISE CONTROL

This is an electronically controlled driving assistance device that allows the desired car speed to be maintained, without having to press the accelerator pedal. This device can be used at a speed above 20 mph (30 km/h) on long stretches of dry, straight roads with few variations (e.g. motorways).

It is therefore not recommended to use this device on extra-urban roads with traffic. Do not use the device in town.

The Cruise Control buttons are located on the left side of the steering wheel.

To ensure correct operation, the Cruise Control is designed to deactivate if more than one function is operated simultaneously. In this case the system can be reactivated by pressing the  / **CANC** button and setting the desired speed.

Travelling downhill, the system could brake the car to keep the set speed unvaried.

ACTIVATING THE DEVICE

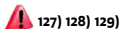

127) 128) 129)

To activate the device press button fig. 165.

The white symbol  on the instrument panel display fig. 166 switches on to signal that the device is on.

The Cruise Control function can remain active concurrently with the Speed Limiter system. If a speed limit below the one indicated in the Cruise Control is selected, the Cruise Control speed will be lowered to that of the Speed Limiter.



165

07146V0030EM

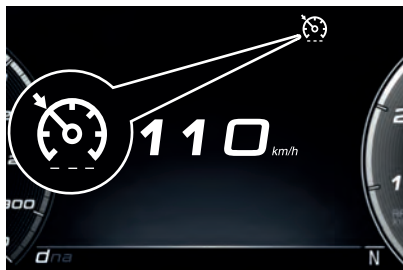

166

9550223

The device cannot be engaged in 1st or reverse gear: it is advisable to engage it in 3rd gear or higher.

WARNING It is dangerous to leave the device on when it is not used. There is a risk of inadvertently activating it

and losing control of the car due to unexpected excessive speed.

SETTING THE DESIRED SPEED

Proceed as follows:

- operate the device (see the previous instructions);
- when the car has reached the desired speed, raise/lower the SET lever fig. 167 and release it to activate the device. When the accelerator is released, the car will maintain the selected speed automatically.

If needed (when overtaking for instance), you can accelerate simply by pressing the accelerator; when you release the pedal, the car goes back to the speed stored previously.

When travelling downhill with the device active, the car speed may slightly exceed the stored one.

WARNING Before raising/lowering the SET lever, the car must be travelling at a constant speed on a flat surface.



167

07146V0031EM



ABC

INCREASING / DECREASING SPEED

Increasing speed

Once the Cruise Control has been activated, the speed can be increased by lifting the SET lever.

Keeping the button pressed, the set speed will increase until the button is released, then the new speed will be stored.

Each single movement of the SET lever will make a fine adjustment to the set speed.

Decreasing speed

When the device is active, lower the SET lever to reduce the speed.

Holding the lever raised/lowered, the set speed will increase until the lever is released, then the new speed will be stored.

Each single movement of the SET lever will make a fine adjustment to the set speed.

WARNING Moving the SET lever adjusts the speed according to the selected unit of measurement ("metric" or "imperial") set on the Connect system (see dedicated supplement).

Accelerating when overtaking

Depress the accelerator pedal: when this is released the car will gradually go back to the stored speed.

Use of the device on hilly routes

In versions equipped with automatic transmission, the device can autonomously downshift to keep the set speed when driving on hilly routes.

On steep gradients, the loss or gain in speed may be considerable and it is therefore preferable to deactivate the device.

WARNING The device keeps the speed stored even uphill and downhill. A slight variation in the speed on slight rises is completely normal.

RECALLING THE SPEED

With automatic transmission operating in D mode (Drive - automatic), press and release the RES fig. 168 button to recall the previously set speed.

With an automatic transmission in Autostick (sequential) mode, before recalling the previously set speed you should accelerate to get close to it, then press and release the RES button.



168

07146V0032EM

DEACTIVATING THE DEVICE

Lightly pressing the brake pedal deactivates the Cruise Control without deleting the stored speed.

The Cruise Control may be deactivated also by applying the electric parking brake or when the braking system is operated (e.g. operation of the ESC system).

The stored speed is deleted in the following cases:

- pressing the on/off button or switching off the engine;
- if there is a malfunction in the Cruise Control.

DEACTIVATING THE DEVICE

The Cruise Control is deactivated by pressing the system on/off button or by putting the ignition device in the STOP position.



WARNING

127) While driving with the device active, never move the gear lever to neutral.

128) In case of a malfunction or failure of the device, contact an Alfa Romeo Dealership.

129) The Cruise Control can be dangerous if the system cannot keep a constant speed. In specific conditions speed may be excessive, resulting in the risk of losing control of the car and causing accidents. Do not use the

device in heavy traffic or on winding, icy, snowy or slippery roads.

ACTIVE CRUISE CONTROL

(where provided)

 130) 131) 132) 133) 134) 135)

 40) 41) 42) 43) 44) 45) 46)

The Active Cruise Control (ACC) is a driver assist device which combines the Cruise Control functions with one for controlling the distance from the vehicle ahead.

The device allows to hold the car at the desired speed without needing to press the accelerator. It also allows to hold a given distance from the vehicle ahead (the distance can be set by the driver).

The Active Cruise Control (ACC) uses a radar sensor, located behind the front bumper fig. 169 and a camera, located in the middle area of the windscreen fig. 170, to detect the presence of a vehicle close ahead.



169

06016V0003EM



170

06016V0004EM



171

07146V0050EM

Important notes

If the sensor does not detect any vehicle ahead, the device will maintain a fixed set speed.

If the sensor detects a vehicle ahead, the device automatically intervenes by braking (or accelerating) slightly in order not to exceed the original set speed, so that the car keeps the preset distance, seeking to adapt to the speed of the vehicle ahead.

In the cases described below, the system performance is not guaranteed, it is therefore advisable to turn the device on by pressing the  / **CANCF** fig. 171 button:

- driving in fog, heavy rain, snow, heavy traffic and in complex driving situations (e.g. on motorways with roadworks in progress);
- driving close to a bend (winding roads), icy, snowy, slippery roads or with a steep uphill or downhill slope;
- entering a turn lane or an off-ramp of the motorway;
- towing a trailer;
- when circumstances do not allow safe driving at a constant speed.

ACTIVATION / DEACTIVATION

The device may have four operating states:

- Enabled (speed not programmed);



ABC

- Activated (speed programmed);
- Paused;
- Deactivated.

Enabling / Activation



Activation

To turn on the device, press and release the  / **CANC** fig. 171 button.

With the device enabled and ready for operation, the display on the instrument panel shows the white icon with dashes in place of the speed.

Activation

Setting a speed activates the system. The displays shows the green icon with the set speed.

The device cannot be enabled when "Race" mode is active.



172

9490499

Pausing / Deactivating

Pause

With the device activated (speed set), press the  / **CANC** button to Pause; the white icon appears on the display with the speed value shown in brackets, fig. 173.

Deactivation

Press the  / **CANC** button again to deactivate the device completely.



173

9490222

SETTING THE DESIRED SPEED

Speeds from 30 km/h (or 19 mph if the unit set by the driver is "mph") to 180 km/h (or 110 mph if the unit set by the driver is "mph") can be set.

when the car reaches the desired speed, raise/lower the RES/SET lever fig. 174 and release it to activate the device. When the accelerator is released, the car will maintain the selected speed automatically.



174

07146V0051EM

Holding the accelerator pressed the device will not be able to control the distance between the car and the one ahead. In this case the speed will be determined only by the position of the accelerator pedal.

The device will return to normal operation as soon as the accelerator pedal is released.

The system **cannot** be activated:

- when pressing the brake pedal;
- when the brakes are overheated;
- when the electric parking brake is engaged;
- when it is in P (Park), R (reverse) or N (neutral) mode;
- when the engine speed is above a maximum threshold;
- when the car speed is not within the settable speed range;

- ❑ when an intervention of the ESC system (or ABS or other stability control systems) is in progress, or has just ended;
 - ❑ during automatic braking by the Forward Collision Warning system (where provided);
 - ❑ in the event of device failure;
 - ❑ when the engine is off;
 - ❑ in case of obstruction of the radar sensor (in this case the bumper area where it is located must be cleaned).
- In case of system set, the conditions described above also cause a cancellation or deactivation of the system with times that may vary according to the conditions.

WARNING The device does not deactivate on reaching speeds higher than those that can be set (180 km/h or 110 mph if the unit set by the driver is "mph") with the accelerator pedal pressed. In these conditions, the device may not work correctly and it is advisable to deactivate it.

CHANGING THE SPEED

Increasing speed

Once the device has been activated, the speed can be increased by lifting the SET lever. Each time it is operated, the speed increases by 1 mph (1 km/h).

By moving the RES/SET lever beyond the first resistance point, the set speed will increase in steps of 6 mph (10 km/h) until

it is released, then the new speed will be stored.

Decreasing speed

Once the device has been activated, it is possible to decrease the speed by lowering the RES/SET lever. Each time it is operated, the speed decreases by 1 mph (1 km/h).

By moving the RES/SET lever beyond the first resistance point, the set speed will decrease in steps of 6 mph (10 km/h) until it is released, then the new speed will be stored.

Important notes

By keeping the accelerator pedal depressed, the car can continue to accelerate beyond the set speed. In this case, lower the RES/SET lever to set the speed to the current car speed.

When using the RES/SET lever to reduce the speed, the braking system intervenes automatically within the limits of the system if engine braking does not slow the car down sufficiently to reach the set speed. The device holds the set speed uphill and downhill; however a slight variation is entirely normal, particularly on slight gradients.

The automatic transmission could change to a lower gears when driving downhill or when accelerating. This is normal and necessary to maintain the set speed.

The device is switched off while driving if the brakes overheat.

ACCELERATING WHEN OVERTAKING



When driving with the device active and following a vehicle, the device provides additional acceleration to facilitate overtaking, when travelling over a given speed and switches on the left direction indicator (of the right indicator for right-hand drive versions).

In left-hand traffic, the overtaking assist function is only active when the left-hand lane is used for overtaking the vehicle ahead (the opposite activation logic is used in right-hand traffic countries).

RECALLING THE SPEED

Once the system has been cancelled but not deactivated, and a speed was previously set, simply move the RES/SET lever up and lift your foot off the accelerator to recall it.

The system will be set to the last stored speed.

WARNING The recall function must only be used if the road and traffic conditions so allow. Recalling an excessively high or low speed for the current traffic and road conditions could cause an acceleration or a deceleration of the car. Failure to comply with these precautions



ABC

may cause serious accidents and fatal injuries.

SETTING THE DISTANCE BETWEEN CARS

 138) 139) 140) 141)

The distance between your car and the vehicle ahead may be set to 1 bar (short), 2 bars (medium), 3 bars (long), 4 bars (maximum) fig. 175.



175

9490498

The distances from the vehicle ahead are proportional to speed.

The setting is 4 (maximum) the first time the device is used. After the distance has been modified by the driver, the new distance will be stored also after the system is deactivated and reactivated.

To decrease the distance

Press and release the button to decrease the distance setting fig. 176. The distance setting decreases by one bar (shorter) every time the button is pressed.



176

07146V0052EM

The set speed is held if there are no cars ahead. Once the shortest distance has been reached, a further press of the button will set the longest distance.

The car holds the set distance until:

- the vehicle ahead accelerates to a speed higher than the set speed;
- the vehicle ahead leaves the lane or the detection field of the Active Cruise Control sensor;
- the distance setting is changed;
- Active Cruise Control is deactivated/paused.

DEACTIVATION

The device is deactivated and the set speed is cancelled if:

- the  / **CANC** button on the Active Cruise Control is pressed (with the device on or paused);
- the ignition device switch is in the STOP position;

- "Race" mode is activated.

The device is cancelled (the set speed and distance are stored):

- when the device is paused (see the "Active Cruise Control Activation / Deactivation" paragraph);
- when the conditions shown in the "Setting the desired speed" paragraph occur.

PRECAUTIONS WHILE DRIVING

The device may not work correctly in some driving conditions (see below): the driver must control the car at all times.

Towing a trailer

Use of the device is not recommended while towing a trailer.

Vehicle not aligned

The device may not detect a car travelling on the same lane but which is not aligned along the same direction of travel or a car which is cutting in from a side lane. Sufficient distance from the vehicles ahead may not be guaranteed in these cases.

The non-aligned car can weave in and out of the driving direction causing the car to brake or accelerate unexpectedly.

Steering and curves

When cornering with the device set, it could limit speed and acceleration to guarantee car stability even if no vehicles are detected ahead.

When leaving the curve, the device resets the previously set speed.

WARNING In case of narrow curves, the performance of the device could be limited. In this case, it is advisable to deactivate the device.

Moreover, remember that the device only limits the speed **DURING** a bend and not **BEFORE** it, so always take great care.

Using the device on gradient

When driving on roads with variable gradient, the device may not detect the presence of a vehicle on the lane. Device performance could be limited according to speed, load, traffic conditions and gradient steepness.

Lane change

The device may not detect the presence of a vehicle until it is fully in your lane.

In this case, sufficient distance from the vehicle which is changing lane may not be guaranteed: it is advisable to pay the utmost attention at all times and be always ready to press the brakes if needed.

Small vehicles

Some narrow cars (e.g. bicycles and motorcycles) travelling near the outer edges of the lane or which enter the lane from kerbside are not detected until they are fully in the lane.

Sufficient distance from the vehicles ahead may not be guaranteed in these cases.

Stationary objects and vehicles

The device can detect stationary vehicles from 2.5 to 37 mph (4 to 60 km/h). Pay the utmost attention at all times and be always ready to press the brakes if needed.

Objects and vehicles moving in opposite or crosswise direction

The device cannot detect the presence of objects or vehicles travelling in opposite or at right-angles and consequently will not be operated.



WARNING

130) Pay the utmost attention while driving at all times and be always ready to press the brakes if needed.

131) The system is an aid for the driver, who must always pay full attention while driving. The responsibility always rests with the driver, who must take into account the traffic conditions in order to drive in complete safety. The driver must always maintain a safe distance from the vehicle in front.

132) The device is not activated in presence of pedestrians, oncoming vehicles in the opposite direction of travel or moving in the crosswise direction and stationary

objects (e.g. a vehicle standing in a queue or a broken down vehicle).

133) The device cannot take account of road, traffic and weather conditions and conditions of poor visibility (e.g. fog).

134) The device does not always fully recognise complicated driving conditions which could cause incorrect or non-existing determination of the safe distance to be held.

135) The device cannot apply the maximum braking force: the car will not be stopped completely.

136) It is dangerous to leave the device on when it is not used. There is a risk of inadvertently activating it and losing control of the car due to unexpected excessive speed.

137) The device detects the direction of traffic automatically when the car passes from left-hand traffic to right-hand traffic. In this case, the overtaking assist function is only active when the reference vehicle is overtaken on the right. The additional acceleration is activated when the driver uses the right direction indicator. In this condition, the device no longer provides the overtaking assist function on the left-hand side until it determines that the car has returned to left-hand traffic conditions.

138) The maximum braking applied by the device is limited. The driver may apply the brakes in all cases if needed.

139) If the device predicts that the level of braking is not sufficient to maintain the set distance, the word "BRAKE!" or a dedicated message on the instrument panel display warns the driver that the vehicle ahead is too close. An acoustic warning is also



ABC

emitted. In this case, it is advisable to brake immediately as necessary to hold a safe distance from the vehicle ahead.

140) The driver is responsible for ensuring that there are no pedestrians, other vehicles or objectives along the direction of the vehicle. Failure to comply with these precautions may cause serious accidents and injuries.

141) The driver is fully responsible for holding a safe distance from the vehicle ahead respecting the highway code in force in the respective country.



IMPORTANT

40) The system may have limited operation or not work at all in weather conditions such as: heavy rain, hail, thick fog, heavy snow.

41) The section of the bumper area in front the sensor or the radar sensor itself must not be covered with stickers, auxiliary headlights or any other object.

42) Operation can be adversely affected by any structural change made to the vehicle, such as a modification to the front geometry, tyre change, or a heavier than standard load of the vehicle.

43) Incorrect repairs made on the front part of the car (e.g. bumper, chassis) may alter the position of the radar sensor, and adversely affect its operation. Go to an Alfa Romeo Dealership for any operation of this type.

44) Do not tamper with or carry out any intervention on the radar sensor or on the camera on the windscreen glass. In the

event of a sensor failure, contact an Alfa Romeo Dealership.

45) Do not wash with high-pressure jets in the bumper lower area: in particular do not operate on the system's electrical connector.

46) Be careful in the case of repairs and new paintings in the area around the sensor (panel covering the sensor on the left side of the bumper). In the event of a frontal collision the sensor may automatically deactivate and display a warning to indicate that the sensor needs to be repaired. Even without a malfunction warning, deactivate the system operation if you think that the position of the radar sensor has changed (e.g. due to low-speed frontal collision as during parking manoeuvres). In these cases, go to an Alfa Romeo Dealership to have the radar sensor realigned or replaced.

HAS (Highway Assist) SYSTEM

(where provided)

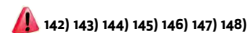

This is a driving assistance system which works only when driving on motorways, up to a top speed of 90 mph (145 km/h), when horizontal signs are detected.

The system uses information from the front camera and radar to help you keep the car in the middle of the lane and at a constant speed.

The HAS system combines Active Cruise Control (ACC) and lane centring logic to control the trajectory of the car holding it as close as possible in the middle of the lane and also managing speed.

Once the HAS is activated, a dedicated screen will appear on the display of the instrument panel (see the following pages).

OPERATION

The system works only if the driver keeps both hands on the steering wheel.

If your hands are removed from the steering wheel, the system alerts you of the need to put your hands back on the steering wheel (see following pages).

If the vehicle crosses the lane marking, the steering wheel will vibrate and a dedicated screen will appear on the instrument panel display.

WARNING The HAS can take a few seconds to activate once all conditions are met. During this time, a grey indication will appear on the instrument panel display and the system will be activated automatically as soon as all conditions are met, without any intervention by the driver.



177

07146V0990EM

The following conditions must be met before the HAS turns on:

- the HAS system must be switched on by pressing the button fig. 177 on the steering wheel;
- it is necessary to drive on the motorway;
- the Active Cruise Control device (ACC) must be on;
- the right and left lane marking lines must be visible and correctly detected by the front camera;
- the car must be driving at a speed from 0 to 90 mph (0 to 145 km/h);

- no camera, radar or Connect system anomaly must be present;
- the motorway lane width must be between 8.5 ft and 13.7 ft (2.6 metres and 4.2 metres);
- the direction indicators must not be activated;
- no anomaly related to the system must be present.

Other operating limits:

- if the speed of the ACC device can be set to a higher value (top speed 110 mph / 180 km/h), the HAS is only available as long as the vehicle speed is equal to or less than 90 mph (145 km/h);
- when the ACC device speed is reduced and the vehicle speed is less than 90 mph (145 km/h), the system will reactivate automatically;
- if the ACC speed is set 90 mph (145 km/h) and with the HAS active the vehicle speed exceeds 90 mph (145 km/h) due to a slope, the system will deactivate automatically.

ACTIVATION / DEACTIVATION

To activate the system, press the  button on the left side of the steering wheel fig. 177.

To deactivate the system press the button again.

Suspension conditions

Carry out one of the following

operations:

- start steering manually;
- press the brake pedal;
- disable the ACC device;
- activate the direction indicators;
- press the ACC device distance setting button for 2 seconds to activate the Cruise Control;
- put the shift lever in P (park), R (reverse) or N (neutral).

When the cause for suspension ends, to reactivate the HAS you need to reactivate the ACC device (for operation of the ACC device, see the "Active Cruise Control" chapter in this section).

Automatic deactivation

System operation is temporarily cancelled in the following cases:

- if there are too narrow bends;
- when hands are taken off from the steering wheel;
- if the left or right direction indicator is activated;
- if the driver intentionally changes lanes without switching on the direction indicator on the corresponding side;
- if the driver's seat belt is released;
- if the gear is moved from D (Drive);
- if the "Active braking" function is activated (see the description in the "FCW (Forward Collision Warning)



ABC

system" paragraph in the "Safety" section;

- if the car leaves the motorway;
- if lane marks are not detected by the camera;
- if there are system anomalies;
- if the ACC device is deactivated;
- if the vehicle speed exceeds the top speed limit of the system (top speed 90 mph / 145 km/h);
- if the lateral accelerations exceed the limits envisaged by the system.

WARNING When the HAS is paused, the symbol  on the display turns red and then grey.

WARNING Hands on the steering wheel are detected by a capacitive sensor installed in it.

When the automatic suspension conditions are over, the HAS will be available again without requiring any reactivation action by the driver.

INDICATIONS ON THE DISPLAY

With the "Driver Assistance" screen active, the following information is displayed in the central area of the display fig. 178 on the instrument panel:

- (1) symbol : this indicates that the system has been activated. The system status is indicated by the colour of the symbol.;

- (2) side marker lines: when the HAS system has been activated by the driver the display of the LKA (Lane Keeping Assist) system will be replaced by the HAS system lines. The side marker lines can be of different colours according to the status of the system;
- (3) secondary visual indication: this provides the driver with a constant indication of the status of the HAS system;
- (4) icon of the vehicle in front;
- (5) distance display from the vehicle in front.



178

9490225

The HAS system uses the sensors on the steering wheel rim to detect if the driver's hands are placed on the steering wheel.

If the driver's hands are not positioned on the steering wheel, a series of warnings will appear on the instrument panel display to alert the driver that he needs to reposition his hands on the

steering wheel. Acoustic signals will also be emitted.

After a certain time, the HAS system will be disabled and will provide an acoustic and visual warning, by displaying a dedicated message on the instrument panel display, if you do not put your hands back on the steering wheel.

When the system does not detect hands on the steering wheel, it will warn the driver by displaying a dedicated screen at the centre of the instrument panel.

SYSTEM STATUS

Active system

The active and correctly functioning system status is indicated by a dedicated screen in the "Driver Assistance" menu on the display of the instrument panel.

If you are in a different menu, a screen will appear on the instrument panel display, which will provide information on the system activation status fig. 179.



179

9490493

If you remove your hands from the steering wheel, the system will deactivate automatically but after a few seconds. The display will show a sequence of dedicated screens and beeps to warn you of the need to reposition your hands on the steering wheel (see below).

Active system (hands removed from the steering wheel for a short time)

As soon as you remove your from the steering wheel, this screen fig. 180 appears on the instrument panel display: in this case, the system remains active.



180

9490302

If you do not put your hands back on the steering wheel within a few seconds, this screen fig. 181 will appear on the instrument panel display.

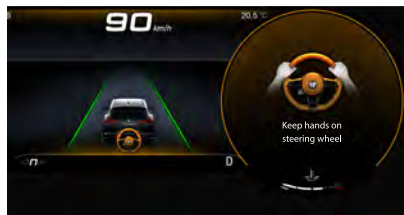

181

9490303

Active system (hands removed from the steering wheel for a long time)

If the driver has not yet returned his or her hands to the steering wheel, this screen fig. 182 will appear on the instrument panel display. A continuous acoustic warning will sound also in this case continued.



182

9490492

If you do not put your hands back on the steering wheel after a long period of time, a deactivation message fig. 183 will appear on the instrument panel display

together with another acoustic warning. The steering wheel control will then be deactivated.



183

9490491

If the HAS is deactivated because your hands are not on the steering wheel, the ACC (Active Cruise Control) will also be deactivated.

When the HAS is active, the LKA (Lane Keeping Assist) / LDW (Lane Departure Warning) systems (where applicable) will be temporarily paused. When the HAS is not active, the LKA (Lane Keeping Assist) / LDW (Lane Departure Warning) systems (where applicable), if activated previously, remain available. For more information on the LKA and LDW systems, see the following pages in this chapter.

SYSTEM AVAILABILITY

External factors and conditions may affect the proper operation of the HAS.

The main ones are listed below:



ABC

- ❑ narrow, winding and curvy streets;
- ❑ poor visibility (due to heavy rain, snow, fog, etc.);
- ❑ front lights of incoming cars or direct sunlight or shade;
- ❑ damage or obstructions caused by mud, ice, snow, etc.;
- ❑ bumper damaged or not aligned;
- ❑ interference with other equipment that causes electromagnetic waves;
- ❑ presence of roadworks/road construction sites;
- ❑ if the indications given by the navigation system (if any) of the Connect system are not yet ready and/or if the navigation system is recalculating the route.

SYSTEM LIMITED OPERATION

The HAS may have limited or reduced functionality when one of the following conditions occurs:

The main ones are listed below:

- ❑ lane marking lines are not clear or in conditions of poor visibility (e.g. in heavy rain, snow, fog, etc.);
- ❑ either the camera or radar are damaged, covered or obstructed (e.g. by mud, ice, snow, etc.);
- ❑ when driving in the hills or on roads with narrow turns;
- ❑ near motorway toll-gates;
- ❑ when the motorway entrance or exit does NOT have a lane width between 8,5 ft and 13,7 ft (2.6 metres and 4.2 metres);
- ❑ if the camera is exposed to dazzling light (e.g. reflection or direct sunlight);
- ❑ if the Navigation system information is not available and/or is being recalculated.



WARNING

142) Many unpredictable situations that can affect the performance of the HAS system may arise. The driver must be ready to react immediately and take control of the car in place of the HAS system.

143) If the car approaches a bend that is too narrow with respect to the current speed, the HAS system turns off. The driver must therefore be ready to immediately regain control of the car at any time. To avoid this situation it is important that the car speed set does not exceed the current road speed limit and that the driver keeps his or her hands on the steering wheel.

144) The HAS system uses a hands on steering wheel detection sensor: the driver must keep his hands on the steering wheel at all times. If the hands are removed from the steering wheel for a certain period of time, the system disengages and the ACC is paused.

145) When using the HAS system, hold the steering wheel and take into consideration the road conditions and the surrounding traffic. The driver must therefore be ready to immediately regain control of the car

at any time. Failure to observe these instructions can cause severe injuries with even lethal consequences.

146) The HAS system is an aid for the driver, who must always pay full attention while driving. The responsibility always rests with the driver, who must take into account the traffic conditions in order to drive in complete safety. The driver must always maintain a safe distance from the vehicle in front.

147) If the windscreen must be replaced due to scratches, chipping or breakage, contact exclusively an Alfa Romeo Dealership. Do not replace the windscreen on your own, risk of malfunction! It is advisable to replace the windscreen if it is damaged in the area of the camera.

148) Do not place any objects on the steering wheel (e.g. steering wheel covers of any type or material) which could interfere with the capacitive hand detection sensor on the steering wheel.

TJA (Traffic Jam Assist) SYSTEM

(where provided)

 149) 150) 151) 152) 153) 154) 155) 148)

It is a driving assistance system that can be activated on all road types.

The system uses information from the front camera and radar to help you keep the car in the middle of the lane at a constant speed.

If the event that the lane marking line is missing or not correctly recognised, the TJA system may also use information from adjacent and preceding vehicles. This condition may occur in congested traffic, when the car in front and/or objects around the car obstruct the lane markings. In this case, the system can use the queues of cars in the traffic to define the driving trajectory. Alternatively, at speeds below 18 mph (20 km/h), the system can use the "lock-on" strategy, which allows it to automatically following the car in front.

The HAS combines Active Cruise Control (ACC) functions and lane centring logic to control the trajectory of the car holding it as close as possible in the middle of the lane and also managing speed.

WARNING Do not use the TJA system while driving in urban traffic.

OPERATION

The system only works if the driver keeps his or her hands on the steering wheel.

If the system detects that hands have been removed from the steering wheel, it will alert you of the need to put your hands back on the steering wheel (see following pages).

WARNING If the vehicle is about to cross the lane marking, the steering wheel will vibrate and a dedicated screen will appear on the instrument panel display.

WARNING The TJA can take a few seconds to activate once all conditions are met. During this time, a grey indication will appear on the instrument panel display and the system will be activated automatically as soon as all conditions are met, without any intervention by the driver.



184

07146V0990EM

The following conditions must be met before the TJA turns on:

- the TJA must be switched on by pressing the button fig. 184 on the steering wheel;
- the Active Cruise Control device (ACC) must be on;
- the car must be driving at a speed from 0 to 40 mph (0 to 60 km/h);
- no camera, radar or Connect system anomaly must be present;
- the road lane width must be between 8.5 ft and 13.7 ft (2.6 metres and 4.2 metres);
- the direction indicators must not be activated;
- no anomaly related to the system must be present;
- if the set speed is above 40 mph (60 km/h), the TJA system will not operate after the vehicle has exceeded 40 mph (60 km/h);
- if the speed of the Active Cruise Control (ACC) device can be set to a higher value (top speed 180 km/h), the TJA is only available as long as the vehicle speed is lower than or equal to 40 mph (60 km/h);

ACTIVATION / DEACTIVATION

To activate the system, press the  button on the left side of the steering wheel.



ABC

To deactivate the system press the button again.

Suspension conditions

Perform one of the following operations:

- press the brake pedal;
- open the driver's door;
- disable the ACC device;
- if the vehicle speed exceeds the top speed limit (top speed 40 mph / 60 km/h);
- release the driver's seat belt;
- put the shift lever in P (park), R (reverse) or N (neutral);
- if the FCW (Forward Collision Warning) system or "Active braking" intervenes.

Automatic deactivation

System operation is temporarily paused in the following cases:

- if there are very tight bends;
- if the lines are not detected correctly;
- one of the two lines is broken or ruined;
- the sun is low and is dazzling the camera on the windscreen;
- if the left or right direction indicator is activated;
- if the driver intentionally changes lanes without switching on the direction indicator on the corresponding side;
- if manual steering starts;
- if you take your hands off the steering wheel;

- when there is no surrounding traffic and there are no horizontal markings or they cannot be detected;
- if there are system anomalies;
- if the car speed exceeds the maximum limit;
- if lateral acceleration is high.

WARNING When the TJA is paused, the  symbol on the display turns red and then grey.

WARNING Hands on the steering wheel are detected by a capacitive sensor installed in it.

When the automatic suspension conditions are over, the TJA will be available again without requiring any reactivation action by the driver.

INDICATIONS ON THE DISPLAY

With the "Driver Assistance" screen active, the following information is displayed in the central area of the display fig. 185 on the instrument panel:

- (1) symbol : this indicates that the system has been activated. The system status is indicated by the colour of the symbol;
- (2) side marker lines: when the TJA system has been activated by the driver the display of the LKA (Lane Keeping Assist) system will be replaced by the TJA system lines. The side marker lines

can be of different colours according to the status of the system;

- (3) secondary visual indication: this provides the driver with a constant indication of the status of the HAS system;
- (4) icon of the vehicle in front;
- (5) distance display from the vehicle in front.

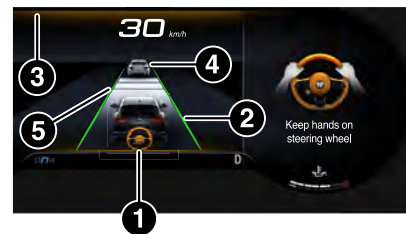

185

9490525

The TJA system uses the sensors on the steering wheel rim to detect if the driver's hands are placed on the steering wheel.

If the driver's hands are not positioned on the steering wheel, a series of warnings will appear on the instrument panel display to alert the driver that he needs to reposition his hands on the steering wheel. Acoustic signals will also be emitted.

After a certain time, the TJA system will be disabled and will provide an acoustic and visual warning, by displaying a

dedicated message on the instrument panel display, if you do not put your hands back on the steering wheel.

When the system does not detect hands on the steering wheel, it will warn the driver by displaying a dedicated screen at the centre of the instrument panel.

SYSTEM STATUS

Active system

The active and correctly operating system status is indicated by the following screen on the instrument panel display fig. 186 in the "Driver Assistance" menu.



186

9490526

When the hands are removed from the steering wheel, the system does not deactivate automatically, but after a few seconds: some dedicated screens appear on the instrument panel display in sequence, to warn the driver to return his or her hands to the steering wheel (see the description below).

Active system (hands removed from the steering wheel for a short time)

As soon as you remove your from the steering wheel, this screen fig. 187 appears on the instrument panel display: in this case, the system remains active.



187

9490527

If you do not put your hands back on the steering wheel within a few seconds, this screen fig. 188 will appear on the instrument panel display.



188

9490528

Active system (hands removed from the steering wheel for a long time)

If the driver has not yet returned his or her hands to the steering wheel, this screen fig. 189 will appear on the instrument panel display. A continuous acoustic warning will sound also in this case continued.



189

9490529

If you do not put your hands back on the steering wheel after an extended period of time, a deactivation message fig. 190 will appear on the instrument panel display together with another acoustic warning.



ABC



190

9490530

If the TJA system was deactivated because your hands were not on the steering wheel, the Active Cruise Control (ACC) will also be deactivated and must be reactivated.

When the TJA is active, the LKA (Lane Keeping Assist) / LDW (Lane Departure Warning) systems (where applicable) will be temporarily paused. When the TJA is not active, the LKA (Lane Keeping Assist) / LDW (Lane Departure Warning) systems (where applicable), if activated previously, remain available. For more information on the LKA and LDW systems, see the following pages in this chapter.

SYSTEM AVAILABILITY

External factors and conditions may affect the proper operation of TJA.

The main ones are listed below:

- ❑ narrow, winding and curvy streets;

- ❑ poor visibility (due to heavy rain, snow, fog, etc.);
- ❑ front lights of incoming cars or direct sunlight or shade;
- ❑ damage or obstructions caused by mud, ice, snow, etc.;
- ❑ bumper damaged or not aligned;
- ❑ interference with other equipment that causes electromagnetic waves;
- ❑ presence of roadworks/road construction sites;
- ❑ if the indications given by the navigation system (if any) of the Connect system are not yet ready and/or if the navigation system is recalculating the route.

SYSTEM LIMITED OPERATION

The TJA may have limited or reduced functionality when one of the following conditions occurs:

The main ones are listed below:

- ❑ lane marking lines are not clear or in conditions of poor visibility (e.g. in heavy rain, snow, fog, etc.);
- ❑ either the camera or radar are damaged, covered or obstructed (e.g. by mud, ice, snow, etc.);
- ❑ when driving in the hills or on roads with narrow turns;
- ❑ near motorway toll-gates;
- ❑ if the camera is exposed to dazzling light (e.g. reflection or direct sunlight).



WARNING

149) Many unpredictable situations can arise, affecting the performance of the TJA system. The driver must be ready to react immediately and take control of the car in place of the TJA system.

150) If the car approaches a bend that is too tight with respect to the current speed, the TJA system turns off. The driver must therefore be ready to immediately regain control of the car at any time. To avoid this situation it is important that the car speed set does not exceed the current road speed limit.

151) The TJA system uses a hands on steering wheel detection sensor: the driver must keep his hands on the steering wheel at all times. If the hands are removed from the steering wheel for a certain period of time, the system disengages and the ACC turns off.

152) When using the TJA system, hold the steering wheel and consider the road conditions and surrounding traffic. The driver must therefore be ready to immediately regain control of the car at any time. Failure to observe these instructions can cause severe injuries with even lethal consequences.

153) The TJA system is an aid for the driver, who must always pay full attention while driving. The responsibility always rests with the driver, who must take into account the traffic conditions in order to drive in complete safety. The driver must always maintain a safe distance from the vehicle in front.

154) If the windscreen must be replaced due to scratches, chipping or breakage, contact exclusively an Alfa Romeo Dealership. Do not replace the windscreen on your own, risk of malfunction! It is advisable to replace the windscreen if it is damaged in the area of the camera.

155) Driving the car on urban routes could significantly change the sensitivity of the system, due to the limited and/or lack of vertical and horizontal signage and variable traffic conditions. Therefore, it is recommended not to use the TJA system when driving in city streets.

156) Do not place any objects on the steering wheel (e.g. steering wheel covers of any type or material) which could interfere with the capacitive hand detection sensor on the steering wheel.

TSR (Traffic Sign Recognition) SYSTEM

(where provided)

 157) 158) 159)

 47) 48) 49) 50) 51)

The system automatically detects the recognizable road signs through a camera located in the central area of the windscreen:

- speed limits;
- no overtaking;
- signs indicating the end of the prohibitions indicated above.

If the camera does not detect valid speed limits, the Connect system navigation (where provided) may suggest unregulated speed limits.

The system always checks the traffic signs indicating the current speed limit and possible no overtaking signs. The system is able to recognise and show on the instrument panel display, up to two different road signs.

Depending on the unit of measurement ("km" or "mph") set through the "Unit of measurement" menu on the Connect system, the TSR system will automatically show on the instrument panel display the indication of the road sign in the unit of measurement set.

TSR SYSTEM USE

System activation / deactivation

The system can be activated/deactivated using the "Driver Assistance" menu and then selecting "Comfort" on the Connect system.

The system activation is signalled by the road signs shown on the instrument panel display.

NOTE The TSR system will always be active every time the engine is started.

WARNING Selecting "Blinking" it is possible to activate a warning when the effective car speed exceeds that indicated by the TSR system and displayed on the instrument panel. In

this case, the speed road sign on the instrument panel display will blink until the effective speed drops below the displayed limit. Selecting "Offset", it is possible to set the threshold at which "Blinking" is activated, up to a maximum of 6 mph (10 km/h) above the limit detected by the system.

Indications on the display

The system status can always be viewed in the central area the instrument panel display fig. 191.

The display will show the following information:

- the new speed limit recognised by the system (1) is always visible and indicated by means of a predetermined colour. The previously displayed sign is no longer valid after a certain distance has been travelled if the system does not detect other road signs and the limit given by the navigation system maps (where provided) is indicated on the display;
- no overtaking road sign (2)

NOTE The road sign indicating the end of the speed limit or "road sign not detected" may appear in zone (1) fig. 191 .



ABC

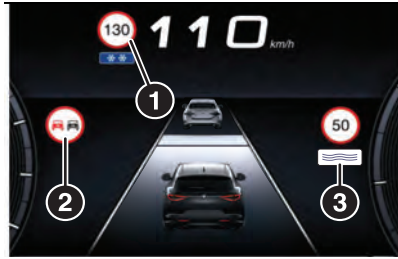

191

9490185

The TSR system cannot provide an applicable speed limit in the following cases:

- ❑ if an end-of-limit sign is recognised and if the navigation system (where provided) is unable to provide a valid limit on that stretch of road. The symbol appears on the display (1)
- ❑ in case of system fault or unavailability, the symbol appears on shown on the display (2)

NOTE In some cases, the system may show this symbol (2) when recalculating the route by the navigation system (where provided).

Additional traffic signal

The system can identify an additional road sign (3) fig. 191, e.g. a lower speed limit in case of fog. This will only be shown in the dedicated area of the instrument panel display when the following conditions occur:

- ❑ the additional fog sign will appear if the front or rear fog lights are on;
- ❑ the additional snow signal will appear if the outside temperature is equal to or lower than 37.4°F (3°C) and the windscreen wipers are working;
- ❑ the additional rain signal will appear if the windscreen wipers are working;

The no overtaking road sign (2) fig. 191 may also be shown on the display.

In addition to the dedicated area on the instrument cluster display, the various traffic signs detected by the system can be seen in the "Driver Assistance" area on the Connect system display.

If a trailer and its light connector are connected to the car, the instrument panel display will show the additional trailer connected sign.



WARNING

157) The system only detects preset traffic signs if the minimum visibility conditions and distance from the sign are met.

158) The system is an aid for driving and does not relieve the driver of responsibility for driving the car. Always respect the highway code of the country you are driving in.

159) When the system is active, the driver is responsible for controlling the car and

monitoring the system, and must be ready to intervene as appropriate if necessary.



IMPORTANT

47) Functionality may be limited or the system may not work if the sensor is obstructed.

48) The system may have limited operation or not work at all in weather conditions, such as heavy rain, hail, thick fog and low temperatures. Strong light contrasts can influence the recognition capability of the sensor.

49) The area surrounding the sensor must not be covered with stickers or any other object.

50) Do not tamper or perform any operations in the area of the windscreen glass directly surrounding the sensor.

51) Clean the windscreen glass from foreign matters such as bird droppings, insects, snow or ice. Use specific detergents and clean cloths to avoid scratching the windscreen.

ISC (Intelligent Speed Control) SYSTEM

(where provided)

The ISC system, where provided, is combined with the ACC (Active Cruise Control) system and TSR (Traffic Sign Recognition) system and suggests an automatic speed adjustment to the driver based on the speed limit for the road being travelled.

You can decide whether to accept or reject the proposal to adjust the speed set by the ACC to match the one suggested by the speed limit symbol by using the RES/SET lever located on the steering wheel fig. 192. A corresponding icon will be shown on the instrument panel display (see description in respective paragraph).

If the speed limit determined by reading the road signs or by traffic conditions is exceeded, the speed limit will flash on the instrument panel.



192

07146V0022EM

ACTIVATION / DEACTIVATION

Activation

The system can be activated/deactivated using the "Driver Assistance" menu and then selecting "Comfort" on the Connect system.

Engine stopping is signalled by the (1) fig. 193 symbol lighting up on the instrument panel display.

Deactivation

The system is deactivated under the following conditions:

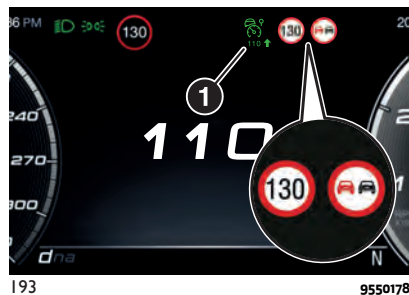

- when the Traffic Sign Recognition system is deactivated;
- when the Active Cruise Control device is deactivated.



WARNING Selecting "Speed Offset" it is possible to set the speed increment to which the ISC system will adjust, up to a maximum of 6 mph (10 km/h) above the speed limit sign detected by the system, or the speed decrement to which the ISC

system will adjust, down to a minimum of 6 mph (10 km/h) below the speed limit sign detected by the system. In these cases, the road sign information shown on the instrument panel display will remain that detected by the TSR system.

INDICATIONS ON THE DISPLAY

The system status is always shown by a dedicated white or green icon  /  /  on the instrument panel display (similar to that for the Active Cruise Control device), to the left of the road sign indications provided by the TSR system.

ACCEPTANCE / REJECTION OF THE SUGGESTED SPEED

The system can be activated if the driver has previously activated:

- the Active Cruise Control device;
- the Traffic Sign Recognition system.

When these systems are active, the instrument panel display can show an icon that indicates the suggested speed (provided by the TSR system) (1) fig. 194 or (2) fig. 195, which the driver can decide to accept or reject using the RES/SET lever on the steering wheel.

To accept the proposed speed and consequently adjust the speed set by the Active Cruise Control, move the RES/SET lever in the direction of the



ABC

green arrow displayed next to the ISC system icon.

Otherwise (moving the RES/SET lever in the opposite direction to that of the arrow on the display) the driver rejects the proposed speed, and the Active Cruise Control will continue to regulate to the previously set speed.

If the driver accepts the value suggested by the ISC or if the speed set using the Active Cruise Control device is the same as the that detected by the Traffic Sign Recognition system, the speed limit sign on the instrument panel display will be highlighted with a green circle (1) fig. 196.

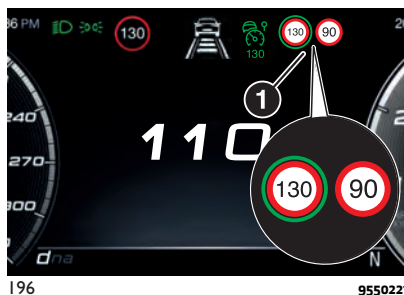
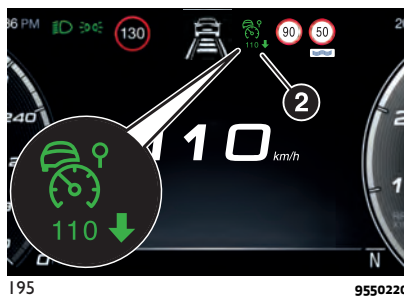
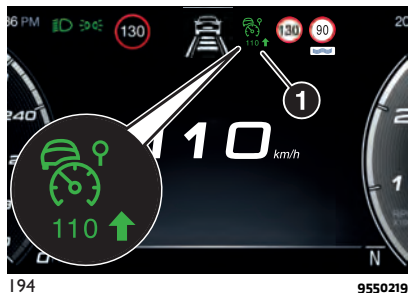

PARK SENSORS SYSTEM

(where provided)

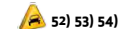

The parking sensors, located in the front bumper (only 8-sensor version) (fig. 197) and rear bumper (4 or 8-sensor versions) (fig. 198), detect the presence of any obstacles and warn the driver through an acoustic warning and, where provided, visual indications on the instrument panel display.



197

9490112

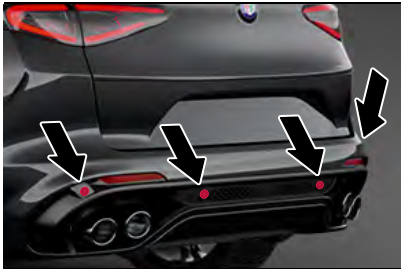

198

9490111

Turning the front and rear sensors on/off (where provided)

The system can be turned off using the "Driver Assistance" menu and then select "Comfort" on the Connect system.

When the ignition device is set to ON the Park Sensors system keeps the last state when the engine was stopped (activated or deactivated) in its memory. If the button fig. 199 is pressed with a system failure, the LED flashes for about 5 seconds, then it stays on constantly.



199

9490198

System activation / deactivation

For 4-sensor versions: the system, when engaged, is automatically activated by engaging the reverse gear, while it is deactivated by engaging another gear.

For 8-sensor versions: when the reverse gear is engaged and the system is on, the front and rear sensors are activated.

If a different gear is engaged, the rear sensors are deactivated, while the front sensors remain active until 9.3 mph (15 km/h) are exceeded.

WARNING In particular operating conditions the system could start detecting the obstacle only after the car has moved slightly (a few centimetres).

Acoustic warning

When reverse gear is engaged and an obstacle is encountered at the rear (for versions with 4 or 8 sensors) or at the front (only for versions with 8 sensors), an acoustic signal with variable frequency is activated that:

- increases as the distance between the car and the obstacle decreases;
- becomes continuous when the distance between the car and the obstacle is less than 12 in (30 cm) and stops if the distance increases;
- is constant if the distance between the car and the obstacle is unchanged.

For 4-sensor versions: If several obstacles are detected by the sensors,

only the nearest one is considered. The acoustic signal is not activated if the lever is positioned in position P (Park) or N (Neutral).

For 8-sensor versions: if the sensors detect several front and rear obstacles, the acoustic signal concerning the closest obstacle is emitted, or an intermittent signal if the obstacles are at the same distance.

When the system emits an acoustic signal, the volume of the Connect system, if activated, is automatically lowered.

Warning on display

The Park Sensors system signals are shown along with an acoustic indication only if the function was enabled on the Connect system. To access the function, on the main menu select the following items in sequence: "Settings", "Driver Assistance", "Parking sensors", "Mode" and "Sound and Display".

The system indicates the presence of an obstacle by displaying a single arc in one of the possible areas, in accordance with the distance of the object and the position in relation to the car.

If the obstacle is detected in the front or rear central area (excluding 4-sensor versions), a single arc will be displayed as the obstacle approaches, first constant, then flashing, in addition to an acoustic signal.



ABC

If the obstacle is detected in the front area (excluding 4-sensor version) or in the rear left and/or right area, a single flashing arc will be shown in the corresponding area on the display and the system will emit an acoustic signal, either at frequent intervals or constantly. If several obstacles are detected simultaneously in the front area (excluding 4-sensor version) and rear area, the display will show all of them, regardless of the area in which they were detected.

In general, the car is closer to the obstacle when a single or several flashing arcs are shown on the display and the acoustic warning becomes continuous. The colour on the display depends on the distance from and position of the obstacle.

It is possible to exit from the display screen by pressing the Rotary Pad. In any case: the audible signal will remain active.

Fault indication

Parking sensor faults, if any, will be indicated by a message on the display on the instrument panel (see description in the "Warning lights and messages" chapter, "Knowing the instrument panel" section).

Messages on the display

In case of system failure, a dedicated message appears on the instrument panel for about 5 seconds.

□ *Cleaning the front or rear sensors:* if the display shows messages requiring the front or rear sensor cleaning, make sure that the outer surface and the underside of the bumper is free of dirt (e.g. snow, mud, ice, etc.). After performing this check, place the ignition device in STOP position, then turn it to the ON position and check whether the messages are no longer displayed. If messages are still displayed, contact an Alfa Romeo Dealership.

□ *Sound system unavailable:* if the display shows the message that the audio system is not available, it means that the acoustic warning will be emitted by the instrument panel.

Operation with trailer

The operation of the rear sensors is automatically deactivated when the trailer is plugged to the tow hook socket of the car, while the front sensors (only for 8-sensor versions) stay active and can provide acoustic and visual warnings. The rear sensors are automatically reactivated when the trailer's cable plug is removed.

When parking, take the utmost care over obstacles that may be above or under the sensor. Objects close to the car are not

detected under certain circumstances and could therefore cause damage to the car or be damaged.

General warnings

Some conditions may influence the performance of the parking system:

□ reduced sensor sensitivity and a reduction in the parking assistance system performance could be due to the presence of: ice, snow, mud, thick paint, on the surface of the sensor;

□ the sensor may detect a non-existent obstacle ("echo interference") due to mechanical interference, for example when washing the car, in rain (strong wind), hail;

□ the signals sent by the sensor can also be altered by the presence of ultrasonic systems (e.g. pneumatic brake systems of trucks or pneumatic drills) near the car;

□ parking assistance system performance can also be influenced by the position of the sensors, for example due to a change in the ride setting (caused by wear to the shock absorbers, suspension), or by changing tyres, overloading the car or carrying out specific tuning operations that require the car to be lowered;

□ the presence of a tow hook without trailer, which may interfere with the correct operation of the parking sensors. Before using the Park Sensors system,

it is recommended to remove or close the tow hook ball assembly when the car is not used for towing. Failure to comply with this prescription may cause personal injuries or damage to cars or obstacles since, when the continuous acoustic warning is emitted, the tow hook ball is already in a position that is much closer to the obstacle than the rear bumper. If you wish to leave the tow hook fitted without towing a trailer, it is advisable to contact an Alfa Romeo Dealership for the Park Sensors system update operations because the tow hook could be detected as an obstacle by the central sensors;

the presence of adhesives on the sensors. Therefore, take care not to place stickers on the sensors.



WARNING

160) *Parking and other potentially dangerous manoeuvres are, however, always the driver's responsibility. When performing these operations, always make sure that there are no other people (especially children) or animals on the route you want to take. The parking sensors are an aid for the driver, but the driver must never allow their attention to lapse during potentially dangerous manoeuvres, even those executed at low speeds.*



IMPORTANT

52) *For correct operation of the system, sensors must always be clean from mud, dirt, snow or ice. Be careful not to scratch or damage the sensors while cleaning them. Avoid using dry, rough or hard cloths. The sensors must be washed using clean water, with the addition of vehicle shampoo if necessary. When using special washing equipment such as high pressure jets or steam cleaning, clean the sensors very quickly keeping the jet more than 10 cm away.*

53) *Have interventions on the bumper in the area of the sensors carried out only by an Alfa Romeo Dealership. Interventions on the bumper that are not carried out properly may compromise the operation of the parking sensors.*

54) *Only have the bumper repainted or any retouches to the paintwork in the area of the sensors carried out by an Alfa Romeo Dealership. Incorrect paint application could affect the operation of the parking sensors.*

LANE DEPARTURE WARNING (LDW) SYSTEM

(where provided)

DESCRIPTION

 **55) 56) 57) 58)**

The Lane Departure Warning system makes use of a camera located on the windscreen to detect the lane limits, calculate the position of the vehicle within such limits and possibly indicate departure to the driver.

When one or both lane limits are detected and the vehicle passes over one without the driver's say-so (direction indicator not turned on), the system will emit an acoustic signal.

If the vehicle continues to go beyond the line of the lane without any intervention from the driver, the surpassed line will light up on the instrument panel display (left or right) to urge the driver to bring the vehicle back into the limits of the lane.

SYSTEM ON/OFF

The system can be turned on/off by pressing the fig. 200 button or using the "Driver Assistance" menu and then selecting "Safety" on the Connect system.

Each time the engine is started the system maintains the operating mode



ABC

that was selected when it was previously switched off.



200

0722650001EM

Activation conditions

Once switched on, the system becomes active only if the following conditions are met:

- the car speed is equal to or higher than 40 mph (60 km/h) (the system is deactivated at speeds higher than 110 mph/180 km/h);
- the lane limit lines are visible at least on one side;
- there are suitable visibility conditions;
- the road is straight or with wide radius bends;
- a safe distance is kept from the vehicle in front;
- the direction indicator (for leaving the lane) is not active.

SYMBOLS AND MESSAGES ON THE DISPLAY

The Lane Departure Warning system also advises the driver when the car changes lane by showing symbols and messages on the instrument panel display.

The message on the instrument panel display remains active only until the main reconfigurable area of the display is activated (see the description in the "Display" chapter in the "Knowing the instrument panel" section) pressing "MENU VIEW" button located on the right steering wheel stalk.

Activating the main reconfigurable area the messages related to the Lane Departure Warning system will be shown in this area.

When the system is active and the lane limits have not been detected, the display shows the following page, fig. 201.



201

9490500

Exiting a lane with detection of a single limit

When the system is active and only, for example, the left lane limit has been detected, the detected lane lights up in white on the instrument panel display, fig. 202. The system is ready to provide visual warnings on the display in the event of exiting the lane unintentionally (direction indicator not activated) to the left.



202

9490497

When the system detects that the car has approached the lane line and is about to overtake it, the left line on the instrument panel display lights up yellow, fig. 203.



203

9490496

The system operates in the same way, but mirrored, in the event of exiting the right lane when only the right lane limit has been detected.

Exiting a lane with detection of both limits

When the system is active, the lane lines on the display become white to indicate the successful detection of the limits.

The system is ready to provide indications in case of accident lane departure (direction indicator not activated).

In accordance with the different conditions detected, the system can attract the attention of the driver by altering the lines that identify the lanes on the instrument panel display. In particular, the system can alter their colour (from white to yellow and vice versa).

The crossing of a marker line is indicated on the instrument panel by a flashing red line and acoustic warning emitted from the speakers on the side of the lane limit being crossed (e.g. if the vehicle is crossing the left line of the lane, the acoustic warning will come from the speakers on the left).

Changing the system sensitivity

The system sensitivity intervention can be adjusted using the "Driver Assistance" menu and then selecting "Comfort" on the Connect system.

The possible options are "High" or "Low".

System limited operation warning



If the dedicated message is shown on the instrument panel display, a condition limiting the system operation may have occurred. The possible reasons of this limitation are something blocking the camera view or a fault.

If an obstruction is signalled, clean the area of the windscreen by the interior rear-view mirror.

Although the car can still be driven in normal conditions, the system may be not completely available.

When the conditions limiting the system functions end, this will go back to normal and complete operation. Should the

fault persist, contact an Alfa Romeo Dealership.

System Fault Message

If the system switches off and the system  appears on the instrument panel display, it means that there is a failure on the system.

In this case, it is still possible to drive the vehicle, but you are advised to contact an Alfa Romeo Dealership as soon as possible.



IMPORTANT

55) *Projecting loads on the roof of the car may interfere with the correct operation of the camera. Before starting make sure the load is correctly positioned, in order not to cover the camera operating range.*

56) *If the windscreen must be replaced due to scratches, chipping or breakage, contact exclusively an Alfa Romeo Dealership. Do not replace the windscreen on your own, risk of malfunction! It is advisable to replace the windscreen if it is damaged in the area of the camera.*

57) *Do not tamper with nor operate on the camera. Do not close the openings in the aesthetic cover located under the interior rear-view mirror. In the event of a failure of the camera, contact an Alfa Romeo Dealership.*

58) *Do not cover the operating range of the camera with stickers or other objects. Also pay attention to other objects on the bonnet*



ABC

(e.g. a layer of snow) and make sure they do not interfere with the camera.

59) The camera may have limited or absent operation due to weather conditions such as: heavy rain, hail, thick fog, heavy snow, formation of ice layers on the windscreen glass.

60) Camera operation may also be compromised by the presence of dust, condensation, dirt or ice on the windscreen glass, by traffic conditions (e.g. cars that are driving not aligned with yours, car driving in a transverse or opposite way on the same lane, bend with a small radius of curvature), by road surface conditions and by driving conditions (e.g. off-road driving). Make sure the windscreen is always clean. Use specific detergents and clean cloths to avoid scratching the windscreen. The camera operation may also be limited or absent in some driving, traffic and road surface conditions.

LANE KEEPING ASSIST (LKA) SYSTEM

(where provided)

DESCRIPTION

 55) 56) 57) 58)

The Lane Keeping Assist system makes use of a camera located on the windscreen to detect the lane limits and calculate the position of the car within such limits, in order to make sure that it remains inside the lane.

When one or both lane limits are detected and the vehicle approaches one of them without the driver signalling the intention to do so (direction indicator not on), the system will apply a torque to the steering wheel to keep the vehicle in the lane and will generate a visual signal (the left or right lane will turn yellow). According to the type of signal set, it can also emit an acoustic signal and/or apply a vibration to the steering wheel.

If the vehicle continues to pass the lane without any intervention by the driver, the surpassed line will light up on the instrument panel display (the left or right lane will turn yellow) to urge the driver to return the vehicle into the limits of the lane.

SYSTEM ON/OFF

The system can be turned on/off by pressing the fig. 204 button or using the "Driver Assistance" menu and then selecting "Safety" on the Connect system.

Each time the engine is started the system maintains the operating mode that was selected when it was previously switched off.

The system is automatically switched off when a trailer is coupled.



204

0722650001EM

Activation conditions

Once switched on, the system becomes active only if the following conditions are met:

- the car speed is equal to or higher than 40 mph (60 km/h) (the system is deactivated at speeds higher than 110 mph/180 km/h);
- the lane limit lines are visible at least on one side;

- there are suitable visibility conditions;
- the road is straight or with wide radius bends;
- a safe distance is kept from the vehicle in front;
- the direction indicator (for leaving the lane) is not active.

SYMBOLS AND MESSAGES ON THE DISPLAY

The Lane Keeping Assist system also advises the driver when the car changes lane by showing symbols and messages on the instrument panel display.

Lane Keeping Assist information can be displayed in the right-hand dial, fig. 205, or in the central area (“Driver Assistance”) of the display, fig. 206.

NOTE The information is only displayed in the right-hand dial if the “Driver Assistance” screen is not selected.

The different colours of the icons shown on the display show the status of the system (for more information, see the description under “Lane keeping assist symbols” in the “Warning lights and messages” chapter in the “Knowing the instrument panel” section).



205

9550224

When the system is active and the lane limits have not been detected, the display shows the following page, fig. 206.



206

9490500

Exiting a lane with detection of a single limit

When the system is active and only, for example, the right lane limit has been detected, the detected lane lights up in white on the display; the system is ready to provide visual warnings on the display in the event of unintentional

exiting of the lane (direction indicator not activated) to the left.

When the system detects that the car has approached the lane line and is about to pass it, the right line on the display lights up in yellow, fig. 207.



207

9490495

If the system intervention lasts longer than 10 seconds, an additional acoustic and visual warning will be provided by displaying a dedicated message on the instrument panel display to prompt the driver to regain control of the vehicle.

If Lane Keeping Assist intervenes several times in a relatively short time without the driver acting on the steering wheel, increasingly longer warning tones will be emitted to draw the driver's attention.

The system operates in the same way, but mirrored, in the event of exiting the left lane when only the left lane limit has been detected.



ABC

Exiting a lane with detection of both limits

When the system is active, the lane lines on the display become white to indicate the successful detection of the limits fig. 208.

The system is ready to provide indications in case it is accidentally abandoned (direction indicator not engaged).



208

9490497

In accordance with the different conditions detected, the system can attract the attention of the driver by altering the lines that identify the lanes on the instrument panel display. In particular, the system can alter their colour (from white to yellow and vice versa).

The passing of the line is indicated also by means of an acoustic warning, is emitted from the loudspeakers on the side of the lane limit being crossed (e.g. if the vehicle is crossing the left line of the

lane, the acoustic warning will come from the loudspeakers on the left).

If the system intervention lasts longer than 10 seconds, an additional acoustic and visual warning will be provided by displaying a dedicated message on the instrument panel display to prompt the driver to regain control of the vehicle.

If Lane Keeping Assist intervenes several times in a relatively short time without the driver acting on the steering wheel, increasingly longer warning tones will be emitted to draw the driver's attention.

Hands presence on the steering wheel detection

The system is able to detect the presence of the driver's hands on the steering wheel:

- if you do not put your hands on the steering wheel and the system intervenes during a loss of control in a lateral direction, the instrument panel display will show dedicated screens and beeps of progressive duration will be emitted to prompt you to put your hands back on the steering wheel;
- if you continues not to put your hands to the steering wheel after the system intervenes, the read steering wheel and a dedicated message will appear on the instrument panel display.

In these two cases, the driver's hands must be put back on the steering wheel.

Changing the system sensitivity

The system intervention sensitivity can be adjusted using the "Driver Assistance" menu on the Connect system. The possible options are "High" or "Low".

Change of indications provided by the system

The indications provided by the Lane Keeping Assist system may be modified using the Connect system.

Proceed as follows:

- use the "Driver Assistance" menu;
- select "Settings" and then select "Warning type" or "Mode" and select one of the required settings.

System limited operation warning



If the dedicated message is shown on the instrument panel display, a condition limiting the system operation may have occurred. The possible reasons of this limitation are something blocking the camera view or a fault.

If an obstruction is signalled, clean the area of the windscreen by the interior rear-view mirror.

Although the car can still be driven in normal conditions, the system may be not completely available.

When the conditions limiting the system functions end, this will go back to normal and complete operation. Should the

fault persist, contact an Alfa Romeo Dealership.

System Fault Message

If the system switches off and the system  appears on the instrument panel display, it means that there is a failure on the system.

In this case, it is still possible to drive the vehicle, but you are advised to contact an Alfa Romeo Dealership as soon as possible.



IMPORTANT

61) Projecting loads on the roof of the car may interfere with the correct operation of the camera. Before starting make sure the load is correctly positioned, in order not to cover the camera operating range.

62) If the windscreen must be replaced due to scratches, chipping or breakage, contact exclusively an Alfa Romeo Dealership. Do not replace the windscreen on your own, risk of malfunction! It is advisable to replace the windscreen if it is damaged in the area of the camera.

63) Do not tamper with nor operate on the camera. Do not close the openings in the aesthetic cover located under the interior rear-view mirror. In the event of a failure of the camera, contact an Alfa Romeo Dealership.

64) Do not cover the operating range of the camera with stickers or other objects. Also pay attention to other objects on the bonnet

(e.g. a layer of snow) and make sure they do not interfere with the camera.

65) The camera may have limited or absent operation due to weather conditions such as: heavy rain, hail, thick fog, heavy snow, formation of ice layers on the windscreen glass.

66) Camera operation may also be compromised by the presence of dust, condensation, dirt or ice on the windscreen glass, by traffic conditions (e.g. cars that are driving not aligned with yours, car driving in a transverse or opposite way on the same lane, bend with a small radius of curvature), by road surface conditions and by driving conditions (e.g. off-road driving). Make sure the windscreen is always clean. Use specific detergents and clean cloths to avoid scratching the windscreen. The camera operation may also be limited or absent in some driving, traffic and road surface conditions.

REAR BACK-UP CAMERA / DYNAMIC GRIDLINES

DESCRIPTION

The Rear Back-up Camera is located on the tailgate, near the opening button, fig. 209.

 161)

 67)



209

07186V0001EM

Camera activation/deactivation

The function can be activated/deactivated using the "Driver Assistance" menu and then selecting "Comfort" on the Connect system.

Activating the device

After activating the camera, it will be possible to select one of the following options:

- "Activate"
- "Cam Delay"



ABC

□ "Camera Guidelines"

Select "Activate" to activate the camera view on the Connect system display.

Whenever reverse gear is engaged, the Connect system display, fig. 210, will show the area around the car, as seen by the Rear View Camera.



210

07186V0060EM

SYMBOLS AND MESSAGES ON THE DISPLAY

Activating the "Camera Guidelines" shows the guidelines on the display. If activated, the grid is positioned on the image to highlight the width of the car and the expected reversing path in accordance with the steering wheel position.

A superimposed central broken line indicates the centre of the car to facilitate parking manoeuvres or tow hook alignment. The various coloured areas indicate the distance from the rear of the car.

The table below shows the approximate distances for each area fig. 210:

Area	Distance from the rear of the vehicle
Red	0 - 1 ft (0 - 30 cm)
Yellow	1 - 3,3 ft (30 cm - 1 m)
Green	3,3 ft (1 m) or more

WARNING When parking, take the utmost care over obstacles that may be above or under the operating range of the camera.



WARNING

161) Parking and other potentially dangerous manoeuvres are, however, always the driver's responsibility. While carrying out these manoeuvres, always make sure that no people (especially children) or animals are in the area concerned. The camera is an aid for the driver, but the driver must never allow his/her attention to lapse during potentially dangerous manoeuvres, even those executed at low speeds. Always keep a slow speed, so as to promptly brake in the case of obstacles.



IMPORTANT

67) It is vital, for correct operation, that the camera is always kept clean and free from any mud, dirt, snow or ice. Be careful not to scratch or damage the camera while cleaning it. Avoid using dry, rough or hard cloths. The camera must be washed using clean water, with the addition of vehicle shampoo if necessary. In washing stations which use steam or high-pressure jets, clean the camera quickly, keeping the nozzle more than 10 cm away from the sensors. Also, do not apply stickers to the camera.

REFUELLING THE CAR

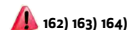

162) 163) 164)

Always stop the engine before refuelling.

PETROL ENGINES

Only use unleaded petrol with an octane number (R.O.N.) not lower than 95 (EN228 specification).

DIESEL ENGINES

Only use Diesel fuel for motor cars (EN590 specification).

REFUELING PROCEDURE

The fuel flap is unlocked when the central door locking system is released, while it is automatically locked when the central locking system is applied.

Opening the flap

To refuel proceed as follows:

- ❑ open flap (1) fig. 211, pressing on the point shown by the arrow fig. 212;
- ❑ remove the closing cap (2);
- ❑ return the cap to its seat (4);
- ❑ introduce the nozzle in the filler and refuel;
- ❑ once refuelling is complete, before removing the fuel nozzle, wait at least 10 seconds to allow the fuel to flow into the tank;
- ❑ then remove the dispenser from the filler, close the cap and then close the flap.

The refuelling procedure described above is illustrated on the label (where provided) located inside the fuel flap.

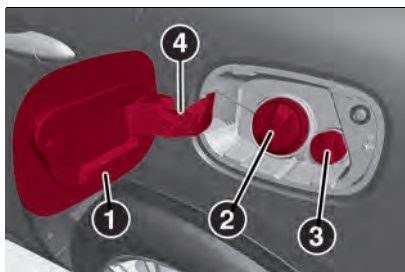

211

07226V0042EM



212

07206V0001EM

TOPPING UP AdBlue® DIESEL EMISSIONS ADDITIVE

(2.2 JTD versions only)



Preliminary Conditions

AdBlue® freezes at temperatures lower than 12.2°F (-11 °C). If the car stands for a long time at this temperature refilling could be difficult. For this reason, it is advised to park the car in a garage and/or heated environment and wait for the AdBlue® to return to liquid state before topping up.

Proceed as follows:

- ❑ park the car on level ground;
- ❑ switch off the engine by turning the ignition device to STOP;
- ❑ open the fuel flap A (1) fig. 214 and then unscrew and remove the cap (3) (blue) from the AdBlue® filler and put it in the stowing position provided (4).

Refilling with nozzles

You can fill up at any AdBlue® distributor.

Proceed as follows:

- ❑ insert the AdBlue® nozzle in the filler, start refilling and stop refilling at the first shut-off (the shut-off indicates that the AdBlue® tank is full). Do not proceed with the refilling, to prevent spillage of AdBlue®;
- ❑ extract the nozzle.

Refilling with containers

Proceed as follows:

- ❑ check the expiration date;
- ❑ read the advice for use on the label before pouring the content of the bottle into the AdBlue® tank;
- ❑ if systems which cannot be screwed in (e.g. tanks) are used for refilling, after the indication appears on the instrument panel display (see "Indicator lights and messages" chapter in the "Knowing the instrument panel" section), fill the AdBlue® tank with at least 1.1 UK gal (5 litres);
- ❑ if containers which can be screwed to the filler are used, the reservoir is full when the AdBlue® level in the container stops pouring out. Do not proceed further.



ABC

AdBlue® level display

The level of AdBlue® inside the tank can be viewed on the Connect system display fig. 213.

Proceed as follows:

- activate the "Vehicle Information" function pressing the appropriate widget on the Connect system display.
- press the graphic button 1 fig. 213: the level 2 of AdBlue® will appear on the display.

If the AdBlue® level is not in reserve, the message "OK" will appear on the display.

If the AdBlue® level is insufficient the message "KO" will appear on the display.

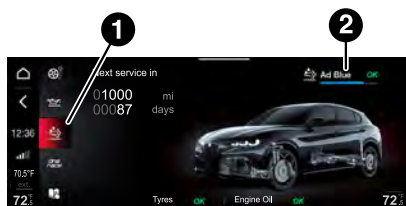

213

12126V2311EM

Operations after refilling

Proceed as follows:

- fit the cap (3) fig. 211 back on the AdBlue® filler by turning it clockwise and screwing it completely;

- set the ignition device to ON (it is not necessary to start the engine);
- wait for the indication on the instrument panel to switch off before moving the car. The indication may stay on for a few seconds to approximately half a minute. If the engine is started and the car is moved, the indication will remain on for longer. This will not compromise engine operation;
- if the AdBlue® was topped up when the tank was empty, see the "Refilling" chapter in the "Technical Specifications" section and wait for 2 minutes before starting the engine.

WARNING If AdBlue® is spilled out of the filler neck, clean up well the area and proceed to filling up again. If the liquid crystallises, eliminate it with a sponge and warm water.

WARNING

- **DO NOT EXCEED THE MAXIMUM LEVEL: this could cause damage to the reservoir. AdBlue® freezes under 12.2 °F (-11 °C). Although the system is designed to operate below the freezing point of the AdBlue®, it is advisable not to fill the tank beyond the maximum level because if the AdBlue® freezes the system can be damaged. Comply with the instructions provided in this paragraph.**

- **If the AdBlue® is spilled on painted surfaces or aluminium, immediately clean the area with water and use absorbent material to collect the fluid that has been spilled on the ground.**
- **Do not try to start the engine if the AdBlue® was accidentally added to the Diesel fuel tank, this can result in serious engine damage, contact a Alfa Romeo Dealership.**
- **Do not add additives or other fluids to AdBlue®, doing so could damage the system.**
- **The use of non-conforming or degraded AdBlue® may lead to indications appearing on the instrument panel display (see "Indicator lights and messages" chapter in the "Knowing the instrument panel" section).**
- **Never pour AdBlue® into another container: it could be contaminated.**
- **In case of damage to the sewage system of exhaust gas resulting from the use of additives / tap water, the introduction of diesel fuel, or at least by not fulfilling the requirements, the warranty expires.**
- **If the AdBlue® runs out, see the "Indicator lights and messages" chapter in the "Knowing the instrument panel" section to continue using the car normally.**

- ❑ The AdBlue® level is not updated if the car is parked on a sloping road.
- ❑ The consumption of AdBlue® emissions additive depends on the conditions of use of the car and is indicated by means of the symbol and a dedicated message on the instrument panel display.

Fuels - identification of vehicle compatibility. Graphic symbol for consumer information in accordance with EN16942

The symbols, shown below, make it easier to recognise the correct fuel type to use with your car.

Before refuelling, check the symbols (where provided) inside the fuel filler flap and compare them with the symbols shown on the fuel pump (where provided).

PETROL ENGINES

Inside the flap there is also the fuel type (UNLEADED FUEL = petrol) and the symbol (where provided) that certifies compliance with the EN228 (petrol) standard fig. 214.

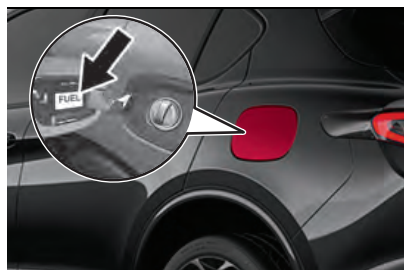

214

07206V0002EM

Symbols for petrol powered cars



E5: unleaded petrol containing up to 2.7% (m/m) oxygen and with maximum 5.0% (V/V) ethanol compliant with the EN228 specification.

E10: unleaded petrol containing up to 3.7% (m/m) oxygen and with maximum 10.0% (V/V) ethanol compliant with the EN228 specification.

DIESEL ENGINES

The fuel cap shows the type of fuel (DIESEL - diesel fuel) fig. 215, while inside the fuel flap there is the symbol (where provided) that certifies compliance with the EN590 standard.

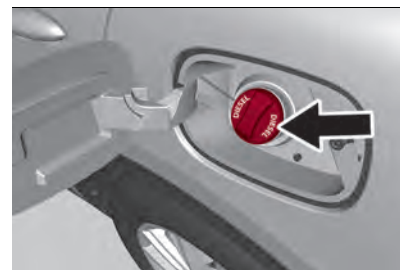

215

07206V0004EM

Symbols for diesel fuelled cars



B7: diesel containing up to 7% (V/V) of FAME (Fatty Acid Methyl Esters) compliant with the EN590 specification.

Emergency diesel version refuelling

Proceed as follows:

- ❑ open the boot and take out the dedicated adapter, located under the load platform fig. 216;
- ❑ open flap fig. 212, pressing on the point shown by the arrow;
- ❑ remove the closing cap;
- ❑ return the cap to its seat;
- ❑ insert the adapter into the filler;
- ❑ when you have finished refuelling, remove the adapter, close the cap and then close the flap;



ABC

- finally put the adaptor back in the boot.

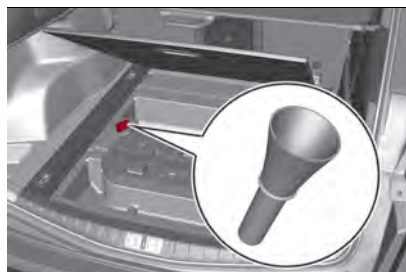

216

07206V0005EM

Emergency fuel flap opening

In the event of an emergency the fuel flap can be opened by operating from inside the boot.

Versions with Cargo Box

Proceed as follows:

- open the tailgate and then lift up the load bed fig. 217;
- lift the cover (1) fig. 218 to access the emergency opening cable (2) fig. 219, located by the side of the filler;
- pull the cable in the direction indicated by the arrow to release the fuel flap lock;
- open the fuel flap by pressing it.



217

04206V0004EM



218

07226V00041EM



219

07226V00043EM

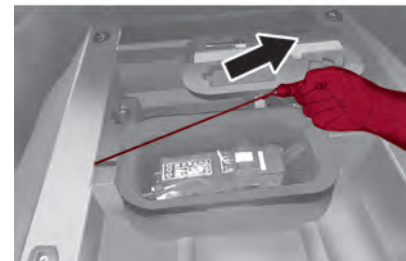

219

07226V00043EM

Versions with Cargo Box and space-saver wheel

(where provided)

Proceed as follows:

- open the tailgate and then lift up the load bed fig. 217;
- undo the locking device (1) fig. 220 and extract the space-saver wheel to reach the emergency opening cable (1) fig. 221 positioned on the side of the filler;
- pull the cord to unlock the fuel flap;

□ open the fuel flap by pressing it.

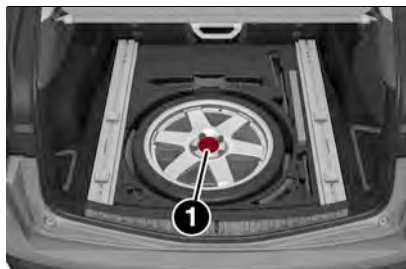

220

08066V0010EM



221

07226V0044EM

WARNING If the filler compartment is washed with a high-pressure jet, keep it at a distance of at least 20 cm.



WARNING

162) Do not apply any object/cap to the end of the filler which is not provided for the car. The use of non-compliant objects/plugs

could cause a pressure increase inside the tank, resulting in dangerous situations.

163) Do not approach naked flames or lit cigarettes to the fuel tank filler: fire risk. Keep your face away from the fuel filler to prevent breathing in harmful vapours.

164) Do not use a mobile phone near the refuelling pump: risk of fire.

165) If the AdBlue overheats for a prolonged period inside the tank to over 50 °C (for example, due to direct solar irradiation), the AdBlue may decompose and produce ammonia vapours. Ammonia vapours have a pungent odour when the cap of the AdBlue tank is unscrewed, therefore be careful not to inhale any ammonia vapours in the tank outlet. In this concentration, however, the ammonia vapours are not harmful or dangerous to health.

AdBlue® (UREA) ADDITIVE FOR DIESEL EMISSIONS

(2.2 JTD versions only)

The car is equipped with an AdBlue® (UREA) injection system and Selective Catalytic Reduction to meet emission standards.

These two systems ensure compliance with the diesel emissions requirements; at the same, they ensure fuel-efficiency, handling, torque and power. For messages and system warnings, refer to the "Warning lights and messages" chapter in the "Knowing the instrument panel" section.

AdBlue® (UREA) is considered a very stable product with a long shelf life. Stored at temperatures LOWER than 89.6°F (32°C), it has a shelf life of at least one year.

For more information on the AdBlue® (UREA) liquid type, see the "Fluids and Lubricants" chapter in the "Technical Specifications" section.

The car is provided with an automatic AdBlue® (UREA) system which, when the engine is running, allows the system to work correct at temperatures lower than 12.2°F (-11°C).

WARNING AdBlue® (UREA) freezes at temperatures lower than 12.2°F (-11°C).

DRIVING TIPS

SAVING FUEL

Below are some suggestions which may help you save fuel and thus lower the amount of harmful emissions released into the atmosphere.

Car maintenance

Checks and maintenance should be carried out in accordance with the "Service schedule" (see the "Maintenance and care" section).

Tyres

Check the tyre pressures at least once every four weeks: if the pressure is too low, consumption levels increase as resistance to rolling is higher.



ABC

Unnecessary loads

Do not travel with an overloaded boot. The weight of the car and its arrangement greatly affect fuel consumption and stability.

Electric devices

Use electrical devices only for the amount of time needed. The heated rear window, additional headlights, screen wipers and heater fan require a considerable amount of energy; increasing the current uptake increases fuel consumption (by up to +25% in an urban cycle).

Climate control system

Using the climate control system will increase consumption: use standard ventilation when the temperature outside permits.

Devices for aerodynamic control

The use of non-certified devices for aerodynamic control may adversely affect air drag and consumption levels.

DRIVING STYLE**Start**

Do not warm up the engine at low or high revs when the car is stationary; this causes the engine to warm up more slowly, thereby increasing fuel consumption and emissions. It is therefore advisable to move off immediately, slowly, avoiding high

speeds: in this way the engine will warm up more quickly.

Unnecessary actions

Avoid pressing the accelerator when stationary.

Gear selection

Use a high gear when traffic and road conditions allow it. Using a low gear for faster acceleration will increase fuel consumption. In the same way, improper use of a high gear increases consumption, emissions and engine wear.

Top speed

Fuel consumption considerably increases as speed increases. Maintain a constant speed, avoiding unnecessary braking and acceleration, which cost in terms of both fuel consumption and emissions.

Acceleration

Accelerating violently severely affects consumption and emissions: acceleration should be gradual and should not exceed the maximum torque.

CONDITIONS OF USE**Cold starting**

Short journeys and frequent cold starts do not allow the engine to reach optimum operating temperature. Consequently, both consumption (from +15 to +30% on the urban cycle) and emissions will increase.

Traffic and road conditions

High fuel consumption is caused by heavy traffic, for instance when travelling in a queue with frequent use of low gears or in cities with many traffic lights. Winding mountain roads and rough road surfaces also adversely affect consumption.

TRANSPORTING PASSENGERS**Warnings**

WARNING It is extremely dangerous to leave children in a parked car when the temperature outside is very high. The heat inside the passenger compartment may have serious, or even fatal, consequences.

WARNING Never travel in the internal load compartment. In the event of an accident, anyone inside the boot would be at greater risk of serious or even fatal injury.

WARNING Ensure that all the occupants of the car wear their seat belts correctly and that any children are positioned correctly on the dedicated child restraint systems.

TRANSPORTING ANIMALS

Deployment of the airbags may be dangerous for an animal on the front seat. It is therefore advisable to arrange animals on the rear seat inside dedicated cages restrained by the car's seat belts.

Bear in mind also that, in the event of a sudden braking or an accident, an inadequately restrained animal may be projected within the passenger compartment, risking injury to the animal itself and the other occupants of the car.

EXHAUST GAS

Adequate maintenance of the exhaust system represents the best protection against leaks of carbon monoxide into the passenger compartment.

Should an unusual noise from the exhaust system or the presence of exhaust gas in the passenger compartment be identified, or if the underbody or rear part of the car is damaged, have the entire exhaust system and adjoining bodywork areas checked to identify any components which are broken, damaged, worn or have moved from their correct fitting position. For these operations, contact an Alfa Romeo Dealership.

QV VERSION PERFORMANCE

For safe driving, it is essential, particularly during the first days of use, to get to know the car by driving carefully and gradually discovering its performance.

BRAKES



WARNING Water, ice and salt spread on the roads may deposit on the brake discs, reducing braking efficiency the first time the brakes are applied.

WARNING To obtain the maximum efficiency of the braking system, a bedding-in period of about 500 km is needed: during this period it is better to avoid sharp, repeated and prolonged braking.

The car braking system may optionally fit four carbon-ceramic material brake discs, one on each wheel.

In order to guarantee the maximum braking capacity for the first use, Alfa Romeo performs a "run-in" procedure for discs and pads directly at the factory.

The use of carbon-ceramic material brake discs guarantees braking features (better deceleration/pedal load ratio, braking distances, fading resistance) proportional to the dynamic features of the car in addition to considerably decreasing the unsprung component weight.

The materials used and the structural features of the system could generate anomalous noises which have absolutely no adverse effect on correct operation and reliability of the braking system.

Greater pressure may need to be applied to the brake pedal the first time to keep the same braking capacity in presence of condensation or salt on the braking surfaces, for example after washing or if the car is not used for a long time.

WARNING Given the high technological level of this system, any servicing on it must be performed by a Alfa Romeo Dealership which exclusively has the skills needed for the repair operations.

WARNING In case of intensive, high-performance use of the car, have the efficiency of the carbon-ceramic material braking system inspected as shown on the Service Schedule at an Alfa Romeo Dealership.

Overheating of the brakes

The braking system components may overheat when driving on mountain roads with steep gradients or during sporty use of the car. When this happens, there may be noise/vibrations while braking.

When you reach the destination, do not stop the engine immediately, but leave it idling for a few minutes to let the braking system components cool down and to lubricate the engine parts properly.

To make the car safe when it is parked, apply the safety provisions of the Highway Code before leaving the car:

engage P (Park) mode;



ABC

- ❑ position the wheels at full lock;
- ❑ engage the electric parking brake;
- ❑ when parked on a steep slope, place chocks or stones behind the wheels.

DRIVING ON RACE TRACKS

Before driving on a track using a racing style, it is necessary to:

- ❑ Attend a race track driving course.
- ❑ Check the liquid levels in the engine compartment. For more information, see the “Checking levels” chapter in the “Maintenance and care” section;
- ❑ Have the vehicle inspected at a Dedicated Alfa Romeo Dealership.

Remember that the car was not designed to be driven exclusive on the race track and that this use increases stress and component wear.

Preheating the carbon ceramic material brake discs

The brake discs must be warmed up to make them fully efficient. You are advised to perform the following procedure:

- ❑ brake nine times from 80 mph (130 km/h) to 20 mph (30 km/h) with deceleration equal to 0.7 g (the longitudinal acceleration value is shown on the instrument panel display by setting “Race” mode and selecting the “Performance” page) with 20 second

intervals between brake applications; keep the car at a speed comprised between 37 mph (60 km/h) and 60 mph (100 km/h) and do not brake for 240 seconds to allow the brakes to cool down;

- ❑ then brake three times from 230 mph (200 km/h) to 20 mph (30 km/h) with deceleration equal to 1.1 g (ABS operation) with 30 second intervals between brake applications; keep the car at a speed comprised between 37 mph (60 km/h) and 60 mph (100 km/h) and do not brake for 300 seconds to allow the brakes to cool down.



WARNING

166) After the car has been stopped for a long time in a very cold place (temperature below 0 °C), for the first five brakes, the carbon-ceramic braking system efficiency is not optimal, so you may need slightly more pressure on the brake pedal.

TOWING TRAILERS

(where provided)



For towing caravans or trailers the car must be fitted with an approved tow hook and an adequate electrical system. Should aftermarket installation be requested, this must be carried out by specialists.

Install any specific and/or additional door mirrors as specified by the Highway Code.

Remember that, when towing a trailer, steep hills are harder to climb, braking distances increase and overtaking takes longer depending on the overall weight of the trailer.

Engage a low gear when driving downhill, rather than constantly using the brake.

The weight the trailer exerts on the car tow hook reduces the car's loading capacity by the same amount. To make sure that the maximum towable weight is not exceeded (given in the vehicle registration document) account should be taken of the fully laden trailer, including accessories and luggage.

Do not exceed the speed limits specific to each country you are driving in, in the case of vehicles towing trailers. In any case, the top speed must not exceed 60 mph (100 km/h).

Any electric brake must be powered directly by the battery through a cable with a cross-section of no less than 0.004 in² (2.5 mm²).

In addition to the electrical branches, the car electrical system can only be connected to the supply cable for an electric brake and to the cable for an internal light for the trailer, not exceeding 15 W. For connections use the preset box with battery cable with cross-section no less than 0.004 in² (2.5 mm²).

WARNING The use of auxiliary loads other than external lights (e.g. electric brake) must take place with engine running.



WARNING

167) The ABS with which the car is equipped will not control the braking system of the trailer. Particular caution is therefore required on slippery roads.

168) Never modify the braking system of the car to control the trailer brake. The towing braking system must be completely independent of the vehicle's hydraulic system.

ELECTRICALLY DRIVEN TOW HOOK

The tow hook and the socket for connecting the trailer lights are fixed to each other and are located behind the

rear bumper fig. 222 when they are not in use.

During operation, the position of the whole device (hook plus electrical socket) is controlled by button (1) fig. 223 on the right-hand boot trim. The button must be pressed twice within 4 seconds.

Switching from non-use to use is only permitted if the electrical parking brake is applied or the gear lever is in position P and the tailgate is open.



222

07216V0100EM



223

07216V0101EM

There is a LED on the button (1) fig. 223, which may be in one of the following states:

❑ **LED off:** indicates that at least one of the above conditions is not met, or the trailer light wiring is connected to the socket;

❑ **Flashing LED (slow flashing):** indicates that the tow hitch is in motion;

❑ **LED flashing (rapid flashing):** indicates a failure of the tow hitch or that the system must be initialised (see the description in the following paragraph);

❑ **LED on fixed:** indicates that the tow hook can be moved.

Safe opening and closing of the tow hook is guaranteed by a protection system that can stop and reverse its movement when it encounters an obstacle while opening or closing.

WARNING When the tow hook is not in use, put it in the closed position.

System initialisation

If the tow hook is not correctly initialised, the LED on button (1) fig. 223 flashes quickly.

In this case it is sufficient to move the hook the button (1): the initialization will be performed automatically.

During the initialization procedure the tow hook will fully retract (if it was not previously retracted), then it will come



ABC

out of its seat and will end its stroke in the "fully extracted" position.

Tow hook failure

If, after pressing button (1) fig. 223, the LED on the button flashes quickly, the tow hitch will not move, since there is a fault: in this case, contact an Alfa Romeo Dealership to have the failure eliminated.



Have a flat tyre or a burnt-out bulb?

At times, a problem such as these may interfere with your driving experience.

The pages on emergencies can help you to deal with critical situations independently and calmly.

In an emergency, we recommend that you call the phone number found in the Warranty Booklet.

You can also use the universal, national or international freephone number to find your nearest Alfa Romeo Dealership.

IN AN EMERGENCY



HAZARD WARNING LIGHTS	190
SOS CALL AND ASSIST CALL	190
REPLACING A BULB	193
FUSES	196
CHANGING A WHEEL	196
TYRE REPAIR KIT	199
JUMP STARTING	203
FUEL CUT-OFF SYSTEM	206
ENGINE OVERHEATING	206
AUTOMATIC TRANSMISSION GEAR LEVER RELEASE	206
TOWING A BROKEN-DOWN CAR	206
TOWING THE CAR	207

HAZARD WARNING LIGHTS

CONTROL



Press hazard lights button fig. 224 to switch the hazard warning lights on/off.

When the hazard lights are on, the hazard warning lights  and  flash.

When you need to move away from the vehicle to look for help, the hazard warning lights will continue flashing even if the ignition device is in the STOP position.





224

08016V0001EM

WARNING The use of hazard warning lights is governed by the highway code of the country you are driving in: comply with legal requirements.

Emergency braking

The hazard lights are switched on and warning lights  and  appear on the instrument panel in case of emergency

braking and according to the mode selected by the "Alfa DNA™" selector.

When the "Alfa DNA™" selector is in position "n" or "a", the activation threshold of the hazard warning lights is higher; on the other hand, in position "d" the sensitivity of the activation is lower than that in the "n" and "a" modes.

The lights switch off automatically when emergency braking ceases. For further details about the emergency braking, see the "Active safety systems" chapter in the "Safety" section.



IMPORTANT

68) A prolonged use of the hazard warning lights may discharge the battery.

SOS CALL AND ASSIST CALL

(for versions/markets where provided)

The car is equipped with on-board assistance functions designed to provide support in the event of accident and/or emergency (SOS) or malfunctions of the vehicle (roadside assistance - ASSIST) managed by means of Alfa Connect Box.

The SOS function is activated:

- automatically in the event of a major collision recorded by the device aboard the car;
- manually, by pressing the SOS button located on the ceiling light fig. 225 or by means of the appropriate menu fig. 226 on the Connect system (for versions/markets, where provided).



225

0413650073EM

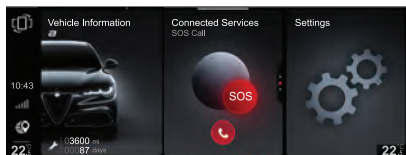

226

12126V2330EM

WARNING If the **SOS emergency service is activated, the call will be automatically routed to a private Call Centre. We hereby specify that, whenever the SOS call is referred to the text, the SOS call is to be considered managed by private service providers. This SOS call service is not the e-call service.**

The SOS service is valid for 5 years from delivery of the vehicle; in any case, it is advisable to consult the Connectivity section of the official Alfa Romeo website for updates on the terms of service.

The ASSIST function is activated:

- automatically (for versions/markets, where provided) following malfunctions of the braking system, fuel system, engine, etc.
- manually by selecting the appropriate menu fig. 227 on the Connect system (for versions/markets where provided).

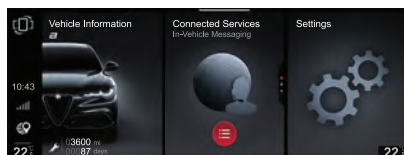

227

12126V2331EM

The SOS and ASSIST functions are active with:

- ignition device is at ON;
- ignition device in STOP position and Connect system display on.

After the SOS and ASSIST functions (for versions/markets, where provided) have been activated automatically or manually, pressing the corresponding button will send the position data to the operational centre and make a voice call to an operator.

NOTE If the SOS or Assist functions do not work, the fault in the system will be indicated on the display. Go as soon as possible to an authorised workshop to have the function repaired.

NOTE The correct operation of the SOS and ASSIST services will be guaranteed only by a good network coverage.

WARNING The SOS Call and ASSIST Call functions may not be available for the first minute after the car is started.

Privacy: GPS location is always active, for both SOS and Assist calls. Deactivating it via the menu items in the "Settings" menu of the Connect system will make some with other services unavailable (see the "Settings" chapter of the Connect system for more details).

WARNING The  icon is shown at the bottom left of the Connect system display when the geolocation function is active (ON). When geolocation is on, the vehicle position is tracked to enable the functions that require it. When geolocation is off, the vehicle position is only tracked by the navigation, safety, insurance and driver assistance systems (where provided). See the Connect system "Settings" chapter to deactivate the function.

MANUAL SOS CALL

In the event of need, hold the SOS button on the front ceiling light fig. 225 pressed for 2 seconds or press the button fig. 226 on the Connect display (for versions/markets where provided).

The SOS button located on the ceiling light will light up after connecting to an SOS operator and will turn off when the connection is ended.



ABC

NOTE If the SOS call button is pressed by mistake, it is possible to press it again within 10 seconds to cancel the operation or press the cancel button on the Connect system display.

Once the connection has been established, the following data will be automatically transmitted to the Operations Centre, as authorised by the customer:

- indication that the occupant has made an SOS call;
- the brand of the car;
- the most recent known GPS coordinates of the car.

If you are able to speak to the operator, do so through the car audio to provide additional information about the request for help.

If the system is unable to establish the voice call, or the line disconnects due to insufficient coverage, the SOS service will try to call the operational centre again for 5 minutes.

If the operational centre needs to contact the car again, the system can receive an incoming call, which will be accepted automatically.

WARNING Once the service has expired, you will not be put in contact with an operational centre and the system will alert you that the service is not available.

WARNING Any malfunctions detected by the SOS calling system will be notified:

- during the start-up phase;
 - when the malfunction is detected;
- by displaying a respective message on the Connect system display. Contact an Alfa Romeo Dealership as soon as possible.

WARNING In the event of danger (fire, visible smoke or hazardous road conditions or dangerous positions), do not wait for voice contact with the SOS service operator, but exit from the car immediately and go to a safe place, if in a condition to do so.

WARNING Do not place network antennas, CB radios or aftermarket electrical equipment to avoid interference. Such interference could prevent the system from making the emergency call.

WARNING Ignoring malfunction warnings displayed by the Connect system for a long time could lead to being unable to make an SOS call when needed.

Even if the SOS call system is fully functional, factors outside the control of FCA could interfere with or prevent operation of the SOS call. Such factors can be caused by the car electrical systems not being intact, damage to the SOS system during the accident,

obstructed or unavailable satellite signals, network congestion, adverse weather conditions, buildings, interfering structures, tunnels, etc.

ASSIST CALL

(for versions/markets where provided)

Pressing the graphic buttons fig. 227 located on the display of the Connect system makes a call to one or more of the following services:

□ **Roadside Assistance:** if case of need, a connection will be established with the roadside assistance authority which will receive the vehicle type and its position directly. Additional roadside assistance charges may apply.

□ **Customer Care** (for versions/markets, where provided): Customer service to provide support in case of problems to the car.

NOTE The relative menus and the Connect system status bar will change display state depending on the actions performed, and it will be possible to monitor each stage of the assist call (connection, duration, ending, connection errors, etc.).

NOTE If the ASSIST call button is pressed by mistake, the call can be ended by pressing the cancel button on the Connect system display.

Once the connection has been established, the following data will be

automatically transmitted, as authorised by the customer:

- indication that the occupant has made an ASSIST call;
- the brand of the car;
- the most recent known GPS coordinates of the car;
- the type of error that occurred on the car that automatically sent the ASSIST request (in the case of an automatic call - for versions/markets, where provided).

The call will be made through the car sound system to provide any additional information about the assistance request.

If the system is unable to establish the voice call, or the line disconnects due to insufficient coverage, the ASSIST service will try to call the Operations Centre again for certain number of times.

WARNING If you have not subscribed to the related services or the Roadside Assistance package has expired or is unavailable for purchase, the ASSIST call will not be available. For further information visit the Alfa Romeo official website.

WARNING If the ASSIST call system detects a malfunction, it is indicated by a corresponding message on the Connect system display. Contact an Alfa Romeo Dealership as soon as.

If an emergency call (SOS) is active and an ASSIST call is requested, the latter will not be delivered.

Alfa Connect Box SYSTEM BATTERY

The Alfa Connect Box system is provided with an independent battery that allows the operation of some connected services even if the car battery is disconnected.

The system will warn the user of the need to replace this battery by displaying a dedicated message on the display of the Connect system (for versions/markets where provided) and by means of a notification via mobile app (for versions/markets, where provided).

Go to an Alfa Romeo dealership as soon as possible.

NOTE Failure to replace the battery and, consequently, failure to observe the warnings provided by the system could affect or entirely prevent service operation.

NOTE Regardless of charge, the battery must be replaced every 5 years by an Alfa Romeo dealership.

REPLACING A BULB

FRONT AND REAR LIGHT CLUSTERS / DIRECTION INDICATORS / THIRD BRAKE LIGHT / LICENCE PLATE LIGHTS



WARNING When the weather is cold or damp or after heavy rain or washing the surface of headlights or rear lights may steam up and/or form drops of condensation on the inside. This is a natural phenomenon due to the difference in temperature and humidity between the inside and the outside of the glass which does not indicate an anomaly fault and does not compromise the normal operation of lighting devices. The mist disappears quickly when the lights are turned on, starting from the centre of the diffuser, extending progressively towards the edges.

REPLACING AN INTERNAL BULB

Courtesy mirror light fig. 228: lift the cover (1), remove the lens and replace the bulb (2), releasing it from the side contacts.



ABC

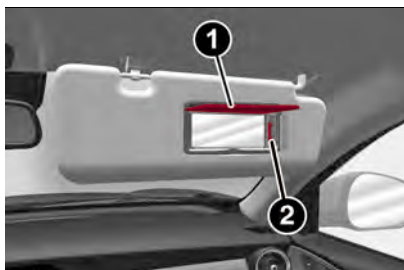

228

o8026V0008EM

Glove compartment ceiling light

fig. 229: remove the ceiling light at the point indicated by the arrow, open the cover and replace the lamp.

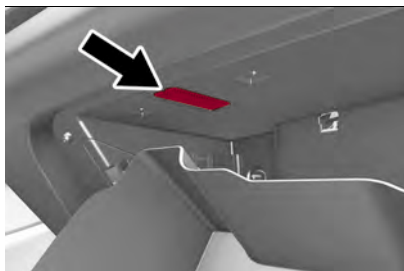

229

o8026V0009EM

Boot ceiling light fig. 230: act at the point indicated by the arrows, remove the ceiling light and replace the lamp.



230

o8026V0010EM

Puddle light on door panel fig. 231: act at the point indicated by the arrow, remove the ceiling light and replace the lamp.



231

o8026V0012EM



IMPORTANT



69) The number plate lights are of the LED-type. For bulb replacement, contact an Alfa Romeo Dealership.

Light bulbs	Type	Power
Sun visor light	1,5CP	2.1W
Glove compartment light	W5W	4W
Boot light	W5W	5W
Puddle lights (under door panel)	W5W	5W



ABC

FUSES

 169) 170)  70)



WARNING

169) Replacement of a fuse. Any service must be carried out exclusively by the Alfa Romeo Dealership or by a qualified repairer. The replacement of a fuse by a third party may cause a serious car fault.

170) Installation of electrical accessories. The vehicle's electrical circuit is designed to operate with standard or optional equipment, before installing other electrical equipment or accessories on the vehicle, contact the Alfa Romeo Dealership or a qualified repairer.



IMPORTANT

70) FCA declines all responsibility for expenses arising from the repair of the vehicle or for anomalies resulting from the installation of accessories not supplied or not recommended by Alfa Romeo and not installed according to specifications, in particular when the combined consumption of all the additional equipment connected exceeds 10 mA.

CHANGING A WHEEL

GENERAL INSTRUCTIONS

The car is equipped with the "Tire Repair Kit": see contents of the "Tire Repair Kit" chapter for how to use this device.

As an alternative to the "Tyre Repair Kit", the car may be requested with a space-saver wheel: see the instructions on the following pages for changing the wheel.

JACK

 171)

Please note that:

- the jack weighs about 4.4 lb (2 kg);
- the jack requires no adjustment;
- the jack cannot be repaired and in the event of a fault it must be replaced by another genuine one;
- no tool other than its cranking device may be fitted on the jack.

Jack maintenance:

- prevent any dirt from depositing on the "worm screw";
- keep the "worm screw" lubricated;
- never modify the jack.

Conditions in which not to use the jack:

- temperatures below -40°F (-40°C);
- on sandy or muddy ground;
- on uneven ground;
- on steep slopes in extreme weather conditions: thunderstorms, typhoons, hurricanes, blizzards, storms, etc.;

- in direct contact with the engine or for repairs under the car;
- on boats.

CHANGING PROCEDURE

 172) 173) 174) 175) 176)

 71) 72)

Proceed as follows:

- stop the car in a position that is not dangerous for oncoming traffic where you can change the wheel safely. The car must be stopped in a lay-by, car-park or parking or service area, and the ground must be as level as possible and sufficiently compact;
- stop the engine, engage the hazard warning lights and the electric parking brake and activate P (Park) mode;
- make sure that any passengers get out of the car and go to a safe place where they will not obstruct traffic or be exposed to the risk of injury. In the event of a puncture, change the tyre in accordance with the laws of the country in which you are travelling. Wear the reflective safety jacket (compulsory by law) before getting out of the car;
- open the luggage compartment and lift up the mat using the handle;
- when the situation dictates it (for your own safety and to comply with the regulations in force in the country where you are), take the warning triangle and

position it at a suitable distance from the car;

□ unscrew the locking device (1) fig. 232, take out the space-saver wheel and the inflation compressor;

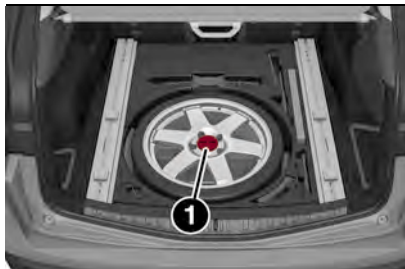

232

08066V0010EM

□ remove the damaged wheel by taking the wrench (3) fig. 233 and loosening the fixing bolts by about one turn. Shake the car to help detach the rim from the wheel hub;

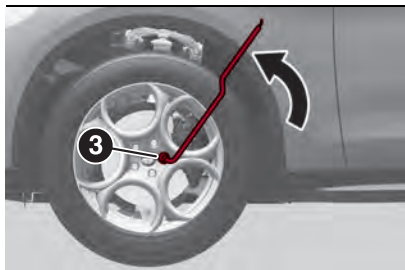

233

9490236

□ position the jack (4) fig. 234 under the car, near the wheel to be changed, taking care not to damage the plastic aerodynamic guard;

□ lift the extension lever (2) on the wrench (3);

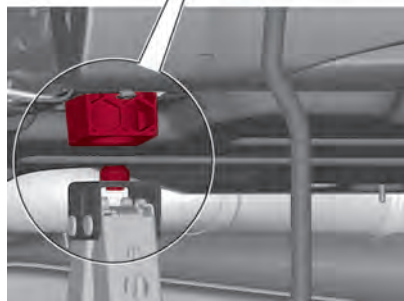
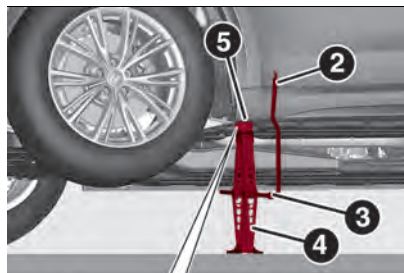

234

08066V0013EM

□ turn the extension lever (2) clockwise until the round pin on the jack engages in the hole in the lifting block located about 15 cm from the outside edge of the body. The lifting points (5) are shown in fig. 234

and are marked by a triangle ▽ on the aerodynamic guard fig. 235;

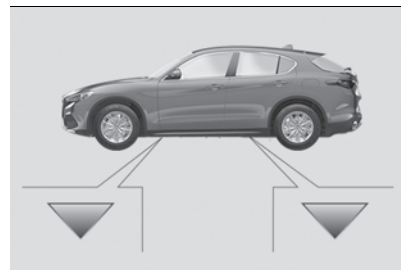

235

09056V0001EM

□ warn anybody nearby that the car is about to be raised;

□ they should stay clear and they should be warned not to touch the car until it is back on the ground;

□ turn the extension lever (2) until the wheel is a few centimetres off the ground;

□ remove the five wheel fastening bolts and take the wheel off;

□ make sure the contact surfaces between space-saver wheel and hub are clean so that the fastening bolts will not come loose;

□ fit the space-saver wheel by inserting the first bolt for two threads into the hole closest to the valve;

□ take the wrench (3) and fully tighten the fixing bolts;



ABC

❑ inflate the space-saver wheel. To do this, remove the cap from the inflation valve on the space-saver wheel and screw the compressor inflation hose fitting onto the Tire Repair Kit compressor (see the following pages);

❑ make sure that the switch on the Tire Repair Kit compressor is in the **OFF** position, and insert the plug into the power socket in the boot or passenger compartment (under the climate control panel), then start the engine and put the switch on the Tire Repair Kit compressor in the **ON** position;

❑ inflate the space-saver wheel to a pressure of 43.5 psi (3 bar);

WARNING To conserve the battery charge, you are advised to leave the engine running throughout the inflation process.

To obtain a more accurate reading, it is advisable to check the inflation pressure of the space-saver wheel on the Tire Repair Kit pressure gauge with the compressor off.

The compressor was designed exclusively for inflating the space-saver wheel. Do not use it for inflating mattresses, rafts, etc.

- ❑ operate the extension lever (2) fig. 234 on the jack (4) to lower the car;
- ❑ remove the jack (4);

❑ use the wrench (3), to fully tighten the bolts, passing alternately from one bolt to the opposite one.

When replacing an alloy wheel, it is advisable to place it upside down, with the aesthetic part facing upwards.



WARNING

171) *The jack is a tool developed and designed only for changing a wheel, if a tyre gets punctured or damaged, on the vehicle with which it is supplied or on other vehicles of the same model. Any other use, e.g. to jack up other vehicle models or different things, is strictly prohibited. Never use for maintenance or repair activities under the car or to exchange the summer/winter wheels and vice versa. Never go under the raised vehicle. Should it be necessary to work under the vehicle, contact an Alfa Romeo Dealership. Incorrect positioning of the jack may cause the raised vehicle to fall: use only in the positions indicated. Do not use the jack for loads higher than the one shown on its label. Never start the engine with vehicle raised. If the vehicle is raised more than necessary, everything can become more unstable, with the risk of the vehicle dropping violently. Thus, lift the vehicle only as needed in order to access the spare wheel.*

172) *Alert other drivers that the car is stationary in compliance with local regulations: hazard warning lights, warning triangle, etc. Any passengers on board should leave the car, especially if it is*

heavily laden. Passengers should stay away from on-coming traffic while the wheel is being changed. On hills or uneven roads, use chocks or appropriate objects to block the wheels of the vehicle.

173) *If left in the passenger compartment, the punctured wheel and jack constitute a serious risk to the safety of occupants in the event of accidents or sharp braking. Therefore, always place both the jack and punctured wheel in the dedicated housing in the boot.*

174) *It is extremely dangerous to attempt to change a wheel on the side of the car next to the driving lane: make sure that the car is at a sufficient distance from the road, to avoid being run over.*

175) *Never tamper with the inflation valve. Never introduce tools of any kind between the rim and the tyre. Check tyre and space-saver wheel pressures regularly, complying with the values given in the "Technical specifications" section.*

176) *The space-saver spare wheel is specific for your car. Do not use it on cars of different models. Do not use space-saver wheels of different models on your car. The space-saver wheel must only be used in the event of an emergency. Never use it for more than strictly necessary and never exceed 80 km/h. On the space-saver wheel there is an orange sticker, summarising the main warnings regarding space-saver wheel usage restrictions. Never remove or cover the label. Never apply any hubcap to the space-saver wheel. The car's driving characteristics will be modified with the space-saver wheel fitted. Avoid violent acceleration and braking, abrupt steering and fast cornering. Have the wheel repaired*

and refitted as soon as possible. Using two or more space-saver spare wheel at the same time is forbidden. Do not apply grease to the bolt threads before fitting: they could come unscrewed.



IMPORTANT

71) When turning the jack handle make sure that it can turn freely without scraping your hand against the ground. The moving components of the jack ("worm screw" and joints) can also cause injuries: avoid touching them. If you come into contact with lubricating grease, clean yourself thoroughly.

72) Contact an Alfa Romeo Dealership as soon as possible to have the correct tightening of the wheel bolts checked.

TYRE REPAIR KIT

(where provided)

 177) 178) 179) 180) 181) 182) 183) 184) 185) 186) 187) 188) 189)

 73) 74) 75)

 3)

The car may be equipped with a different Tyre Repair Kit (OPT1 kit or OPT2 kit), depending on the version.

The Tyre Repair Kit is located in the boot, inside a specific container.

To access the Tyre Repair Kit, open the boot, lift the load platform.

PRELIMINARY OPERATIONS

Proceed as follows:

- stop the car in a position that is not dangerous for oncoming traffic where you can carry out the procedure safely. The car must be stopped in a lay-by, car park or parking or service area, and the ground must be as level as possible and sufficiently compact;
- Stop the engine, turn on the hazard warning lights, engage the electric parking brake and set the gear lever to "P" (Park);
- steer the wheels completely;
- When parked on a steep slope, place a wedge or stone behind the wheels;
- Put on the reflective safety jacket before getting out of the car (if required by the regulations in force). In any case,

follow the road safety laws in force in the country where you are driving;

make sure that any passengers get out of the car and go to a safe place where they will not obstruct traffic or be exposed to the risk of injury. In the event of a puncture, change the tyre in accordance with the laws of the country in which you are travelling.

OPT1 KIT DESCRIPTION

The Tyre Repair Kit consists of:

- a spray can (1) fig. 236 of sealant, with filling tube (2);
- a compressor (4) complete with pressure gauge, fittings and an adhesive label (3) with the words Max. 80 km/h*, to be attached in a position easily visible to the driver (e.g. on the dashboard) after repairing the tyre;
- some adaptors, for inflating different elements.

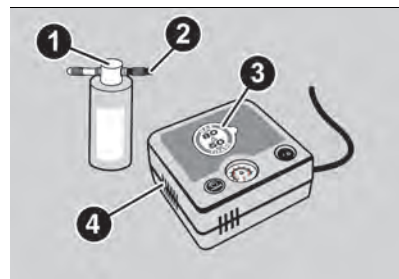

236

08066V0002EM



ABC

Inflation procedure

Proceed as follows:

- ❑ put on the gloves, connect the tube (5) fig. 237 to the spray can (1) using the connector (6). Unscrew the tyre valve cap and screw the filler pipe ring nut (2) onto the tyre valve;
- ❑ make sure that switch (7) fig. 238 on the compressor (4) is in the "0" (off) position;
- ❑ insert the plug into the socket in the boot and next start the engine;

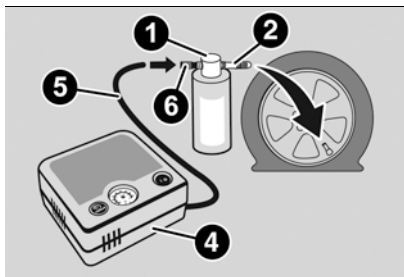

237

o8066V0004EM

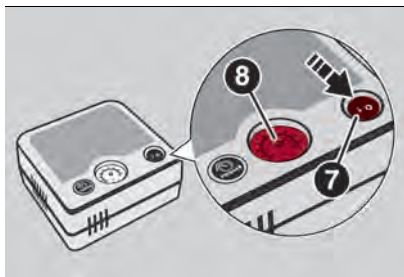

238

o8066V0005EM

- ❑ turn on the compressor by turning the switch (7) fig. 238 to the "I" (on) position;
- ❑ inflate the tyre to a pressure of at least 32 psi (2.2 bar). In order to obtain a more precise reading, check the pressure value on pressure gauge (8) fig. 238 with the compressor off;
- ❑ if a pressure of at least 26 psi (1.8 bar) is not reached within 15 minutes, the tyre is too damaged to be repaired; do not resume driving, but contact an Alfa Romeo Dealership;
- ❑ after having driven for about 5 miles (8 km), stop, engage the electric parking brake and recheck the tyre pressure;
- ❑ if the measured pressure is unchanged (32 psi / 2.2 bar), continue driving to an Alfa Romeo Dealership;
- ❑ if the measured pressure is between 19 psi and 30.5 psi (1.3 and 2.1 bar), restore pressure to 32 psi (2.2 bar), continue driving to an Alfa Romeo Dealership;
- ❑ if the measured pressure is lower than 19 psi (1.3 bar), the tyre is too damaged to be repaired. Do not continue driving, but contact an Alfa Romeo Dealership.

WARNING Only use original tyre repair cannisters, which can be purchased at an Alfa Romeo Dealership.

WARNING To conserve the battery charge, it is advisable to leave the engine running throughout the inflation process.

OPT2 KIT DESCRIPTION

The Tire Repair Kit consists of:

- ❑ (1) fig. 239 Pressure gauge
- ❑ (2) Instruction label
- ❑ (3) ON-FF switch

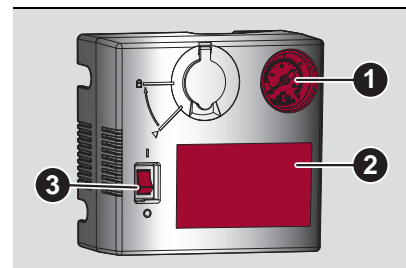

239

9550445

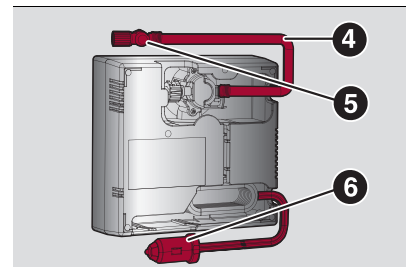

240

9550446

- ❑ (4) fig. 240 Air tube
- ❑ (5) Deflation button
- ❑ (6) 12V power supply cable/plug
- ❑ (7) fig. 241 Cap for the sealant bottle
- ❑ (8) Sealant bottle and expiry date

□ (9) Speed label

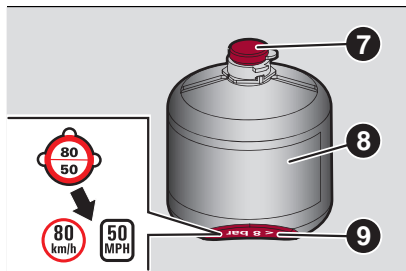

241

9550447

The kit comprises a compressor (1) fig. 242, one cartridge (2) containing sealant, and a sticker (3) with the words "Max 80 km/h" to be applied in a clearly visible position (e.g. on the dashboard or steering wheel) after repairing the tyre.

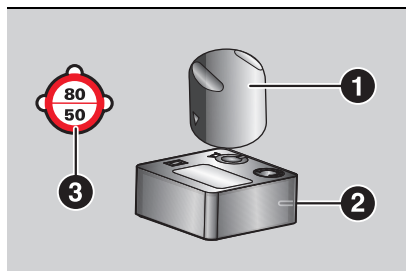

242

9550448

Repair procedure

Proceed as follows:

□ take the kit, detach the speed limit sticker (9) fig. 241 and apply it in a clearly

visible position, e.g. on the steering wheel fig. 243;

□ open the cap on the compressor, engage the cartridge and turn it one quarter turn clockwise fig. 244;

□ remove the cap from the tyre valve and screw the black compressor tube onto the valve;

□ ensure that the ON/OFF switch is in the "0" (off) position;

□ plug the electrical connector fig. 245 into the 12V socket in the car and then start the engine;

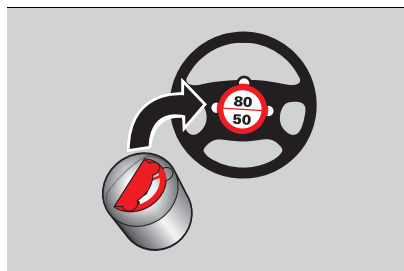

243

9550449

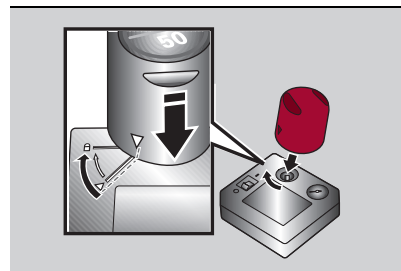

244

9550450

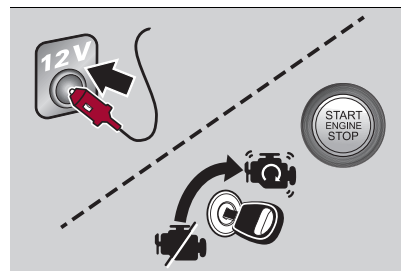

245

9550451

□ move the ON/OFF switch fig. 246 to the "I" (on) position to start the compressor;

□ when the pressure gauge indicates the prescribed pressure, move the ON/OFF switch to the "0" (off) position to stop the compressor.



ABC

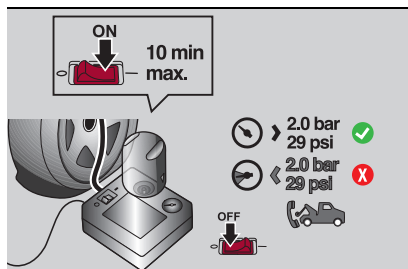

246

9550452

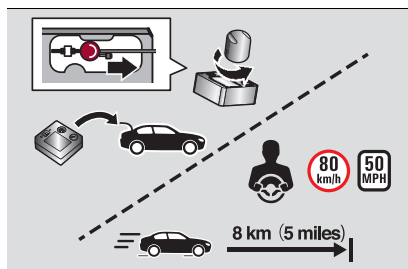

247

9550453

If the pressure gauge fig. 247 indicates a pressure lower than 2 bar / 29 psi 10 minutes after starting the compressor, switch off the compressor, disconnect the black compressor tube from the tyre valve, unscrew the cartridge by turning it anticlockwise by a quarter of a turn and lift it. Move the car by approximately 10 metres to allow the distribution of the sealant.

Stop safely, switch on the hazard warning lights, set the gear lever to P,

202

leave the wheels fully steered and then stop the engine. When parked on a steep slope, place a wedge or stone behind the wheels and restore the pressure to the prescribed value using the black compressor tube, fig. 247.

Also in this case, if the pressure is lower than 2.0 bar / 29 psi after 10 minutes from switching on the compressor, do not resume driving but contact an Alfa Romeo Dealer.

After driving for about 8 km / 5 miles, fig. 248, stop safely, switch on the hazard warning lights, set the gear lever to P, leave the wheels fully steered and then stop the engine. When parked on a steep slope, place a wedge or stone behind the wheels.

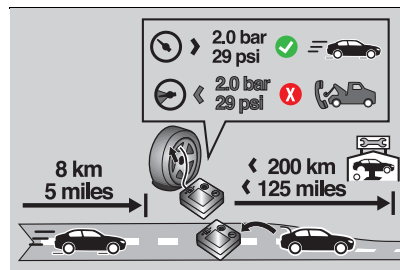

248

9550454

Take the compressor and restore the pressure using the black inflation tube. If the pressure shown is higher than 2.0 bar / 29 psi, restore the pressure and drive safely to an Alfa Romeo Dealership as

soon as possible. If the pressure is lower than 2.0 bar / 29 psi, do not resume driving but contact an Alfa Romeo Dealership.

Pressure relief valve

If the tyre pressure is higher than it should be, it can be lowered using the fig. 249 button near the black tube fitting after switching off the compressor.

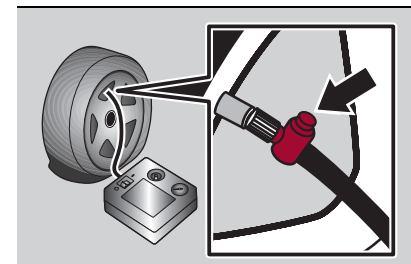

249

9550455



WARNING

177) ATTENTION: Do not exceed 80 km/h. Avoid sudden acceleration or braking. The Tyre Repair Kit provides a temporary repair, so the tyre must be examined and repaired by a specialist as soon as possible. Before using the Tyre Repair Kit, ensure that the tyre is not damaged excessively and that the rim is in good condition, otherwise do not use it and call roadside assistance. Do not remove foreign bodies from the tyre.

178) Punctures on the sides of the tyre may not be repaired. Do not use the Tyre Repair

kit if the tyre was damaged as a result of being used when underinflated.

179) Wear the protective gloves provided with the Tyre Repair kit.

180) Apply the sticker where it can be easily seen by the driver as a reminder that the tyre has been treated with the Tyre Repair Kit. Drive carefully, particularly on bends.

181) As required by current regulations, the information on chemical substances for the protection of human health and the environment and on the safe use of the sealing fluid are on the packaging label. Compliance with the indications on the label is an essential condition to ensure the safety and the effectiveness of the product. Remember to carefully read the label before use; the user of the product is responsible for any damages caused by improper use. The sealing fluid has an expiration date. Replace the bottle if the sealant has expired.

182) Repairs are not possible in the case of damage to the wheel rim (bad groove distortion causing air loss). Do not remove the foreign body (screws or nails) from the tyre.

183) The Tyre Repair Kit is not suitable for definitive repairs, so the repaired tyres may only be used temporarily. The Tirekit provides a temporary repair, therefore the tyre must be examined and repaired by a specialist as soon as possible.

184) Alert other drivers that the car is stationary in compliance with local regulations: hazard warning lights, warning triangle, etc. Any passengers on board should leave the car, especially if it is heavily laden. Passengers should stay away from on-coming traffic while the

wheel is being changed. On gradients or on unsurfaced roads, chock the wheels with the wedge provided.

185) If the pressure falls below 1.8 bar, do not drive any further: the Tyre Repair Kit cannot guarantee proper seal because the tyre is too damaged. Contact an Alfa Romeo Dealership.

186) Carefully read the cartridge label before use and avoid improper use. The kit should be used by adults and cannot be used by children.

187) You must always indicate that the tyre was repaired using the Tyre Repair Kit. Give the booklet to the technicians who will be handling the tyre that was treated using the Tyre Repair Kit.

188) Do not let the compressor turned on for longer than 10 consecutive minutes - overheating hazard

189) Use the kit only in case of a punctured tyre.



IMPORTANT

73) The sealant fluid is effective with external temperatures from -40°C to +50°C. The sealant fluid has an expiry date and must be replaced periodically.

74) The surface of the tube may be hot.

75) In the event of a puncture caused by foreign bodies, the kit may be used to repair tyres showing damage on the tyre tread up to max. 6 mm diameter.



IMPORTANT

3) Dispose of the bottle and the sealant liquid properly. Have them disposed of in compliance with national and local regulations.

JUMP STARTING

If the battery is flat, a jump starting can be performed using the battery and the cables of another car, or using an auxiliary battery. In all cases, the battery used must have a capability equal to or a little higher than the flat one.

Jump starting may be dangerous if carried out incorrectly: carefully follow the procedures described below.



WARNINGS

Do not use an auxiliary battery or any other source of external supply with a voltage above 12V: the battery, the starter, the alternator and the electrical system of the car could be damaged.

Do not attempt jump starting if the battery is frozen. The battery could break and explode!

REMOTE BATTERY CONNECTION POLES

To facilitate the operation, the remote poles of the battery for the jump starting can be found in the engine compartment:



ABC

the battery, on the other hand, is placed in the boot.

The negative terminal (-) fig. 250 is located next to the right bonnet catch.



250

o8076V0006EM

You can access the positive terminal (+) by lifting the protective flap fig. 251.

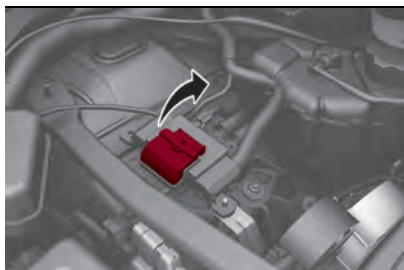

251

o8076V0002EM

The pole is shown in fig. 252.

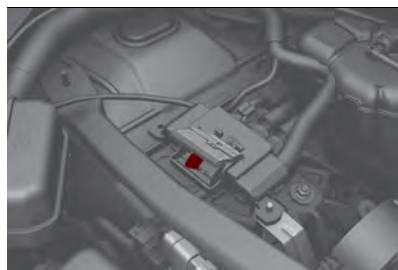

252

o8076V0001EM

QV version

The negative terminal (-) fig. 253 is located next to the right bonnet catch.

You can access the positive terminal (+) by lifting the protective flap fig. 254.

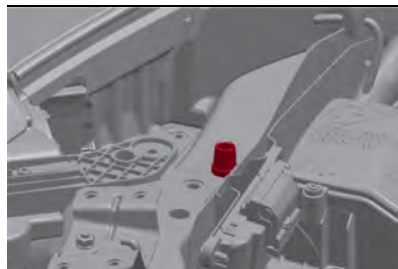

253

o8076V0003EM

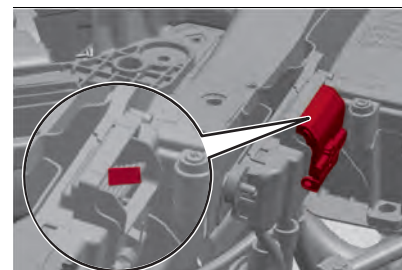

254

o8076V0007EM

To carry out the operation, you need to have the correct cables to connect the auxiliary battery to the remote poles of the flat battery.

Usually, these cables have terminals at the ends and are identified by different sheath colours (red = positive, black = negative).

STARTING WITH AUXILIARY BATTERY

 190) 191) 192)

Proceed as follows:

- switch off all electrical devices in the car;
- engage the parking brake, activate P (Park) mode and put the ignition device in the STOP position;
- should you be using the battery of another car, park the other car within the range of the cables used for the connection, operate the parking brake and ensure that its ignition is off.

WARNING If the auxiliary battery is installed on another car, check that there is no accidental contact of metal parts between the two cars, since an earth connection may result, with the risk of serious injury to any people who may be nearby.

WARNING If the procedure below is carried out incorrectly, it can cause severe injury to people or damage the recharging system of one or both cars. Carefully follow the instructions given below.

Cable connection



Proceed as follows to carry out a jump starting:

- ❑ connect a terminal on the end of the positive cable from the remote positive pole (+) of the car with flat battery;
- ❑ connect the terminal on the opposite end of the positive (+) cable to the positive (+) pole of the auxiliary battery;
- ❑ connect a negative cable end terminal to the negative (-) pole of the auxiliary battery;
- ❑ connect the terminal on the opposite end of the negative (-) cable to the earth point (-) on the car with the battery flat;
- ❑ start the engine of the car with an auxiliary battery, let it run for some minutes at idle and then start the engine of the car with flat battery.

In case a portable battery is used, before starting the car, wait a few seconds after completing the connection.

Cable disconnection

Once the engine is started, remove the connection cables in reverse sequence, as shown below:

- ❑ disconnect the negative cable end terminal (-) from the earth point (-) of the car with flat battery;
- ❑ disconnect the terminal on the opposite end of the negative cable from the negative (-) pole of the auxiliary battery;
- ❑ disconnect the terminal on the opposite end of the positive (+) cable from the positive (+) pole of the auxiliary battery;
- ❑ disconnect the terminal on the end of the positive cable from the remote positive pole (+) of the car with flat battery.



WARNING

190) Do not get too close to the radiator cooling fan: the electric fan may start; danger of injury. Scarves, ties and other loose clothing might be pulled by moving parts.

191) Remove any metal objects (e.g. rings, watches, bracelets), that might cause an

accidental electrical contact and cause serious injury.

192) The batteries contain acid that can burn skin or eyes. Batteries produce hydrogen, which is easily flammable and explosive. Thus keep away flames or devices which may cause sparks.



IMPORTANT

76) Never use a fast battery charger to start the engine as this could damage the electronic systems, particularly the engine ignition and fuel supply control units.

77) Do not connect the cable to the negative terminal (-) of the flat battery. The following spark could lead to battery explosion and cause serious harm. Only use the specific earth point; do not use any other exposed metallic part.



ABC

FUEL CUT-OFF SYSTEM

DESCRIPTION

Depending on the type and violence of the impact, the control unit of the ORC occupant protection systems determines whether to activate the airbags and the front seat belt pretensioners and whether to immediately interrupt the current from the batteries to the supply pumps and to the devices that operate the engine. The power from the battery is interrupted by "skipping" the pyrotechnic fuse placed on the fusebox next to the positive pole of the battery.

When the fuse is "skipped", only some services, necessary for the safety of the vehicle (e.g.: door locks, anti-theft device, etc.), remain powered.

WARNING After the impact, carefully check the vehicle for fuel leaks, for instance in the engine compartment, under the vehicle or near the tank area.

WARNING Contact an Alfa Romeo Dealership to have the system checked.

ENGINE OVERHEATING

WARNING An overheated cooling system can damage the car. In the case of overheating, pull over and stop the car. Keep the engine at idling with air conditioning off until the temperature decreases. If temperature does not decrease, contact an Alfa Romeo Dealership as soon as possible.

WARNING Coolant (antifreeze) exiting from the engine or vapour exiting from the radiator can cause serious burns. If vapour is seen or heard coming from the engine compartment, do not open the bonnet until the radiator has had enough time to cool down. Never try to remove the cap when the radiator is hot.

AUTOMATIC TRANSMISSION GEAR LEVER RELEASE

(where provided)

To release the automatic transmission lever, contact an Alfa Romeo Dealership.

TOWING A BROKEN-DOWN CAR

This chapter describes the conditions and methods to transport and tow a broken-down car with a breakdown truck.

The assistance car operators must be informed about the minimum ground clearance of the car in order to avoid contact between the ends of the bumper with the tow truck equipment.

The front and rear attachment corners of the car, to be taken into consideration when loading the car on the roadside assistance vehicle are shown in fig. 255.



255

949013

AWD versions

A: 21.7°

B: 18.3°

RWD versions

A: 20.6°

B: 18.8°

QV versions

A: 20.8°

B: 20°

REAR-WHEEL DRIVE (RWD) VERSIONS

It is recommended to tow the car with all four wheels lifted from the ground on the platform of a roadside assistance car.

If a tow truck with platform is not available, the car must be towed with the rear wheels LIFTED from the ground (using a trailer or special equipment allowing lifting of the rear wheels).

ALL-WHEEL DRIVE (AWD) VERSIONS

It is recommended to tow the car with all four wheels lifted from the ground on the platform of a roadside assistance car.

WARNING Avoid lifting the front (or rear) wheels only, using a trailer or car that allows lifting the wheels of one axle only. Lifting the front (or rear) wheels only while towing might damage the transmission or the transfer unit.

WARNINGS

If a car is towed without complying with the above requirements, the transmission and/or the transfer unit might be seriously damaged (on AWD

versions). Damage due to incorrect towing is not covered by warranty.

The car should be transported with all four wheels lifted from the ground on the platform of a roadside assistance car. Avoid towing with only the front (or rear) wheels lifted. When towing with only the front (or rear) wheels lifted, in addition to damaging the body, it could damage the gearbox.

To carry out the operation, the assistance car must be equipped with an appropriate movement/lifting equipment to avoid damaging the car. For loading on the towing car, attach the tow equipment to the main structural components of the car and not to the bumpers or other related brackets.

Comply with the regulations regarding assistance and car towing in force in each country.

When securing the car to a tow truck, do not attach to front or rear suspension components. Damage to your car may result from improper towing.

TOWING THE CAR

 (193) (194) (195)

In order to be able to tow the car, which has been in an accident or has broken down, on the road surface and only for short distances, a tow ring is provided in the tools container inside the boot.

Proceed as follows to use the tow ring:

- release the cap fig. 256 on the front or rear bumper (where provided) fig. 257, pressing on the upper part;
- take the tow hook from its housing in the boot and carefully clean the threaded housing on the car before using it;
- tighten the car's tow ring in its place for about 11 turns.



256

9490114



ABC



257

9490115

WARNING The largest work angle of the cable to fix on the tow ring must not exceed 15°, as shown in fig. 258.

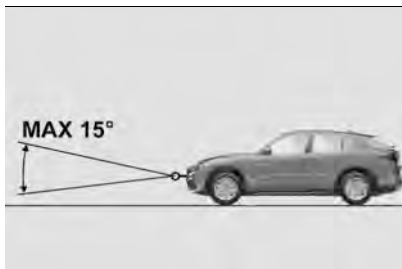

258

9490116

**WARNING**

193) Move the ignition device to ON and then to STOP, without opening the door.

194) The brake servo and the electromechanical power steering will not work while the vehicle is being towed. You will therefore need to apply more force on the brake pedal and steering wheel. Do not

use flexible ropes when towing, and avoid jerky movements. While towing, make sure that the trailer hitch does not damage any components it is touching. When towing the car, you must comply with all specific traffic regulations and adopt an appropriate driving behaviour. Do not start the engine while towing the car. Before tightening the ring, clean the threaded housing thoroughly. Make sure that the ring is fully screwed into the housing before towing the car.

195) The front and rear tow hooks should be used only for emergencies on the road. You are allowed to tow the vehicle for short distances using an appropriate device in accordance with the highway code (a rigid bar), to move the vehicle on the road in readiness for towing or transport via a breakdown vehicle. Tow hooks **MUST NOT** be used to tow vehicles off the road or where there are obstacles and/or for towing operations using cables or other non-rigid devices. In compliance with the above conditions, towing must take place with the two vehicles (one towing, the other towed) aligned as much as possible along the same centre line.



Proper maintenance allows car performance to be maintained over time, operating costs to be contained, and safety system performance to be safeguarded. This section explains how.

MAINTENANCE AND CARE

SCHEDULED SERVICING	210
ENGINE COMPARTMENT	220
RECHARGING THE BATTERY	227
SERVICING PROCEDURES	229
LIFTING THE VEHICLE	235
WHEELS AND TYRES	235
PROLONGED CAR INACTIVITY	237
BODYWORK	238
INTERIOR	239

SCHEDULED SERVICING

Correct servicing is crucial for guaranteeing a long life for the car under the best conditions.

For this reason, Alfa Romeo has planned a series of checks and maintenance operations at fixed distance intervals and, for versions/markets, where provided, at fixed time intervals, as described in the Service Schedule.

Before each scheduled service deadline, it is always necessary to carefully follow the instructions in the Service Schedule (e.g. periodically check level of fluids, tyre pressure, etc.).

Scheduled Servicing is offered by an Alfa Romeo Dealership according to a set time schedule. If, during each operation, in addition to the ones scheduled, the need arises for further replacements or repairs, these may be carried out with the owner's explicit consent only.

WARNING The scheduled service deadlines are set out by the Manufacturer. Failure to have them carried out may invalidate the New Vehicle Limited Warranty.

It is advisable to inform the Alfa Romeo Dealership of any small operating irregularities without waiting for the next scheduled service deadline.

PERIODIC CHECKS

Every year or **620 miles (1000km)** or before long journeys, check and top up, if necessary:

- engine coolant level;
- brake fluid level (if insufficient, see an Alfa Romeo dealership as soon as possible);
- AdBlue® (UREA) diesel emissions additive (2.2 JTD versions only);
- windscreen washer fluid level;
- tyre inflation pressure and condition;
- operation of lighting system (headlights, direction indicators, hazard warning lights, etc.);
- operation of windscreen washer/wiper system and positioning/wear of wiper blades.

Oil consumption of the engine depends on conditions and driving style. For this reason, the engine oil level must be checked every **1860 miles (3000 km)**, and topped up, if necessary (see the "Engine compartment - Checking the levels" chapter for information on the quantity to be topped up).

DEMANDING USE OF THE CAR

If the car is used in one of the following conditions:

- dusty roads;

- short, repeated journeys (less than 4-5 miles or 7-8 km) at sub-zero outside temperatures;

- engine often idling or driving long distances at low speeds or long periods of inactivity;

- in the event of a long period of inactivity;

the following checks must be carried out more often than indicated in the Service Schedule:

- check front and rear disc brake pad condition and wear;

- check cleanliness of bonnet and boot locks, cleanliness and lubrication of linkage;

- visually inspect conditions of: engine, gearbox, transmission, pipes and hoses (exhaust/fuel system/brakes) and rubber elements (gaiters/sleeves/bushes, etc.);

- check battery charge and battery fluid level (electrolyte);

- visually inspect conditions of the accessory drive belts;

- check and, if necessary, change engine oil and replace oil filter;

- check and, if necessary, replace the pollen filter;

- check and, if necessary, replace air cleaner;
- check and, if necessary, replace the Bad Fuel filter (where provided).



ABC

SCHEDULED SERVICING PROGRAMME (2.9 V6 engine)

WARNING Once you have carried out the last intervention in the table, continue with the scheduled servicing, maintaining the frequency indicated in the plan by marking each operation with a dot or dedicated note. Warning: simply restarting the maintenance from the start of the plan may cause the allowed interval to be exceeded for some operations!

Thousands of miles	9	18	27	36	45	54	63	72	81	90
Thousands of kilometres	15	30	45	60	75	90	105	120	135	150
Years	1	2	3	4	5	6	7	8	9	10
Check battery state of charge with the proper instrument	●	●	●	●	●	●	●	●	●	●
Check tyre conditions/wear and adjust pressure, if necessary. Check Tire Repair Kit condition/expiry	●	●	●	●	●	●	●	●	●	●
Check operation of lighting system (headlights, direction indicators, hazard warning lights, boot, passenger compartment, glove compartment, instrument panel warning lights, etc.)	●	●	●	●	●	●	●	●	●	●
Check and, if necessary, top up fluid levels in engine compartment (engine oil, windscreen washer, etc.) (1)	●	●	●	●	●	●	●	●	●	●
Check the supply/engine management systems operation using the diagnosis equipment	●	●	●	●	●	●	●	●	●	●
Visually inspect condition of: exterior bodywork, underbody protection, pipes and hoses (exhaust, fuel system, brakes), rubber elements (gaiters, sleeves, bushes, etc.)		●		●		●		●		●
Check windscreen and rear window wiper blade position/wear	●		●		●		●		●	
Check operation of the windscreen wiper/washer system and adjust nozzles, if necessary	●		●		●		●		●	

Thousands of miles	9	18	27	36	45	54	63	72	81	90
Thousands of kilometres	15	30	45	60	75	90	105	120	135	150
Years	1	2	3	4	5	6	7	8	9	10
Check cleanliness of bonnet and luggage compartment locks, cleanliness and lubrication of linkage		●		●		●		●		●
Visually inspect conditions and wear of front/rear disc brake pads and operation of pad wear indicators	●	●	●	●	●	●	●	●	●	●
Visually inspect the surface and edge of the carbon-ceramic brake discs (where provided)	●	●	●	●	●	●	●	●	●	●
Visually inspect the condition and tensioning of the accessory drive belt(s)	●	●	●		●	●	●		●	●
Replace brake pads/carbon-ceramic brake discs (where provided)	(5)									
Change engine oil and replace oil filter	●	●	●	●	●	●	●	●	●	●
Replace Transfer Case oil (for AWD versions)								●		
Spark plug replacement				●				●		
Replace accessory drive belt/s	(2)									
Replace air cleaner cartridge (3)		●		●		●		●		●
Change the brake fluid	(4)									
Replace passenger compartment filter (3)	○	●	○	●	○	●	○	●	○	●



ABC

Thousands of miles	9	18	27	36	45	54	63	72	81	90
Thousands of kilometres	15	30	45	60	75	90	105	120	135	150
Years	1	2	3	4	5	6	7	8	9	10

Alfa Connect Box system battery replacement (where provided)

(6)

- (1) Only ever use the fluids shown in the handbook for topping up, and only after checking that the system is intact.
 - (2) Areas that are not dusty: the maximum mileage is 60,000 km. The belt must be replaced every 4 years, regardless of distance travelled. If the car is used in heavy conditions (dusty areas, particularly harsh weather conditions, very low or very high temperatures for extended periods, urban driving, long periods of idling), the maximum mileage is 30,000 km. The belt must be replaced every 2 years regardless of the mileage.
 - (3) If the car is used in dusty areas, this cleaner should be replaced every 15,000 km.
 - (4) The brake fluid must be changed every 2 years, regardless of the mileage.
 - (5) The actual interval for changing the brake pads and the carbon ceramic brake discs depends on the car usage conditions and is signalled by the warning light or message on the instrument panel. Use the diagnosis equipment to reset the warning light every time the discs are replaced.
 - (6) The battery in the Alfa Connect Box system must be replaced every 5 years, regardless of mileage.
- (o) Recommended operations
- (●) Mandatory operations

SERVICE SCHEDULE (2.0 T4 MAir engine)

WARNING Once you have carried out the last intervention in the table, continue with the scheduled servicing, maintaining the frequency indicated in the plan by marking each operation with a dot or dedicated note. Attention: simply restarting the maintenance from the start of the plan may cause the allowed interval to be exceeded for some operations!

Thousands of miles	9	18	27	36	45	54	63	72	81	90
Thousands of kilometres	15	30	45	60	75	90	105	120	135	150
Years	1	2	3	4	5	6	7	8	9	10
Check battery state of charge with the proper instrument	●	●	●	●	●	●	●	●	●	●
Check tyre conditions/wear and adjust pressure, if necessary. Check Tire Repair Kit condition/expiry	●	●	●	●	●	●	●	●	●	●
Check operation of lighting system (headlights, direction indicators, hazard warning lights, boot, passenger compartment, glove compartment, instrument panel warning lights, etc.)	●	●	●	●	●	●	●	●	●	●
Check and, if necessary, top up fluid levels in engine compartment (engine oil, windscreen washer, etc.) (1)	●	●	●	●	●	●	●	●	●	●
Check the supply/engine management systems operation using the diagnosis equipment	●	●	●	●	●	●	●	●	●	●
Visually inspect condition of: exterior bodywork, underbody protection, pipes and hoses (exhaust, fuel system, brakes), rubber elements (gaiters, sleeves, bushes, etc.)		●		●		●		●		●
Check windscreen and rear window wiper blade position/wear	●		●		●		●		●	
Check operation of the windscreen wiper/washer system and adjust nozzles, if necessary	●		●		●		●		●	
Check cleanliness of bonnet and luggage compartment locks, cleanliness and lubrication of linkage		●		●		●		●		●



Thousands of miles	9	18	27	36	45	54	63	72	81	90
Thousands of kilometres	15	30	45	60	75	90	105	120	135	150
Years	1	2	3	4	5	6	7	8	9	10
Visually inspect conditions and wear of front/rear disc brake pads and operation of pad wear indicators	●	●	●	●	●	●	●	●	●	●
Visually inspect the condition and tensioning of the accessory drive belt(s)	●	●	●		●	●	●		●	●
Change engine oil and replace oil filter	(2)									
Replace Transfer Case oil (for AWD versions)								●		
Spark plug replacement				●				●		
Replace accessory drive belt/s	(3)									
Replace air cleaner cartridge (4)			●			●			●	
Change the brake fluid	(5)									
Replace passenger compartment filter (4)	○	●	○	●	○	●	○	●	○	●
Alfa Connect Box system battery replacement (where provided)	(6)									

(1) Only ever use the fluids shown in the handbook for topping up, and only after checking that the system is intact.

(2) The engine oil and filter change frequency depends on the driving conditions and is signalled by a warning light or message on the instrument panel. In any cases, never exceed 1 year.

(3) Areas that are not dusty: the maximum mileage is 60,000 km. The belt must be replaced every 4 years, regardless of distance travelled. If the car is used in heavy conditions (dusty areas, particularly harsh weather conditions, very low or very high temperatures for extended periods, urban driving, long periods of idling), the maximum mileage is 30,000 km. The belt must be replaced every 2 years regardless of the mileage.

(4) If the car is used in dusty areas, this cleaner should be replaced every 15,000 km.

(5) The brake fluid must be changed every 2 years, regardless of the mileage.

(6) The battery in the Alfa Connect Box system must be replaced every 5 years, regardless of mileage.

(○) Recommended operations

(●) Mandatory operations

SERVICE SCHEDULE (2.2 JTD engine)

WARNING Once you have carried out the last intervention in the table, continue with the scheduled servicing, maintaining the frequency indicated in the plan by marking each operation with a dot or dedicated note. Attention: simply restarting the maintenance from the start of the plan may cause the allowed interval to be exceeded for some operations!

Thousands of miles	12	24	36	48	60	72	84	96	108	120
Thousands of kilometres	20	40	60	80	100	120	140	160	180	200
Years	1	2	3	4	5	6	7	8	9	10
Check battery state of charge with the proper instrument	●	●	●	●	●	●	●	●	●	●
Check tyre conditions/wear and adjust pressure, if necessary. Check Tire Repair Kit condition/expiry	●	●	●	●	●	●	●	●	●	●
Check operation of lighting system (headlights, direction indicators, hazard warning lights, boot, passenger compartment, glove compartment, instrument panel warning lights, etc.)	●	●	●	●	●	●	●	●	●	●
Check and, if necessary, top up the fluid levels in engine compartment (engine coolant, hydraulic clutch/brakes, windscreen washer, battery) (1)	●	●	●	●	●	●	●	●	●	●
Check the supply/engine control systems operation using the diagnostic socket	●	●	●	●	●	●	●	●	●	●
Visually inspect condition of: exterior bodywork, underbody protection, pipes and hoses (exhaust, fuel system, brakes), rubber elements (gaiters, sleeves, bushes, etc.)	●		●		●		●		●	
Check windscreen and rear window wiper blade position/wear	●		●		●		●		●	
Check operation of the windscreen wiper/washer system and adjust nozzles, if necessary	●		●		●		●		●	



ABC

Thousands of miles	12	24	36	48	60	72	84	96	108	120
Thousands of kilometres	20	40	60	80	100	120	140	160	180	200
Years	1	2	3	4	5	6	7	8	9	10
Check cleanliness of bonnet and luggage compartment locks, cleanliness and lubrication of linkage		●		●		●		●		●
Visually inspect conditions and wear of front/rear disc brake pads and operation of pad wear indicators	●	●	●	●	●	●	●	●	●	●
Visually inspect the condition and tensioning of the accessory drive belt(s)			●					●		
Visually inspect the toothed timing drive belt			●					●		
Check engine air cleaner	●	●	●	●	●	●	●	●	●	●
Change engine oil and replace oil filter	(2)									
Replace Transfer Case oil (for AWD versions)						●				
Replace accessory drive belt/s	(3)									
Replace toothed timing drive belt	(3)									
Replace air cleaner cartridge (4)			●			●			●	
Replace fuel filter cartridge (6)			●			●			●	
Change the brake fluid	(5)									
Replace passenger compartment filter (4)	○	●	○	●	○	●	○	●	○	●

Thousands of miles	12	24	36	48	60	72	84	96	108	120
Thousands of kilometres	20	40	60	80	100	120	140	160	180	200
Years	1	2	3	4	5	6	7	8	9	10

Alfa Connect Box system battery replacement (where provided)

(7)

- (1) Only ever use the fluids shown in the handbook for topping up, and only after checking that the system is intact.
 - (2) The actual interval for changing engine oil and replacing the engine oil filter depends on the car usage conditions and is signalled by the warning light or message on the instrument panel. In any case, it must never exceed 2 years. If the car is used mainly on urban routes or it runs on diesel fuel that does not meet the EN590 Specification, the engine oil and engine oil filter must be changed every year.
 - (3) Areas that are not dusty: the maximum mileage is 120,000 km. The belt must be replaced every 5 years, regardless of distance travelled. If the car is used in heavy conditions (dusty areas, particularly harsh weather conditions, very low or very high temperatures for extended periods, urban driving, long periods of idling), the maximum mileage is 60,000 km. The belt must be replaced every 4 years regardless of the mileage.
 - (4) If the car is used in dusty areas, this cleaner should be replaced every 20,000 km.
 - (5) The brake fluid replacement has to be done every two years, irrespective of the mileage.
 - (6) If the car runs on fuel with quality below the relevant European specification, this filter must be replaced every 20,000 km.
 - (7) The battery in the Alfa Connect Box system must be replaced every 5 years, regardless of mileage.
- (o) Recommended operations
 (●) Mandatory operations



ABC

ENGINE COMPARTMENT

CHECKING LEVELS

 196) 197)

 78)

Quadrifoglio Version - 2.9 V6 engine fig. 259

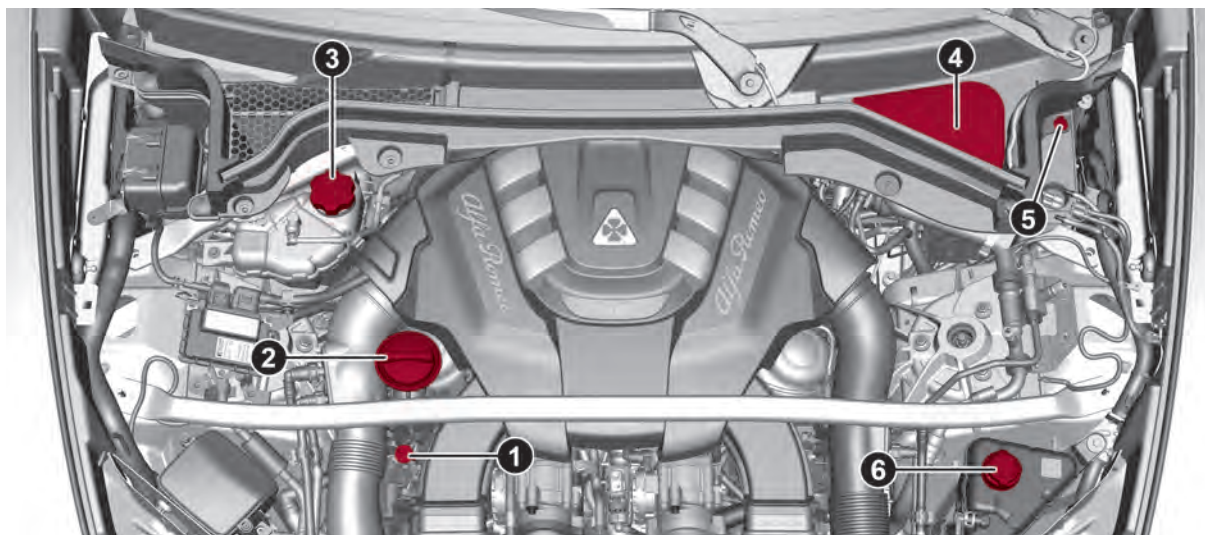

259

09016V0001EM

1. Engine oil level dipstick 2. Engine oil filler 3. Engine coolant reservoir cap 4. Windscreen washer fluid reservoir cap 5. Brake fluid reservoir plug access cover 6. Intercooler fluid reservoir cap



WARNING

196) Never smoke while working in the engine compartment: gas and inflammable vapours may be present, with the risk of fire.

197) Be very careful when working in the engine compartment when the engine is hot: you may get burned. Do not get too close to the radiator cooling fan: the electric fan may start; danger of injury. Scarves, ties and other loose clothing might be pulled by moving parts.



IMPORTANT

78) Be careful not to confuse the various types of fluids while topping up: they are not compatible with one another! Topping up with an unsuitable fluid could severely damage your vehicle.



ABC

2.0 T4 MAir engine fig. 260

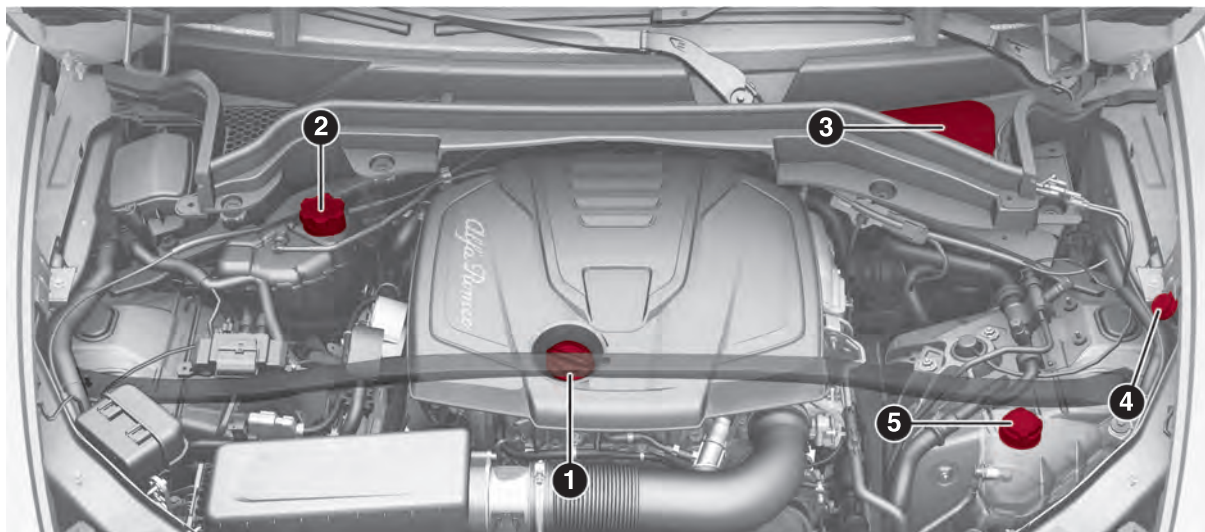

260

09026V0002EM

1. Engine oil filler 2. Primary engine cooling reservoir plug 3. Brake fluid reservoir plug access cover 4. Windscreen washer fluid reservoir cap 5. Secondary engine cooling reservoir plug

2.2 JTD Engine fig. 261

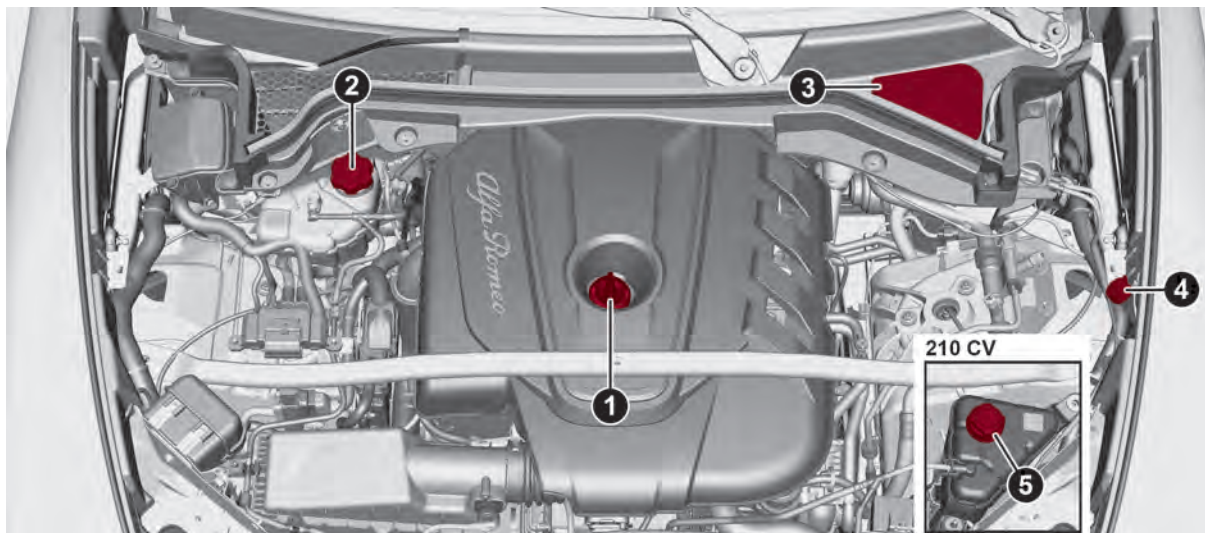

261

09026V0020EM

1. Engine oil filler 2. Engine coolant reservoir cap 3. Brake fluid reservoir plug access cover 4. Windscreen washer fluid reservoir cap 5. Secondary engine cooling reservoir plug



ABC

ENGINE OIL



198)



79)

WARNING It is advisable to check the engine oil level indication before long journeys.

The engine oil level can be seen on the instrument panel display every time the engine is started, or on the Connect system display using the "Vehicle Information" widget (see the Connect supplement for more information).

Use the 6 segments on the display to check that the oil level is between MIN and MAX level: 1 segment = MIN level, 6 segments = MAX level. If the oil level indication reaches the first red mark, add oil through the filler 1, considering that each notch shown on the display corresponds to approximately:

2.9 V6 Engine

□ 0.055 UK gal (250 ml)

2.0 T4 MAir engine

□ 0.055 UK gal (250 ml)

2.2 JTD Engine

□ 0.053 UK gal (200 ml)

If the  symbol and the corresponding message "Insufficient engine oil level" light up on the display of the instrument panel, top up 1 litre of engine oil as soon as possible.

In case of oil change or top-up, check the amount introduced using the dipstick. The level must NEVER be over the MAX line.

The oil level must be checked with the dipstick with the engine warm (temperature of about 194°F/ 90°C) after waiting 5 minutes.



80)

WARNING Make sure not to add too much engine oil when topping up. Engine oil in excess may damage the engine. Have the car checked. Never exceed the MAX level when topping up engine oil. It is advisable to check the oil level in intermediate steps on the instrument panel display. Use the oil dipstick on the QV version to check the level.

2.9 V6 engine: If the level is over the MAX line on the dipstick, go to a dedicated Alfa Romeo Dealership.

WARNING The oil level is not refreshed immediately on the display of the instrument panel after topping up. Consequently, wait for the oil level to be refreshed on the display following to procedure shown below.

Oil level manual checking procedure

2.9 V6 Engine

With the car level, check that the oil level is between the MIN and MAX marks on the dipstick (6). Take out the engine oil dipstick (6), clean it with a lint-free cloth

and reinsert it. Extract the dipstick again and check that the level is between the MIN and MAX marks on it.



80)

WARNING Make sure not to add too much engine oil when topping up. Engine oil in excess may damage the engine. Have the car checked. Never exceed the MAX level when topping up engine oil. It is advisable to check the oil level in intermediate steps using the oil that dipstick.

WARNING The oil level is not refreshed immediately on the display of the instrument panel after topping up. Consequently, wait for the oil level to be refreshed on the display following to procedure shown below.

WARNING The manual engine oil level checking procedure must be carried out, when necessary, on a cold engine only. Never attempt to carry out the manual engine oil checking procedure (using the dipstick) with the engine hot. Contact with the surrounding hot engine parts could cause burns.

2.0 T4 MAir and 2.2 JTD engines

Have this operation performed at an Alfa Romeo Dealership.

WARNING The oil dipstick in the engine compartment, on versions with 2.2 JTD engine, must be used ONLY if the oil level sensor is faulty. The latter condition is

indicated by the  symbol which will appear on the instrument panel.

Oil level indication update on display

If a top-up is needed, proceed as follows to ensure correct indication of the oil level on the display.

2.9 V6 Engine

Proceed as follows:

□ with the car level, run the engine for approximately 5 minutes (temperature of approximately 198°F/ 90°C) and then stop the engine;

□ wait for at least 5 minutes, turn the ignition switch in ON position without starting the engine and wait for a few seconds.

If the level indication is not updated after the previously described procedure, repeat the engine adjustment, stop the engine and wait a further 5 minutes before starting it again. If the indication is not updated after the second start, contact the dedicated Alfa Romeo Dealership.

WARNING In normal working conditions, the oil level indication is shown on the instrument panel display. In case of oil level sensor failure (condition indicated by the lighting of the  symbol on the instrument panel display), use the oil dipstick in the engine compartment EXCLUSIVELY for the time needed to restore correct operation of the oil level

sensor. The latter operation must be performed at a dedicated Alfa Romeo Dealership.

2.2 JTD Engine

Proceed as follows:

□ with the car level, run the engine until the third oil temperature notch lights on the display on the instrument panel, then stop the engine;

□ wait for at least 3 minutes, turn the ignition switch to ON without starting the engine and wait for 20 seconds.

Procedure for reading the engine oil level with the engine running and idling

Proceed as follows:

□ with the car stopped, parked on level ground, run the engine until the second oil temperature notch lights on the display on the instrument panel;

□ idle the engine and wait at least 1 minute for the correct reading.

2.0 T4 MAir engine

Proceed as follows:

□ with the car level, run the engine for approximately 5 minutes (temperature higher than 176°F (80°C)) and then stop the engine;

□ start the engine again and idle it for about 2 minutes.

WARNING If the indication is not correct after the procedure, contact an Alfa Romeo Dealership.

Engine oil consumption

 81)

 4)

The maximum engine oil consumption is usually 0.88 lb (400 grams every 620 miles (1000 km). When the car is new, the engine needs to be run in, therefore the engine oil consumption can only be considered stabilised after the first 3100 - 3700 miles (5000 - 6000 km).

ENGINE COOLANT

 199)

 82)

If the level is too low, unscrew reservoir cap and add the fluid described in the "Technical Specifications" section.

WINDSCREEN WASHER FLUID

 200) 201)

The windscreen fluid reservoir is equipped with a telescopic filler.

If the level is too low, lift the reservoir cap (4) fig. 262 upwards and then lift the filler, as shown in the figure, and add the fluid described in the "Technical Specifications" section.

After having topped up the fluid, arrange the filler correctly and then press on the cap until you hear it click.





262

0908650666EM

BRAKE FLUID

Check that the fluid is at the max. level.

If the liquid level in the tank is insufficient, contact an Alfa Romeo Dealership to have the system checked.

WARNING Contact an Alfa Romeo Dealership for any filling/replacement operation.

AUTOMATIC TRANSMISSION ACTIVATION SYSTEM OIL



The transmission control oil level should only be checked at an Alfa Romeo Dealership.

BATTERY

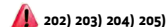

The battery does not require the electrolyte to be topped up with distilled water. A periodic check carried out at an Alfa Romeo Dealership is, however, necessary to check efficiency.

Useful advice for extending the life of your battery

To avoid draining your battery and make it last longer, observe the following instructions:

- when you park the car, ensure that the doors, boot and bonnet are closed properly, to prevent any lights from remaining on inside the passenger compartment;
- switch off all ceiling lights inside the car: the car is however equipped with a system which switches all ceiling lights off automatically;
- do not keep accessories (e.g. Connect system, hazard warning lights, etc.)

switched on for a long time when the engine is not running;

- before performing any operation on the electrical system, disconnect the negative battery cable.

If, after purchasing the car, you wish to install electrical accessories which require permanent electrical supply (e.g. alarm, etc.) or accessories which influence the electrical supply requirements, contact an Alfa Romeo Dealership, whose qualified staff will evaluate the overall electrical consumption.

WARNING If the battery was disconnected, do not start the engine immediately after reconnecting the terminals, but press the start button, without operating the pedals, to turn on the instrument panel and then start the engine.

WARNING If the charge level remains under 50% for a long time, the battery is damaged by sulphation, reducing its capacity and efficiency at start-up. The battery is also more prone to the risk of freezing (already at 14 °F / -10°C).

Replacing the battery

If necessary, replace the battery with another original battery with the same specifications. Follow the battery Manufacturer's instructions for maintenance.

WARNING It will not be possible to open the boot with a key or by pressing the button in the passenger compartment when the battery is disconnected. So, always extract the manual boot opening strap before disconnecting the battery. The procedure is described in the "Prolonged car inactivity" chapter this section.



WARNING

198) If the engine oil is being topped up, wait for the engine to cool down before loosening the filler cap, particularly for vehicles with aluminium cap (where provided). **WARNING:** risk of burns!

199) The cooling system is pressurised. If necessary, only replace the plug with another original or the operation of the system may be adversely affected. Do not remove the reservoir plug when the engine is hot: you risk scalding yourself.

200) Do not travel with the windscreen washer fluid reservoir empty: the windscreen washer is essential for improving visibility.

201) Some commercial additives for windscreen washer fluid are flammable. The engine compartment contains hot components which may start a fire.

202) Battery fluid is poisonous and corrosive. Avoid contact with the skin and eyes. Keep open flames away from the battery and do not use objects that might create sparks: risk of explosion and fire.

203) Using the battery with low fluid will irreparably damage the battery and may cause an explosion.

204) If the car must remain unused for a long time at a very low temperature, remove the conventional battery and take it to a warm place, to avoid freezing.

205) Always wear appropriate goggles to protect your eyes when working on or near the conventional battery.



IMPORTANT

79) The oil level must never exceed the MAX mark.

80) If the MAX mark is exceeded (last notch on the right turns red) after the top-up, go to an Alfa Romeo Dealership as soon as possible to have the oil in excess removed.

81) Always top up using engine oil of the same specifications as that already in the engine.

82) Use a fluid of the same type as that already present in the reservoir for any topping up of the engine cooling system. The fluid cannot be mixed with other types of antifreeze fluids. In the event of topping up with an unsuitable product, under no circumstances start the engine and contact an Alfa Romeo Dealership.

83) When you need to disconnect or remove the battery, do not close the boot. In order to avoid possible accidental closure, it is recommended to place an obstacle (e.g. a cloth) on the lock that would physically avoid closure.



IMPORTANT

4) Used engine oil and oil filters contain substances which are harmful to the environment. To change the oil and filters, we advise you to contact an Alfa Romeo Dealership.

5) Used transmission oil contains substances that may be dangerous for the environment. You are advised to contact an Alfa Romeo Dealership for oil changes.

6) Batteries contain substances which are very harmful for the environment. For battery replacement, contact an Alfa Romeo Dealership.

RECHARGING THE BATTERY

WARNINGS

 **206) 207)**

WARNING Before using the charging device, always make sure that it is appropriate for the installed battery, with constant voltage (below 14.8 V) and low amperage (maximum 15 A).

WARNING Recharge the battery in a well ventilated environment.

WARNING Never charge or recharge a frozen battery: it may explode because of the nitrogen trapped inside the ice crystals.

WARNING At all times while charging or recharging the battery, make sure



ABC

that any sparks or open flames are kept sufficiently far away from the battery. **WARNING** Before using any devices to charge or to maintain the charge of the battery, carefully follow the instructions provided with the device in order to properly and safely connect it to the car battery.

You can recharge the battery without disconnecting the wires of the vehicle's electrical system.

- ❑ To reach the battery, remove the load platform inside the luggage compartment fig. 263;



263

04206V0004EM

- ❑ remove the access cover fig. 264;

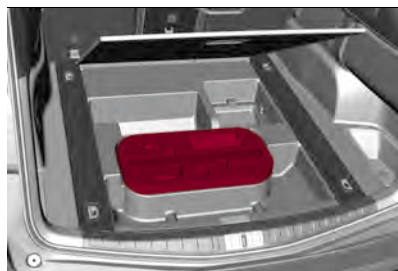

264

09036V0005EM

- ❑ remove the protective cover (1) fig. 265 and connect the positive cable terminal of the charger (usually red) to the positive terminal (+) of the battery;
- ❑ connect the terminal of the negative cable of the charger (usually black) to nut (2) next to the negative terminal (-) of the battery, as shown in fig. 265;

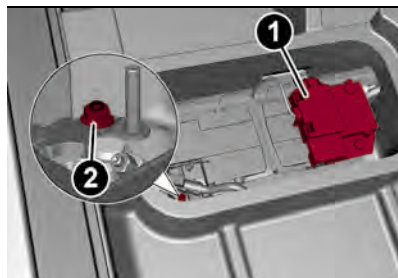

265

09036V0002EM

The vehicle is equipped with an IBS (Intelligent Battery Sensor), which is able to measure the charge and discharge voltage and calculate the charge level

and the general condition of the battery. The sensor is placed next to the negative terminal (-) of the battery.

For a correct charge/discharge procedure, the charge voltage must go through the IBS sensor.

- ❑ Turn the charger on and follow the instructions on the user's manual to completely recharge the battery;
- ❑ when the battery is charged, turn the charger off before disconnecting it from the battery;
- ❑ first disconnect the black cable terminal of the battery charger and then the red cable terminal;
- ❑ refit the protective cover of the positive terminal of the battery and the access cover to the battery compartment.

WARNING If a "quick-type" battery charger is used with the battery fitted on the vehicle, before connecting it disconnect both cables of the battery itself. Do not use a "quick-type" battery charger to provide the starting voltage.



WARNING

206) The process of charging or recharging the battery produces hydrogen, a

flammable gas that can explode and cause serious injury.

207) When charging or recharging the battery, always follow the precautions listed.



IMPORTANT

84) When you need to disconnect or remove the battery, do not close the boot. In order to avoid possible accidental closure, it is recommended to place an obstacle (e.g. a cloth) on the lock that would physically avoid closure.

SERVICING PROCEDURES

 208) 209) 210)

 85) 86) 87) 88) 89) 90) 84)

The following pages contain the rules on the **required** maintenance envisaged by the technical personnel who designed the car.

In addition to these specific maintenance instructions specified for routine scheduled servicing, there are other components which may require intervention or replacements over the car's life cycle.

ENGINE OIL

Engine oil level check

 87)

To ensure correct engine lubrication, the

oil must always be kept at the prescribed level (see the "Engine Compartment" chapter in this section).

Check the oil level at regular intervals, for example every 1860 miles (3000 km). It must be checked about 5 minutes after stopping the engine, once full operating temperature is reached. The car must also be parked on as level a surface as possible.

Ensure that the oil level is always between the minimum and maximum limits. *Quadrifoglio versions:* Ensure that the oil level is within the interval on the dipstick between the minimum and maximum limits.

The engine oil level can be checked using the Connect system.

To access the function, activate the main menu (MENU button) and select the following options in sequence: "Apps"; "Car Status"; "Oil Level".

Changing the engine oil

See the "Service Schedule" for the correct servicing intervals.

Choice of engine oil type

To ensure optimal performance and maximum protection in all operating conditions, it is advisable to use solely ACEA-certified engine oils (see description in "Fluid and lubricants"

chapter in the "Technical specifications" section).

Additives for engine oil

It is strongly recommended not to use additives (other than leak detection dyes) with the engine oil.

The engine oil is a product designed specially for the car and its performance may be deteriorated through the use of further additives.

Disposal of used engine oil and filters

For the disposal of the engine oil and filters, contact the appropriate body to determine local regulations.

WARNING Used engine oil disposed of incorrectly may seriously harm the environment.

ENGINE OIL FILTER

Replacing the engine oil filter

The engine oil filter must be replaced each time the engine oil is changed. It is advisable to replace it with a genuine spare part, specifically designed for this car.

AIR CLEANER

 208)

Replacing the air cleaner

See the "Service Schedule" for the correct servicing intervals. It is advisable to replace it with a genuine spare part, specifically designed for this car.



ABC

AIR CONDITIONING SYSTEM MAINTENANCE



92| 93|

To ensure the best possible performance, the air conditioning system must be checked and undergo maintenance at an Alfa Romeo Dealership at the beginning of the summer.

WARNING Do not use chemicals to clean the air conditioning system, since the internal components may be damaged. This kind of damage is not covered by warranty.

Replace the pollen filter

See the "Service Schedule" for the correct servicing intervals. For cleaner replacement, contact an Alfa Romeo Dealership.

LUBRICATING MOVING PARTS OF THE BODYWORK

Ensure that the locks and bodywork junction points, including components such as the seat guides, door hinges (and rollers), boot and bonnet are periodically lubricated with lithium-based grease to ensure correct, silent operation and to protect them from rust and wear.

Thoroughly clean the components, eliminating every trace of dirt and dust.

After lubricating, eliminate excess oil and grease. Also pay particular attention to the bonnet closing devices, to ensure

correct operation. During operations on the bonnet, to be carried out with the engine cold, also remember to check, clean and lubricate the locking, release and safety devices.

Lubricate the external lock barrels twice a year. Apply a small amount of high-quality lubricant directly into the lock barrel.

If necessary, contact an Alfa Romeo Dealership as soon as possible.

WINDSCREEN WIPER

Periodically clean the windscreen and rear window and rubber profile of the windscreen wiper blades, using a sponge or a soft cloth and a non-abrasive detergent. This eliminates the salt or impurities accumulated when driving.

Prolonged operation of the windscreen window wipers with dry glass may cause the deterioration of the blades, in addition to abrasion of the surface of the glass. To eliminate the impurities on the dry glass, always operate the windscreen washers.

In the event of very low outdoor temperatures, below zero degrees, ensure that the movement of the rubber part in contact with the glass is not obstructed.

Use a suitable deicing product to release it if required.

Avoid using the windscreen wipers to remove frost or ice.

Also avoid contact of the rubber profile of the blades with petroleum derivatives such as engine oil, petrol, etc.

WARNING The envisaged life of the windscreen wiper blades varies according to the usage frequency. In any case, it is advisable to replace the blades approximately once a year. When the blades are worn, noise, marks on the glass or streaks of water may be noticed. In the presence of these conditions, clean the windscreen wiper blades or, if necessary, replace them.

WARNING Driving with worn windscreen wiper blades is a serious hazard, because visibility is reduced in bad weather conditions.

Raising the windscreen wiper blades ("Service position" function)

The "Service position" function allows the driver to replace the windscreen wiper blades more easily. It is also recommended to activate this function when it is snowing and to make it easier to remove any dirt deposits in the area where the blades are normally positioned, when washing.

Activation of the function

To activate this function, deactivate the windscreen wiper (ring fig. 266 in

position **O**) before setting the ignition device to STOP.

This function can only be activated within 2 minutes of setting the ignition device to STOP.

To activate this function, move the lever upwards (unstable position) for at least three seconds.

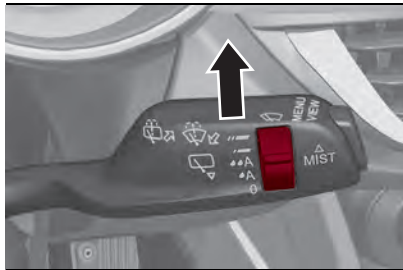

266

9490600

Function deactivation

The function is deactivated if:

- wait for longer than 2 minutes before turning the ignition device to the STOP position, after having raised the lever, and starting the Service procedure in this way;

- the ignition device is taken to position ON and the windscreen wiper control.

If, after using the function, the ignition device is set back to ON with the blades in a position other than rest position (at the base of the windscreen), they will only return to rest position following a

command given using the stalk (stalk upwards, into unstable position) or when a speed of 3 mph (5 km/h) is exceeded.

Replacing the windscreen/rear window wiper blades

Proceed as follows:

- raise the wiper arm, press tab fig. 267 of the attachment spring and remove the blade from the arm;

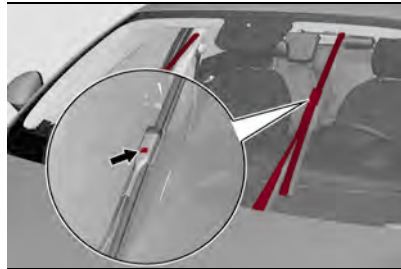

267

09046V0002EM

- fit the new blade, inserting the tab in the dedicated housing in the arm and checking that it is locked;

- lower the wiper arm onto the windscreen.

WARNING Do not operate the windscreen wiper with the blades lifted from the windscreen.

Windscreen / rear window washer

The screen washer jets fig. 268 are located on the windscreen wiper arms.

The rear screen washer jet is fixed fig. 269.

If there is no jet of fluid, firstly check that there is fluid in the reservoir (see paragraph "Engine compartment" in this chapter).



268

09046V0003EM

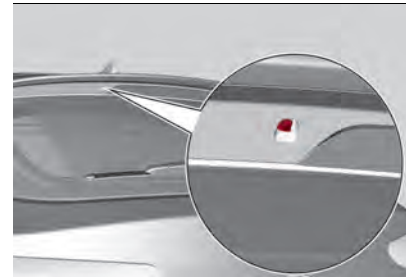

269

09046V0004EM

Then check that the nozzle holes are not clogged; use a needle to unblock them if necessary.

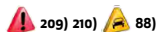

ABC

EXHAUST SYSTEM

Adequate maintenance of the engine exhaust system represents the best protection against leaks of carbon monoxide into the passenger compartment.

If an unusual noise from the exhaust or the presence of smoke in the passenger compartment is identified, or if the underbody or rear part of the car have been damaged, have the entire exhaust system and adjoining bodywork areas checked at an Alfa Romeo Dealership to identify any components which are broken, damaged, worn or have moved from their correct fitting position.

Open welding or loose connections may permit exhaust gas to enter the passenger compartment.

Have the exhaust system checked every time the car is raised.

Replace the components where necessary (for these operations, contact an Alfa Romeo Dealership).

In normal operating conditions, the catalytic converter does not require maintenance. To ensure that it operates correctly, however, and prevent it from getting damaged, it is extremely important that the engine operates perfectly.

To minimise the risk of damaging the catalytic converter, proceed as follows:

- do not stop the engine or deactivate the ignition device with gear engaged and car in motion;
- do not attempt to start the engine by bump starting;
- do not persist in using the car if idling is very irregular or the operating conditions are very notably irregular.

COOLING SYSTEM

Coolant (antifreeze) exiting from the engine or vapour exiting from the radiator can cause serious burns.

If vapour is seen coming from the engine compartment, or its hissing is heard, do not open the bonnet until the radiator has cooled.

WARNING Never attempt to remove the cap with radiator or expansion tank hot: **DANGER OF SCALDING!**

Engine coolant check

Check the engine coolant level every 620 miles (1000 km) or before long journeys.

If there are impurities in the engine coolant, the system must be drained, flushed and refilled: contact an Alfa Romeo Dealership.

Check the front part of the condenser to check for any build-up of insects, leaves or other debris.

Should it be dirty, clean it by spraying delicately with water.

Check the hoses of the engine cooling system to ensure that the rubber has not deteriorated and that there are no cracks, tears, cuts or obstructions in the expansion tank side and radiator side connectors. Should there be any doubt regarding leaks from the system (e.g. if frequent top ups are required), have the seal checked at an Alfa Romeo Dealership.

With the engine off and at normal operating temperature, check that the cooling system radiator cap is closed properly.

WARNING DO NOT remove the cap if the fluid is boiling: **DANGER OF SCALDING.**

WARNING Before removing the engine coolant reservoir cap, wait for the system to cool down.

Topping up / draining / flushing the engine coolant

If the engine coolant (antifreeze) is dirty, have cleaning and flushing carried out at an Alfa Romeo Dealership.

See the "Service Schedule" for the correct servicing intervals.

Warnings

- For topping up, use a fluid with the same characteristics as those indicated

in the "Fluids and lubricants" table (see "Technical specifications" chapter).

❑ Do not use pure water, alcohol-based coolants, corrosion inhibitors or additional anti-rust products because they may be incompatible with the engine coolant and cause the clogging of the radiator. The use of propylene glycol-based coolant is also not recommended.

Engine cooling system cap

To prevent loss of engine coolant, make sure that the expansion tank cap is closed. If it is open, screw it completely until you reach/hear the click.

Periodically check the cap and clean it from any foreign bodies that may have deposited on the external surface.

Warnings

- ❑ Never add coolant with the engine hot or overheated.
- ❑ Do not attempt to cool an overheated engine by loosening or removing the cap. The heat causes a considerable increase in pressure in the cooling system.
- ❑ To prevent damage to the engine, only use the engine cooling circuit caps provided.

Disposal of used engine coolant

Disposal of engine coolant is subject to legal requirements: contact the appropriate body to determine local regulations.

Warnings

- ❑ To prevent the fluid from being ingested by children or animals, do not keep it in open containers or pour it on the ground. If ingested, contact a doctor immediately. Eliminate any traces of fluid from the ground immediately.
- ❑ When the car stops after a short journey, vapour may be seen coming out from front of the bonnet. This is a normal phenomenon which is due to the presence of rain, snow or a lot of moisture on the surface of the radiator.
- ❑ With engine and system cold, do not top up with coolant beyond the maximum level indicated on the reservoir in the engine compartment.

BRAKING SYSTEM

To guarantee the efficiency of the braking system, periodically check its components: for this operation, contact an Alfa Romeo Dealership.

See the "Service Schedule" for the correct servicing intervals.

WARNING Driving with the pedal resting on the brake pedal may compromise its efficiency, increasing the risk of accidents. While driving, never keep your foot on the brake pedal and do not put unnecessary strain on it to prevent the brakes from overheating: excess pad wear may cause damage to the braking system.

Warnings

- ❑ When a low oil level is detected, contact an Alfa Romeo Dealership as soon as possible to have the system checked.
- ❑ Always keep the cap of the brake fluid reservoir (in the engine compartment) completely closed.

AUTOMATIC TRANSMISSION



Use only transmission oil with the same specifications as those indicated in the "Fluids and lubricants" table (see "Technical specifications" chapter).

Special additives

Do not use any type of additive with the automatic transmission oil. The automatic transmission oil is a product designed specially for this car and its performance may be compromised through the use of further additives.

Avoid the use of transmission sealers, since they may compromise the efficiency of the automatic transmission seals.

WARNING Do not use chemicals to flush the transmission, since this may damage its components.

Frequency of oil changes

In normal car operating conditions, it is not necessary to change the transmission fluid.



If fluid leaks are noticed or irregular operation of the transmission is detected, have it checked immediately at an Alfa Romeo Dealership.

WARNING Driving the car with an insufficient oil level may cause serious damage to the transmission.

REPLACING THE BATTERY

If necessary, replace the battery with another battery with the same specifications. It is advisable to contact an Alfa Romeo Dealership for replacement.

Follow the battery manufacturer's instructions for maintenance.

WARNING It will not be possible to open the boot with a key or by pressing the button in the passenger compartment when the battery is disconnected.

So, always extract the manual boot opening strap before disconnecting the battery. The procedure is described in the "Prolonged car inactivity" paragraph in this chapter.



91)



WARNING

208) The air intake system (air cleaner, rubber hoses, etc.) can be a protection in the case of blowbacks from the engine. **DO NOT REMOVE** this system unless you need

to carry out repair or maintenance. Before starting the engine, ensure that the system has not been removed: failure to observe this precaution may result in serious injury.

209) Exhaust emissions are very dangerous, and may be lethal. They contain carbon monoxide, a colourless, odourless gas which can cause fainting and poisoning if inhaled.

210) The exhaust system may reach high temperatures and may cause a fire if the car is parked on flammable material. Dry grass or leaves can also catch fire if they come into contact with the exhaust system. Do not park or use the car in a place in which the exhaust system might come into contact with flammable material.



IMPORTANT

85) Incorrect servicing of the car or failure to carry out operations or repairs (when necessary) may lead to more expensive repairs, damage to other components or have a negative impact on the car performance. Have any malfunction inspected immediately by an Alfa Romeo Dealership.

86) The car is filled with fluids which are optimised or protecting its performance and life and extending service intervals. Do not use chemicals for washing these components since they may damage the engine, the transmission or the climate control system. This damage is not covered by the car's warranty. If any component needs to be washed due to malfunctioning,

use only the specific liquid for that procedure.

87) An excessive or insufficient amount of oil inside the base is extremely damaging to the engine. Make sure it is always at an adequate level.

88) Vehicles equipped with catalytic converter must be fuelled only with unleaded petrol. Leaded petrol would permanently damage the catalytic converter and eliminate its ability to reduce polluting emissions, seriously compromising the engine performance, which would be irreparably damaged. If the engine does not work correctly, especially if it starts irregularly or if there is a reduction of its performance, immediately go to an Alfa Romeo Dealership. Prolonged and faulty operation of the engine may cause overheating of the converter and, as a consequence, possible damage to the converter and the car.

89) Using transmission fluid different from that approved may compromise the quality of gear changes and/or cause vibration of the transmission.

90) It is recommended to have the car serviced by an Alfa Romeo Dealership. When carrying out normal periodic operations and small servicing interventions personally on the car, it is recommended to use suitable equipment, genuine spare parts and the necessary fluids. Do not carry out any interventions if you do not have the necessary experience.

91) When you need to disconnect or remove the battery, do not close the boot. In order to avoid possible accidental closure, it is recommended to place an obstacle (e.g.

a cloth) on the lock that would physically avoid closure.

92) Always require the use of only compressor coolants and lubricants approved and suitable for the specific air conditioning system fitted on the car. Some non-approved coolants are flammable and may explode, with the risk of injuries. The use of non-approved coolants or lubricants may adversely affect system efficiency, leading to expensive repairs.

93) The air conditioner system contains coolant under high pressure: to avoid injuries to people or damage to the system, any coolant addition or repair that requires to disconnect the cables must be carried out by an Alfa Romeo Dealership.

LIFTING THE VEHICLE

If the car needs to be jacked up, go to an Alfa Romeo Dealership which is equipped with shop jacks and jack arms. The vehicle lifting points are marked on the side skirts with the symbols ▽ (see illustration in fig. 270).

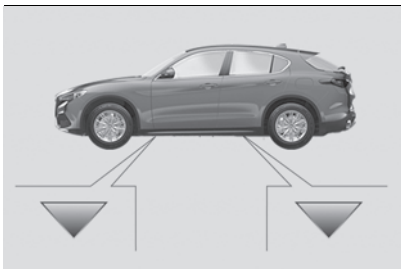

270

09056V0001EM

WHEELS AND TYRES

SAFETY INFORMATION

Before embarking on a long trip, and every two weeks, check the tyre inflation pressure. Check the tyres when cold.

It is normal for the pressure to increase when the vehicle is used due to tyre heating; for the correct tyre inflation pressure, see the "Rims and Tyres" paragraph in the "Technical specifications" chapter.

Incorrect pressure causes abnormal tyre wear fig. 271:

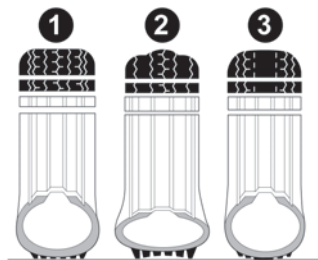

271

09066S0001EM

1 - normal pressure: tread evenly worn;

2 - low pressure: tread particularly worn at the edges;

3 - high pressure: tread particularly worn in the centre.

The tyres must be replaced when the tread reaches the minimum thickness reference on the tyres themselves.

GENERAL INFORMATION

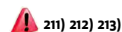

211) 212) 213)

Take the following precautions to prevent damage to the tyres:

avoid braking suddenly, racing starts and violent impact against the curb, potholes or other obstacles and driving for extended periods on uneven road surfaces;

periodically check that the tyres have no cuts in the side wall, abnormal swelling or irregular tread wear;

avoid travelling with the vehicle overloaded. If a tyre is punctured, stop immediately and change it;

every 6200/9300 miles (10000/15000 km) switch the tyres, keeping them on the same side of the vehicle in order not to change the rotation direction (if the tyres are the "one-way" type). Tyres with unidirectional tread can be recognised by arrows on the side of the tyre which indicate the direction of rotation. It is compulsory to comply with this direction. Only in this way can the tyres maintain their characteristics in terms of grip, noise, resistance to wear and drainage on wet surfaces;

tyres age even if they are not used much. Cracks in the tread and on the sidewalls are a sign of ageing. In any event, have the tyres checked by



ABC

specialised personnel if they have been fitted for longer than 6 years;
 □ in the case of replacement, always fit new tyres, avoiding those of unknown origin.

RIMS AND TYRES

For the type of wheel rims and tyres fitted on the vehicle see the "Rims and Tyres" paragraph in the "Technical data" chapter.

SNOW CHAINS



Rear Wheel Drive and All-wheel drive versions

It is possible to fit 0.5 in (13 mm) chains on all the tyres except for R20.

Quadrifoglio version

It is possible to put chains on the rear 285/40 R20 tyre (winter tyre size). Avoid using traditional chains as they can damage the braking system if not installed correctly, thereby compromising the car's safety.

We strongly advise using zero-clearance chains and to use equipment proposed by the Dedicated Alfa Romeo Dealership.

Warnings

The use of snow chains should be in compliance with local regulations of each country. In certain countries, tyres marked with code M+S (Mud and Snow) are considered as winter equipment;

therefore their use is equivalent to that of the snow chains.

The snow chains may be applied only to the rear wheel tyres.

Check the tension of the snow chains after the first few metres have been driven.

WARNING Using snow chains with tyres with non-original dimensions may damage the vehicle.

WARNING Using different size or type (M+S, snow, etc.) tyres between front and rear axle may adversely affect car driveability, with the risk of losing control of the car and resulting accidents.

SUGGESTIONS ABOUT THE ROTATION OF THE TYRES

The front and rear tyres are subject to different loads and stress due to steering, manoeuvres and braking. For this reason they are subject to uneven wear.

To resolve this problem, tyres should be rotated at the appropriate time (6,200/9,300 miles / 10000 / 15000 km). Inverting the tyres means moving them to different positions on the same side of the car (front to back and vice versa).

WARNING Crossing the tyres is not advised, so placing a tyre on a different axle on the other side of the car is impossible.

WARNING On cars equipped with differentiated tyres (tyre size different between front and rear axles, ex. QV version) rotation of any of the tyres is not advised.

Tyre rotation contributes to the preservation of the grip and traction performance on wet, muddy or snowy roads, guaranteeing optimal driveability of the vehicle.

In the case of irregular wear of the tyres identify the cause and correct it as soon as possible, by contacting an Alfa Romeo Dealership.

The suggested method for inverting the tyres is shown in fig. 272 (the arrow indicates the travel direction of the car).

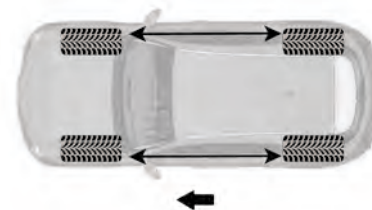

272

09066V0002EM

All-Wheel Drive (AWD) versions

It is recommended to avoid situations with a large difference in wear between the front and rear tyres and to strictly

use winter tyres of the sizes given in the “Rims and tyres provided” table.



WARNING

211) *The road holding qualities of the car also depend on the correct inflation pressure of the tyres.*

212) *If tyre pressure is too low, it may overheat and be severely damaged as a result.*

213) *Do not repaint alloy wheel rims at temperatures higher than 150°C. The mechanical features of the wheels could be compromised.*



IMPORTANT

94) *Keep your speed down when snow chains are fitted; do not exceed 50 km/h (or the equivalent in miles). Avoid potholes, do not drive over steps or pavements and do not drive long distances over roads without snow, to avoid damaging both your vehicle and the road surface.*

PROLONGED CAR INACTIVITY

If the vehicle is left inactive for longer than a month, the following precautions should be observed:

- ❑ park the car in covered, dry and if possible well-ventilated premises and slightly open the windows;
- ❑ check that the electric parking brake is not activated;
- ❑ disconnect the negative battery terminal and check the battery charge. Repeat this check once every three months during storage;
- ❑ if the battery is not disconnected from the electrical system, check its state of charge every thirty days;
- ❑ clean and protect the painted parts using protective wax;
- ❑ clean and protect the shiny metal parts using special compounds available commercially;
- ❑ sprinkle talcum powder on the windscreen wiper rubber blades and lift them off the glass;
- ❑ cover the vehicle with a fabric or perforated plastic sheet, paying particular care not to damage the painted surface by dragging any dust that may have accumulated on it.

Do not use compact plastic sheets which do not allow humidity to evaporate from the surface of the vehicle;

- ❑ inflate tyres to +7.2 psi (+0.5 bar) above the standard prescribed pressure and check it periodically;
- ❑ do not drain the engine cooling system;
- ❑ any time the car is left inactive for two weeks or more, operate the air conditioning system with engine idling for at least 5 minutes, setting external air and with fan set to maximum speed. This operation will ensure appropriate lubrication for the system, thus minimising the possibility of damage to the compressor when the system is operated again.

WARNING After setting the ignition device to STOP and having closed the driver side door, wait at least one minute before disconnecting the electrical supply from the battery. When reconnecting the electrical supply to the battery, make sure that the ignition device is in the STOP position and the driver side door is closed.



ABC

BODYWORK

BODY AND UNDERBODY WARRANTY

Your car is covered by warranty against perforation due to rust of any original element of the structure or bodywork. For the general terms of this warranty, refer to the Warranty Booklet.

PRESERVING THE BODYWORK

Paintwork

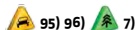

Touch up abrasions and scratches immediately to prevent the formation of rust.

Maintenance of paintwork consists of washing the car: the frequency depends on the conditions and environment where the car is used. For example, it is advisable to wash the car more often in areas with high levels of atmospheric pollution or salted roads.



To correctly wash the car, follow these instructions:

- ❑ if high pressure jets or cleaners are used to wash the car, keep a distance of at least 40 cm from the bodywork to avoid damage or alteration. Build up of water could cause damage to the car in the long term;
- ❑ in order to make it easier to remove any debris in the area where the brushes are normally placed, it is advised to put

vertically the windscreen wiper (Service Position). For more information refer to the "Maintenance procedures" chapter in this section;

- ❑ wash the bodywork using a low pressure jet of water if possible;
- ❑ wipe a sponge with a slightly soapy solution over the bodywork, frequently rinsing the sponge;
- ❑ rinse well with water and dry with a jet of air or a chamois leather.

Dry the less visible parts (e.g. door frames, bonnet, headlight frames, etc.) with special care, as water may stagnate more easily in these areas. Do not wash the car after it has been left in the sun or with the bonnet hot: this may alter the shine of the paintwork.

Exterior plastic parts must be cleaned in the same way as the rest of the car.

If you want to wash a car with automatic transmission in a car wash that moves it, you must do the following:

- ❑ make sure that the car is on a flat surface and that automatic engagement of the parking brake when the engine is switched off is disabled (for how to disable it, refer to the "Electric parking brake" chapter in the "Starting and driving" section);
- ❑ with the car stationary, the gear in N (Neutral) and the brake pedal up: press the start button. The car will remain in

N (Neutral) for 15 minutes, after which P (Park) mode will be activated.

Avoid parking under trees; the resin dropped by trees makes the paintwork go opaque and increases the possibility of corrosion.

Windows

Use specific detergents and clean cloths to prevent scratching or altering the transparency.

WARNING Wipe the rear window inside gently with a cloth following the direction of the filaments to avoid damaging the heating device.

Headlights

Use a soft cloth soaked in water and detergent for washing cars.

WARNING Never use aromatic substances (e.g. petrol) or ketones (e.g. acetone) for cleaning the plastic lenses of the headlights.

WARNING When cleaning the car with a pressure washer, keep the water jet at least 8 in (20 cm) away from the headlights.

ENGINE COMPARTMENT WASHING



If the engine compartment is washed (at low pressure, e.g. in very dusty areas), this must be done with the engine cold and with ignition device turned to STOP. Take care not to direct the water

jet straight at the electronic control modules or the wiper motors. Have this operation performed by a specialised workshop. After washing, check that the various protective components (e.g. rubber guards and caps) have not been removed or damaged.



IMPORTANT

95) In order to preserve the appearance of the paint abrasive products and/or polishes should not be used for cleaning the car.

96) Abrasive products and/or polishes should not be used for cleaning the car. Bird droppings must be washed off immediately and thoroughly as the acid they contain is particularly aggressive. Avoid parking the vehicle under trees (unless it is absolutely necessary). Remove any resinous plant matter immediately because, once it has dried, it may require the use of abrasive and/or polishing products to be removed, which are strongly discouraged as they could potentially alter the characteristics of the paintwork. Do not use pure windscreen washer fluid for cleaning the front windscreen and rear window; dilute it min. 50% with water. Only use pure screen washer fluid when strictly necessary due to outside temperature conditions. Do not use chemicals/acids to defrost windows/vehicle glass as they can damage the paint.

97) Avoid washing with rollers and/or brushes or a pressure washer with a high-pressure jet in washing stations. Wash the car only by hand using neutral

pH detergents; dry it with a wet chamois leather. Abrasive products and/or polishes should not be used for cleaning the car. Bird droppings must be washed off immediately and thoroughly as the acid they contain is particularly aggressive. Avoid (if at all possible) parking the car under trees; remove vegetable resins immediately as, when dried, it may only be possible to remove them with abrasive products and/or polishes, which is highly inadvisable as they could alter the typical opacity of the paint. Do not use pure windscreen washer fluid for cleaning the front windscreen and rear window; dilute it min. 50% with water. Only use pure screen washer fluid when strictly necessary due to external temperature conditions. Do not use chemicals/acids to defrost windows/vehicle glass as they can damage the paint.

98) A high pressure jet cleaner should not be used for cleaning the engine compartment. The appropriate precautions have been taken to protect all parts and connections, but the pressures generated by these devices are so high that complete protection against water seepages cannot be guaranteed.



IMPORTANT

7) Detergents pollute the water. The vehicle should be washed in areas equipped for collecting and purifying the liquid used in the washing process.

INTERIOR

 214) 215) 216) 217)

Periodically check the cleanliness of the interior, beneath the mats, which could cause oxidation of the sheet metal.

SEATS AND FABRIC PARTS

Use a specific product to clean carpets and fabric upholstery.

Remove dust with a soft brush or a vacuum cleaner.

It is advisable to use a moist brush on velvet upholstery. Rub the seats using a soft microfibre cloth moistened with a solution of water and neutral detergent.

Cleaning heat press images on seats
(where provided)

Due to the colour, opacity and wear-resistant protection with which the heat press images on some seat versions are made, they may be subject to temporary scratching if they are touched by finger nails, keys, or other hard objects.

In such cases, the visible signs do not impair the profiled images, and can easily be removed by wiping the affected area with a microfibre cloth moistened with water (not dry) to restore the seat to its original condition.

WARNING The microfibre cloth must not have been previously soaked in other substances or detergents.



ABC

LEATHER SEATS

(where provided)

Remove the dry dirt with a chamois or slightly damp cloth, without exerting too much pressure.

Remove any liquid or grease stains using an absorbent dry cloth, without rubbing. Then clean with a soft cloth or chamois leather dampened with water and mild soap. If the stain persists, use specific products and observe the instructions carefully.

WARNING Never use alcohol. Make sure that the cleaning products used contain no alcohol or alcohol derivatives, even in small quantities.

PLASTIC AND COATED PARTS



Clean interior plastic parts with a damp cloth (if possible made from microfibre), and a solution of water and neutral, non-abrasive detergent.

To clean oily or persistent stains, use specific products free from solvents and designed to maintain the original appearance and colour of the components.

Remove any dust using a microfibre cloth, if necessary moistened with water. The use of paper tissues is not recommended as these may leave residues.

ALCANTARA PARTS

(where provided)



Alcantara parts maintenance procedure:

- treat the surface with a microfibre cloth moistened with mild marseille soap and water, taking care to cover the entire covered area and applying a uniform light pressure (do not rub vigorously);
- rinse and wring out the microfibre cloth, and pass it again over the covered area treated according to the previous point;
- let it dry then brush gently with a soft brush.

LEATHER AND SOFT TOUCH PARTS

(where provided)

To clean these components, use a soft microfibre cloth moistened with a solution of water and neutral detergent. Before using a specific product for cleaning interiors, make sure that it does not contain alcohol and/or alcohol-based substances or solvents.

CARBON FIBRE PARTS

To eliminate small scratches and marks on the carbon, contact an Alfa Romeo Dealership Authorized Point. An improperly performed operation may irreparably damage the carbon.



WARNING

214) *ever use flammable products, such as petrol ether or rectified petrol to clean the inside of the car. The electrostatic charges which are generated by rubbing during the cleaning operation may cause a fire.*

215) *Do not keep aerosol cans in the car: they might explode. Aerosol cans must not be exposed to temperatures above 50°C. Temperatures may greatly exceed this value inside a car exposed to direct sunlight.*

216) *There must be no obstacles on the floor under the pedals. Make sure that mat are always flat and do not interfere with the pedals.*

217) *Do not use aggressive organic substance such as: petrol, kerosene, oil, acetone or solvents.*



IMPORTANT

99) *Never use alcohol, petrols and derivatives to clean the dashboard and instrument panel lens.*

100) *Do not use "hard" synthetic brushes as they could damage the fabric irreparably. Do not perform partial, localized interventions that could cause "aesthetic" differences between the treated and untreated areas. Do not use alcohol or acetone-based solvents.*



Everything you may find useful for understanding how your vehicle is made and works is contained in this section and illustrated with data, tables and graphics. For the enthusiasts and the technician, but also just for those who want to know every detail of their car.

TECHNICAL SPECIFICATIONS

IDENTIFICATION DATA	242
ENGINE	243
TRANSMISSION	245
RIMS AND WHEELS	246
DIMENSIONS	251
WEIGHTS AND LOADS	253
REFILLING	255
FLUIDS AND LUBRICANTS	259
PERFORMANCE	263
FUEL CONSUMPTION AND CO ₂ EMISSIONS	264
PRESCRIPTIONS FOR HANDLING THE CAR AT THE END OF ITS LIFE	265

IDENTIFICATION DATA

VEHICLE IDENTIFICATION NUMBER

The Vehicle Identification Number (VIN) is stamped on a plate on the front left corner of the dashboard cover fig. 273, which can be seen from outside the vehicle, through the windscreen.



273

10016V0001EM

This number is also printed on the chassis at the front right shock absorber and can be seen by opening the bonnet fig. 274.

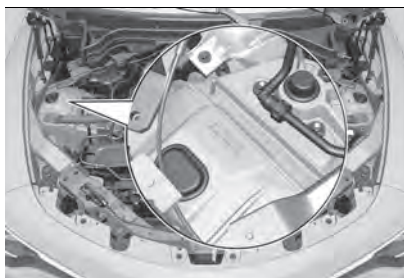

274

10016V0002EM

VEHICLE IDENTIFICATION NUMBER (VIN) PLATE

The plate is located on the left side front door pillar fig. 275 and shows the data about:

- 1: correct value of smoke coefficient (for Diesel engines);
- 2: name of the manufacturer, vehicle type-approval number, vehicle identification number, max. permitted weights;
- 3: engine identification, type variant version, spare part number, colour code, additional information.



275

10016V0003EM

ENGINE

	2.9 V6 510 HP	2.9 V6 520 HP	2.0 T4 MAir
Cycle	Otto	Otto	Otto
Number and position of cylinders	6 a V	6 a V	4 in line
Piston bore and stroke (mm)	86.5 x 82	86.5 x 82	84 x 90
Total displacement (cm ³)	2891	2891	1995
Compression ratio	9.3:1	9.3:1	10 ± 0.35
Maximum power (ECE) (kW)	375	382	206
Maximum power (ECE) (HP)	510	520	280
Corresponding engine speed (rpm)	6500	6500	5250
Maximum torque (ECE) (Nm)	600	600	400
Maximum torque (ECE) (kgm)	61	61	40.8
Corresponding engine speed (rpm)	2500	2500	2250
Spark plugs	NGK LKAR8APTJDS	NGK LKAR8APTJDS	NGK ILZKR7G
Fuel	Unleaded petrol with at least 95 R.O.N. (EN228 specifications) (*)	Unleaded petrol with at least 95 R.O.N. (EN228 specifications) (*)	Unleaded petrol with at least 95 R.O.N. (EN228 specifications)

(*) In order to comply with all emission limits while simultaneously guaranteeing minimal consumption and maximum performance, use premium unleaded petrol with octane rating (R.O.N.) 98 or more.



ABC

2.2 JTD	160 HP	210 HP
Cycle	Diesel	Diesel
Number and position of cylinders	4 in line	4 in line
Piston bore and stroke (mm)	83 / 99	83 / 99
Total displacement (cm ³)	2143	2143
Compression ratio	15.5 ± 0.4	15.5 ± 0.4
Maximum power (ECE) (kW)	118	154
Maximum power (ECE) (HP)	160	210
Corresponding engine speed (rpm)	3750	3500
Maximum torque (ECE) (Nm)	450	470
Maximum torque (ECE) (kgm)	45.9	47.9
Corresponding engine speed (rpm)	1750	1750
Fuel	Diesel for motor vehicles (EN590 Specification)	

TRANSMISSION

Version	Transmission	Traction
2.9 V6	Eight forward gears plus reverse with synchronisers for forward gears and reverse	All-wheel drive
2.0 T4 MAir	Eight forward gears plus reverse with synchronisers for forward gears and reverse	Rear or All-wheel drive
2.2 JTD	Eight forward gears plus reverse with synchronisers for forward gears and reverse	Rear or All-wheel drive



ABC

RIMS AND WHEELS

Alloy rims. Tubeless radial carcass tires. All approved tires are listed in the Registration Certificate.

WARNING If there are any discrepancies between the Owner Handbook and the Registration Document, take the information from the latter. For safe driving, the car must be fitted with tyres of the same make and type on all wheels.

WARNING Do not use air chambers with tubeless tyres.

WARNING Using tyres of a different size, type, brand or design at the front and rear may adversely affect car driveability. We recommend using tyres approved by the manufacturer. The manufacturer cannot determine if unapproved tyres are suitable for use and therefore cannot guarantee vehicle safety in those conditions.

CORRECT READING OF THE TYRE

Example fig. 276: 215/65 R16 98H

215 Nominal width (S, distance in mm between sides)

65 Height/width ratio (H/S), expressed as a percentage

R Radial tyre

16 Rim diameter in inches (\emptyset)

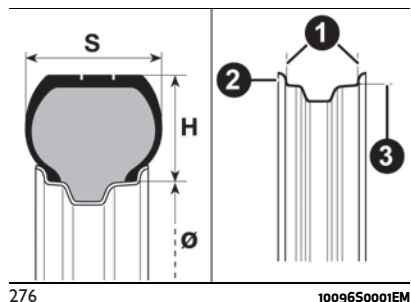

98 Load rating (capacity)

H Maximum speed rating

Maximum speed index

Q up to 160 km/h

R up to 170 km/h

S up to 180 km/h

T up to 190 km/h

U up to 200 km/h

H up to 210 km/h

V up to 240 km/h

W up to 270 km/h

Y up to 300 km/h

Maximum speed index for snow tyres

QM+S up to 160 km/h

TM+S up to 190 km/h

HM+S up to 210 km/h

Load rating (capacity)

60= 250 kg **80**= 450 kg

61= 257 kg **81**= 462 kg

62= 265 kg **82**= 475 kg

63= 272 kg **83**= 487 kg

64= 280 kg **84**= 500 kg

65= 290 kg **85**= 515 kg

66= 300 kg **86**= 530 kg

67= 307 kg **87**= 545 kg

68= 315 kg **88**= 560 kg

69= 325 kg **89**= 580 kg

70= 335 kg **90**= 600 kg

71= 345 kg **91**= 615 kg

72= 355 kg **92**= 630 kg

73= 365 kg **93**= 650 kg

74= 375 kg **94**= 670 kg

Load rating (capacity)

75= 387 kg **95**= 690 kg

76= 400 kg **96**= 710 kg

77= 412 kg **97**= 730 kg

78= 425 kg **98**= 750 kg

79= 437 kg

CORRECT READING OF THE RIM CODE

Example fig. 276: 7J x 17 H2 ET 40

7 width of the rim in inches (1).

J rim drop centre outline (side projection where the tyre bead rests) (2).

17 fitting diameter, expressed in inches (corresponds to the diameter of the tyre that should be fitted) (3 = Ø).

H2 shape and number of humps (circumference measurement which keeps the bead of tubeless tyres in position on the rim).

ET 40: wheel compensation (distance between the disc/rim supporting plane and the wheel rim centre line).

SNOW CHAINS



Rear-Wheel Drive and All-wheel drive versions

It is possible to fit 13 mm chains on all the tyres except for R20.

QV version

It is possible to put chains on the rear 285/40 R20 tyre (winter tyre size).

Avoid using traditional chains as they can damage the braking system if not installed correctly, thereby compromising the car's safety.

We strongly advise using zero-clearance chains and to use equipment proposed by the Dedicated Alfa Romeo Dealership.

Warnings

The use of snow chains should be in compliance with local regulations of each country. In certain countries, tyres marked with code M+S (Mud and Snow) are considered as winter equipment; therefore their use is equivalent to that of the snow chains.

The snow chains may be applied only to the rear wheel tyres.

Check the tension of the snow chains after the first few feet/meters have been driven.

WARNING Using snow chains with tyres with non-original dimensions may damage the car.

WARNING Using different size or type (M+S, snow, etc.) tyres between front and rear axle may adversely affect car driveability, with the risk of losing control of the car and resulting accidents.



IMPORTANT

101) *Keep your speed down when snow chains are fitted; do not exceed 50 km/h. Avoid potholes, do not drive over steps or pavements and do not drive long distances over roads without snow, to avoid damaging both your car and the road surface.*



ABC

RIMS AND TYRES PROVIDED

Version	Rims	Tyres
2.9 V6	20 x 9J ET29 (FRONT) 21 x 9J ET29 (FRONT)	255/45 R20 101Y (FRONT) 255/40 R21 102Y XL (FRONT)
	20 x 10J ET34 (REAR) 21 x 10J ET34 (REAR)	285/40 R20 104Y (REAR) 285/35 R21 105Y XL (REAR)
2.0 T4 MAir	18 x 8J	235/60 R18 107W XL
	19 x 8J	235/55 R19 101Y
2.2 JTD	20 x 8.5J	255/45 R20 105W XL
	21 x 8.5J	255/40 R21 102W XL
Space-saver wheel (where provided)	-	195/75 18 106P

NOTE In partnership with Pirelli, Alfa Romeo has developed a range of tyres specially for the Alfa Romeo Stelvio. They can be identified by the "AR" mark. The "AR" tyres ensure the best vehicle performance and safety. Alfa Romeo cannot guarantee that non-approved tyres are suitable, and they may cause vehicle malfunctions.

2.9 V6 engine: winter tyres are available in the following sizes: 255/45 R20 101W (M+S) and 285/40 R20 104W (M+S).

2.0 T4 MAir and 2.2 JTD engines: winter tyres are available in the following sizes: 235/60 R18 103V, 235/55 R19 101V and 255/45 R20 101W.

Always check the registration certificate for the tyres that can be installed (size, load index, speed symbol).

COLD TYRE INFLATION PRESSURE

When the tyres are warm, the inflation pressure should be + 4.35 psi (+0.3 bar) in relation to the recommended figure. However, recheck the correct value when the tyre is cold. If it is necessary to raise the vehicle, refer to the "Raising the vehicle" chapter in the "In an emergency" section.

The pressures given below apply to all tyre types: summer and winter.

2.9 V6 Engine

Tyres	Unladen/medium load [psi / bar]		Full load [psi / bar]	
	Front	Rear	Front	Rear
225/45 R20 101Y	33.3 / 2.3	-	39.2 / 2.7	-
255/40 R21 102Y XL	39.2 / 2.7	-	39.2 / 2.7	-
285/40 R20 104Y	-	36.3 / 2.5	-	42.2 / 2.9
285/35 R21 105Y XL	-	42.2 / 2.9	-	42.2 / 2.9

2.0 T4 MAir and 2.2 JTD engines

Tyres	Unladen/medium load [psi / bar]		Full load [psi / bar]	
	Front	Rear	Front	Rear
235/60 R18	30.5 / 2.1	33.3 / 2.3	33.3 / 2.3	37.7 / 2.6
235/55 R19	30.5 / 2.1	33.3 / 2.3	33.3 / 2.3	37.7 / 2.6
255/45 R20	33.3 / 2.3	36.3 / 2.5	34.8 / 2.4	39.2 / 2.7
255/40 R21	33.3 / 2.3	36.3 / 2.5	34.8 / 2.4	39.2 / 2.7
195/75 18 (Space-saver spare wheel)		43.5 / 3.0		

If winter tyres are fitted, always use the same inflation pressures as for the tyres originally installed (table above).



**WARNING**

218) *If winter tyres with a lower speed rating than that indicated in the Registration Document are used, do not exceed the maximum speed corresponding to the speed rating of the tyres used.*

DIMENSIONS

Dimensions are expressed in inches/mm and refer to the car equipped with its original tyres. Height is measured with car unladen.

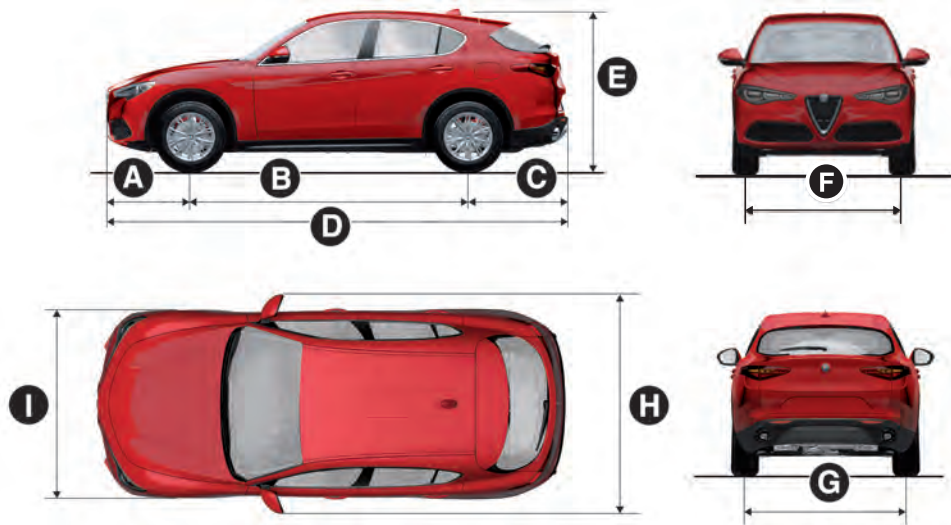

277

9490102

A	B	C	D	E	F	G	H	I
33.9/861	110.94/2818	39.68/1008	184.5/4687	64.2/1632 66.6/1693	63.5/1613 63.8/1621 (*) (**)	65.2/1657 64.7/1644 (*) 65.1/1654 (**)	85.1/2163	75/1903

(*) Versions with 20" tyres / (**) Versions with 21" tyres

Small variations with respect to the reported values are possible depending on the dimensions of the rims.



ABC

QV VERSION

Dimensions are expressed in inches/mm and refer to the car equipped with its original tyres. Height is measured with car unladen.

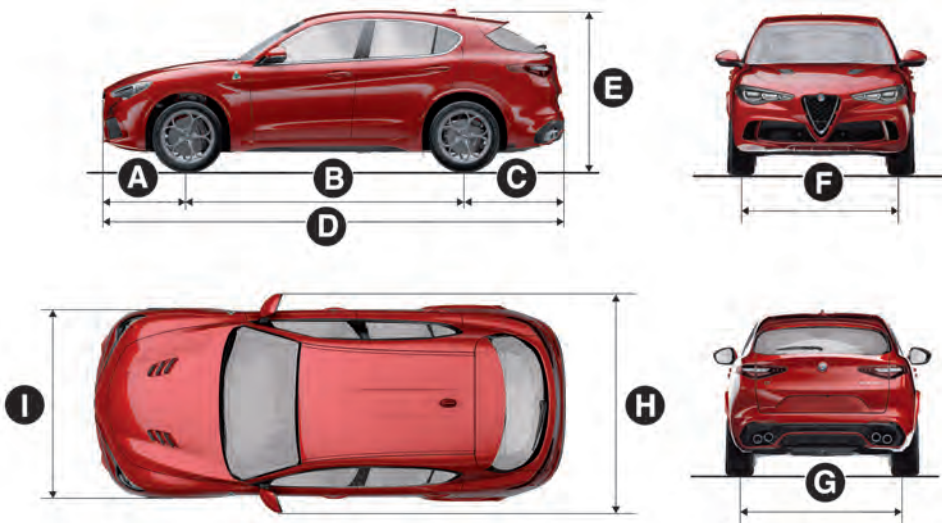

278

9490103

A	B	C	D	E	F	G	H	I
34 / 866	110.9 / 2818	40.1 / 1.018	185.2 / 4701	66.2 / 1680 - 66.5 / 1689	63.8 / 1623	66.2 / 1681 (*) 65.2 / 1658 (**)	85.1 / 2163	76.9 / 1955

(*) Versions with 20" tyres / (**) Versions with 21" tyres

LUGGAGE COMPARTMENT VOLUME

Capacity (V.D.A. standards)

Non-folding rear seats (unladen car): 525 litres

WEIGHTS AND LOADS



To identify the weights and loads for your car, refer to the plate shown in fig. 279 and described in the "Vehicle identification number (VIN) plate" chapter or refer to the car registration certificate showing the type-approved weights (for markets, where provided).

D: Maximum authorised weight of car fully laden (GVW).

E: Maximum authorised weight of fully laden car (GVW) plus trailer. If there is no value in the field or if there is a dash, it means that the car cannot tow.

F: Maximum permitted weight on first front axle.

G: Maximum permitted weight on second rear axle.

	ALFA ROMEO S.p.A.	MOTORE-ENGINE	COCCIA COLORE
	120 / 2016 / XXXX XXXX	13200-3000	1234
	ZARXXXXXXXXXXXXXXXXXX	VERSIONE-VERSION	123456789D
1.	D Kg	N° PER RICAMBI	
	E Kg	N° FOR SPARES	
	F Kg	XXXXXXXX	
2.	G Kg	MADE IN ITALY	

279

1010650090EM

To calculate the towable weight with a braked trailer, take the difference between values (E) e (D) shown on the plate.

E.g.: E= 8750 lb (3950 kg) - D= 5170 lb (2350 kg)

Braked trailer = 3527 lb (1600 kg)

WARNING Do not exceed the indicated trailer and towable weights.

WARNING Respect the vehicle towing capacities.

WARNING Never exceed the maximum permitted load indicated on the plate (E).



ABC

TOWABLE WEIGHTS (lb / kg)

	2.9 V6	2.0 T4 MAir	2.2 JTD	
			RWD versions	AWD versions
GVW	5421 / 2460	5170 / 2350	5126 / 2330	5302 / 2410
Towable loads				
A	-	3527 (1600) / 5070 (2300) (*)	3527 / 1600	5070 / 2300
B	-	1653 / 750	1653 / 750	1653 / 750
C	-	141 (64) / 209 (95) (*)	141 / 64	209 / 95
D	165 / 75	165 / 75	165 / 75	165 / 75

A = TOWABLE WEIGHT

B = UNBRAKED TRAILER

C = LOAD ON TOW HOOK

D = LOAD ON ROOF

(*) With the "tow hook" optional original equipment. For the maximum towable load, always refer to the Registration Document.

REFILLING

	2.9 V6	2.0 T4 MAir	Prescribed fuels and original lubricants
Fuel tank (UK gal / litres)	14 / 64	14 / 64	Unleaded petrol (EN228 specifications)
including a reserve of (UK gal / litres)	2.1 / 9.6	2.1 / 9.6	
Main cooling system (UK gal / litres)	2.46 / 11.2	1.93 (8.8) (*) / 2.02 (9.25) (****)	50% mixture of distilled water and PARAFLU UP (**)
Secondary cooling system (UK gal / litres)	1.25 / 5.75	0.95 (4.3) (*) / 1.15 (5.25) (****)	
Engine oil filter (UK gal / litres)	-	0.08 / 0.4	SELENIA QUADRIFOGLIO (2.9 V6 engine) / SELENIA DIGITEK P.E. (2.0 T4 MAir engine)
Engine oil sump (UK gal / litres)	-	1.01 / 4.6	
Engine sump and filter (UK gal / litres)	1.42 / 6.5	-	
Hydraulic brake circuit (UK gal / litres)	0.2 / 0.9	0.2 / 0.9	TUTELA BRAKE FLUID TOP EVO
Windscreen washer tank (UK gal / litres)	0.92 / 4.2	0.9 / 4.1	PETRONAS DURANCE SC 35
Automatic transmission AWD (UK gal / litres)	2.01 / 9.11	2.05 / 9.3	TUTELA TRANSMISSION AS 8
Automatic transmission RWD (UK gal / litres)	-	2.07 / 9.4	
RDU 230-LSD differential (UK gal / litres)	0.25 / 1.1	0.2 / 0.9	TUTELA TRANSMISSION LS AXLE FLUID



ABC

	2.9 V6	2.0 T4 MAir	Prescribed fuels and original lubricants
RDU 210-eLSD differential (where provided) (UK gal / litres)	-	0.24 / 1.1	TUTELA TRANSMISSION LS AXLE FLUID
AWD System FAD transfer case (UK gal / litres)	0.09 / 0.45	0.11 / 0.5	TUTELA TRANSMISSION HYPOIDE GEAR OIL
AWD System TRANSFER CASE (UK gal / litres)	0.15 / 0.7	0.15 / 0.7	TUTELA TRANSMISSION TRANSFER CASE

(*) Without “tow hook” optional original equipment

(**) When the vehicle is used in particularly harsh weather conditions, we recommend using a 60% mixture of PARAFU UP and 40% demineralised water.

(***) With the “tow hook” optional original equipment.



102) 103)

	2.2 JTD	Prescribed fuels and original lubricants
Fuel tank (UK gal / litres)	58 / 64 (*)	Diesel for motor vehicles (EN590 Specification)
including a reserve of (UK gal / litres)	1.98 (9.0) / 2.2 (10) (**)	
AdBlue® tank (where provided) capacity approximately (UK gal / litres)	3.5 / 16.1	AdBlue® (DIN 70 070 and ISO 22241-1 specifications)
Main cooling system (UK gal / litres)	1.71 (7.8) / 1.75 (8.0) (***)	50% mixture of distilled water and PARAFLO UP (*)
Secondary cooling system (UK gal / litres)	1.03 / 4.7 (***)	
Engine oil filter (UK gal / litres)	0.11 / 0.5	SELENIA W.R. FORWARD 0W-20
Engine oil sump (UK gal / litres)	0.85 / 3.9	
Hydraulic brake circuit (UK gal / litres)	0.02 / 0.9	TUTELA BRAKE FLUID TOP EVO
Windscreen washer tank (UK gal / litres)	0.92 / 4.2	PETRONAS DURANCE SC 35
Automatic transmission (UK gal / litres)	2.0 / 9.1	TUTELA TRANSMISSION AS8
RDU 230-LSD differential (UK gal / litres)	0.02 / 0.9	TUTELA TRANSMISSION LS AXLE FLUID
RDU 210/215-LSD differential (UK gal / litres)	0.24 / 1.1	
AWD System FAD transfer case (UK gal / litres)	0.11 / 0.5	TUTELA TRANSMISSION HYPOIDE GEAR OIL



ABC

	2.2 JTD	Prescribed fuels and original lubricants
AWD System TRANSFER CASE (UK gal / litres)	0.15 / 0.7	TUTELA TRANSMISSION TRANSFER CASE

(*) For markets where provided.

(**) Versions with 14 UK gal / 64 litre fuel tank.

(***) 210 HP AWD version

(****) When the vehicle is used in particularly harsh weather conditions, we recommend using a 60% mixture of PARAFLU UP and 40% demineralised water.



IMPORTANT

102) Only use AdBlue® (UREA) compliant with DIN 70 070 and ISO 22241-1. Other fluids may cause damage to the system: also exhaust emissions would no longer comply with the law.

103) The distribution companies are responsible for the compliance of their product. Observe the precautions of storage and servicing, in order to preserve the initial qualities. The manufacturer will not recognise any guarantee in case of malfunctions and damage caused to the car due to the use of AdBlue® (UREA) not in accordance with regulations.

FLUIDS AND LUBRICANTS

Your car is equipped with an engine oil that has been thoroughly developed and tested in order to meet the requirements of the Service Schedule. Constant use of the prescribed lubricants guarantees the fuel consumption and emission specifications. Lubricant quality is crucial for engine operation and duration.



PRODUCT SPECIFICATIONS

ENGINE LUBRICATION

Use	Features	Specification	Original liquids and lubricants	Replacement frequency
2.9 V6	SAE 5W-40 ACEA C3	9.55535-GH2	SELENIA QUADRIFOGLIO Contractual Technical Reference N°F022.B18	According to Service Schedule
2.0 T4 MAir	SAE 0W-30 ACEA C2	9.55535-GS1	SELENIA DIGITEK P.E. Contractual Technical Reference N°F020.B12	According to Service Schedule
2.2 JTD	SAE 0W-20 ACEA C5	9.55535-DSX	SELENIAW.R.FORWARD 0W-20 Contractual Technical Reference N°F013.K15	According to Service Schedule

If lubricants conforming to the specific request are not available, products that meet the indicated specifications can be used to top up; in this case optimal performance of the engine is not guaranteed.



ABC

Use	Features	Specification	Original liquids and lubricants	Applications
Lubricants and greases for drive transmission	ATF Synthetic lubricant	9.55550-AV5	TUTELA TRANSMISSION AS 8 Contractual Technical Reference N°F139.I11	Automatic transmission
	SAE 75W-85 synthetic lubricant	9.55550-DA9	TUTELA TRANSMISSION LS AXLE FLUID Contractual Technical Reference N°F059.N15	Differential RDU 230-LSD and RDU 210/215-LSD
	SAE 75W-80 APL GL-5 synthetic lubricant	9.55550-DA10	TUTELA TRANSMISSION HYPOIDE GEAR OIL Contractual Technical Reference n° F060.N15	AWD System FAD Transfer case
	SAE 75W synthetic lubricant	9.55550-DA11	TUTELA TRANSMISSION TRANSFER CASE Contractual Technical Reference N°F061.N15	AWD System TRANSFER CASE
	NLGI 0-1 grease for constant velocity joints with low friction coefficient	9.55580-GRAS II	TUTELA STAR 700 Contractual Technical Reference N°F701.C07	Differential side constant velocity joints
	NLGI 1-2 molybdenum disulphide grease for high temperatures	9.55580-GRAS II	TUTELA ALL STAR Contractual Technical Reference N°F702.G07	Wheel side constant velocity joints

Use	Features	Specification	Original liquids and lubricants	Applications
Brake fluid	Synthetic fluid for brake and clutch systems. Exceeds specifications: FMVSS n° 116 DOT 4, ISO 4925 Class 6, SAE J1704.	9.55597 or MS.90039	TUTELA BRAKE FLUID TOP EVO Contractual Technical Reference N°F002.L18	Hydraulic brakes and clutch controls
Protective agent for radiators	Protective with antifreeze, ethylene glycol based organic formula, free from amine and 2-EH (2-ethyl hexanoic acid), containing corrosion inhibitors and anti-foam additives. CUNA NC 956-16, ASTM D 3306	9.55523 or MS.90032	PARAFLU UP Contractual Technical Reference N°F101.M01	Use rate 50% Not mixable with different formulation products (*)
Windscreen washer fluid	CUNA NC 956-11	9.55522	PETRONAS DURANCE SC 35 Contractual Technical Reference N° F001.D16	To be used diluted or undiluted in windscreen washer/wiper systems
AdBlue® additive for diesel emissions	Water-AdBlue® solution	DIN 70 070 and ISO 22241-1	AdBlue®	To be used for filling the AdBlue® tank on versions equipped with Selective Catalytic Reduction (SCR) system (2.2 JTD engine)
Diesel fuel additive	Antifreeze additive for diesel fuel, with protective action for diesel engines	-	PETRONAS DURANCE DIESEL ART Contractual Technical Reference N°F601.C06	To be mixed with diesel (25 cc per 10 litres)



ABC

Use	Features	Specification	Original liquids and lubricants	Applications
Automatic climate control system (HVAC)	R1234yf or R134a (depending on market)	-	-	-

(*) When the vehicle is used in particularly harsh weather conditions, we recommend using a 60% mixture of PARAFU UP and 40% demineralised water.

AdBlue® is a registered trademark of Verband der Automobilindustrie e.V. (VDA)



IMPORTANT

104) The use of products with specifications other than those indicated above could cause damage to the engine not covered by the warranty.

PERFORMANCE

Top performance after the initial period of vehicle usage.

Versions	Maximum speed (mph / km/h)	Acceleration from 0-100 km/h (sec)
2.9 V6 510 HP	175 / 283	3.8
2.9 V6 520 HP	177 / 285	3.8
2.0 T4 MAir AWD	143 / 230	5.7
2.2 JTD 160 HP RWD	124 / 200	8.8
2.2 JTD 210 HP AWD	134 / 215	6.6



ABC

FUEL CONSUMPTION AND CO₂ EMISSIONS

The fuel consumption and CO₂ emission figures declared by the manufacturer are determined on the basis of the type-approval tests laid down by the applicable standards in the country where the vehicle is registered.

The type of route, traffic conditions, weather conditions, driving style, general condition of the car, trim level/equipment/accessories, use of the climate control system, car load, presence of roof racks and other situations that adversely affect the aerodynamics or wind resistance lead to different fuel consumption values than those measured.

The fuel consumption will only become more regular after driving the first 3000 km.

To find the specific fuel consumption and CO₂ emission figures for this car, please refer to the data in the Certificate of Conformity, and the related documentation that accompanies the vehicle.

PRESCRIPTIONS FOR HANDLING THE CAR AT THE END OF ITS LIFE

(where provided)

For years, Alfa Romeo S.p.A. has pursued a global commitment to protect and respect the environment by continually improving its production processes and developing increasingly "eco-compatible" products. To grant customers the best possible service in terms of respecting environmental laws and in response to European Directive 2000/53/EC governing vehicles at the end of their life, Alfa Romeo S.p.A. is offering its customers the chance to hand over their car at the end of its life without incurring any additional costs. The European Directive sets out that when the vehicle is handed over the last keeper or owner should not incur any expenses as a result of it having a zero or negative market value.

To hand your car over at the end of its life without extra cost, contact one of our dealerships if you are purchasing another car or an Alfa Romeo S.p.A.-authorised collection and scrapping centre. These centres have been carefully chosen to offer high quality service for the collection, treatment and recycling of vehicles at their end of life, respecting the surrounding environment.

You can find further information on these collection and scrapping centres either from an Alfa Romeo S.p.A. dealership or by calling the number in the Warranty Booklet or by consulting the Alfa Romeo S.p.A. website.



ABC



MULTIMEDIA

TIPS INFORMATION AND GENERAL INFORMATION	268
CONTROLS	270
CONTROLS ON THE STEERING WHEEL	273
"TOUCHSCREEN" FUNCTION	274
WIDGETS	275
RADIO (TUNER) MODE	278
MEDIA MODE	278
Bluetooth® SOURCE	279
USB/iPod/AUX SUPPORT	279
CLIMATE CONTROL SYSTEM	280
PHONE MODE	281
NAVIGATION MODE	282
Tom Tom® ONLINE SERVICES	284
SETTINGS	286
PERFORMANCE	288
CAR INFORMATION	288
DRIVER ASSISTANCE	288
Apple CarPlay and Android Auto	290
VOICE COMMANDS	292
CONNECTED SERVICES - ALFA CONNECT SERVICES	293
WIRELESS CHARGING SYSTEM- WCPM (Wireless Charge Pad Module)	298
OFFICIAL TYPE APPROVALS	299

This section describes the main features of the Connect system that can be fitted on the car.

TIPS INFORMATION AND GENERAL INFORMATION

ROAD SAFETY



219) 220)

Learn how to use the varied system functions before starting to drive.

Read the instructions for the system carefully before starting to drive.

WARNING Look at the screen only and when it is necessary and safe. If you need to look at the screen for a long time, pull over to a safe place so as not to be distracted while driving. Immediately stop using the system in the event of a fault. Otherwise the system might be damaged. Contact an Alfa Romeo Dealership as soon as possible to have the system repaired.

RECEPTION CONDITIONS

(where provided)

Reception conditions change constantly while driving. Reception may be interfered with by the presence of mountains, buildings or bridges, especially when you are far away from the broadcaster.

WARNING The volume may be adjusted when receiving traffic information and news.

NOTE The DAB frequency can be used in countries where digital transmission technology is available. The device will

tuned to any frequency if the DAB button is pressed in a country where the service is not provided.

CARE AND MAINTENANCE



105) 106)

Observe the following precautions to ensure the system is fully operational:

- avoid hitting the display lens with pointed or hard objects that could damage its surface.
- clean with a damp cloth (microfibre if possible). If necessary, you can use a delicate mild soap and water solution, then dry with a soft, dry cloth. Do not apply pressure to the display lens while cleaning;
- do not use alcohol, petrol and derived products them to clean the display lens and make sure that the Connect system is switched off during cleaning;
- prevent any liquid from entering the system: this could damage it beyond repair.

CONNECT SYSTEM USE

To interact with the Connect system you can use the controls on the central tunnel, on the steering wheel, using the touchscreen function or the voice controls.

ANTI-THEFT PROTECTION

The system is equipped with an anti-theft protection system based on

the exchange of information with the electronic control unit (Body Computer) on the vehicle.

This guarantees maximum security and prevents the system from being used on other cars in the event of theft. If necessary contact an Alfa Romeo Dealership.

IMPORTANT NOTES

Look at the screen only and when it is necessary and safe. If you need to look at the screen for a long time, pull over to a safe place so as not to be distracted while driving.

Immediately stop using the system in the event of a fault.

Otherwise the system might be damaged. Contact an Alfa Romeo Dealership as soon as possible to have the system repaired.



WARNING

219) Follow the safety rules below: otherwise serious injuries may occur to the occupants or the system may be damaged.

220) If the volume is too loud this can be dangerous. Adjust the volume so that you can still hear background noises (e.g. horns, ambulances, police vehicles, etc.).



IMPORTANT

105) Only clean the front panel and the display with a soft, clean, dry, anti-static cloth. Cleaning and polishing products may damage the surface. Do not use alcohol or similar products to clean the control panel or the display.

106) Do not use the display as a base for supports with suction pads or adhesives for external navigators or smartphones or similar devices.



CONTROLS

CONTROLS ON TUNNEL

On the central tunnel, fig. 280, there are commands to interact with the Connect system.

SETTINGS button (1)

Pressing the "Settings" button  while within the modes ("RADIO", "MEDIA", "PHONE", "NAVIGATION") will open the "Settings" Display the mode in question.

Press the button it again will return to the previously selected mode.

MENU button (2)

Press the button  to access the Main Menu.

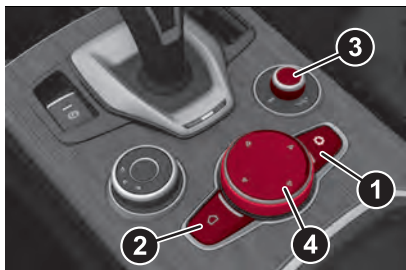

280

1212650300EM

DESCRIPTION OF CONTROLS TABLES

ON/OFF and VOLUME control (3)

Action	Function
LONG PRESS	Switching the Connect system on/off
SHORT PRESS	Radio Mode: Activate/deactivate the Mute function Media Mode: Activate/deactivate play/pause Phone Mode: Activate/deactivate the microphone during a phone call
ROTATION	Turn clockwise to increase the volume/turn anticlockwise to decrease the volume
MOVE TO THE SIDE	Radio mode: on the right to select next/left radio station/on the left to select previous station (radio station search can be done by "Frequency"/"Name"/"Favourites") Media mode: short press on the right: select next track/short press on left select previous track Long press on right ("Media" mode): go to next track/long press on left, go to previous track



ABC

Rotary Pad (4)

Action	Function
ROTATION	In the Menus: confirms selection In Navigation mode (where provided): zooms the maps (where provided)
SHORT PRESS	In the Menus: confirms selection
LONG PRESS	Radio mode: store radio station on the radio station bar/store a favourite on the preset bar
BRIEF TOUCH RIGHTWARDS (*)	In the Menus: goes to the submenu of the selected function In Navigation mode (where provided), in "Browse Map": moves rightwards on the Navigation map to move inside the navigation map (where provided)
BRIEF TOUCH LEFTWARDS (*)	In the Menus: goes back to the previous menu ("Esc" function) In Navigation mode (where provided), in "Browse Map": moves leftwards on the map Navigation to move inside the navigation map (where provided)
BRIEF TOUCH UPWARDS (*)	In the Menus: closes the preset bar In Navigation mode (where provided), in "Browse Map": moves upwards on the map to move inside the navigation map (where provided)
BRIEF TOUCH DOWNWARDS (*)	Activating radio presettings/Saving "Contacts" and "Destinations" In the Menus: opens the preset bar In Navigation mode (where provided), in "Browse Map": moves downwards on the map Navigation to move inside the navigation map (where provided)

(*) The Rotary Pad must be tilted in the indicated direction ("tilt" function)

CONTROLS ON THE STEERING WHEEL

DESCRIPTION

The controls fig. 281 for the main system functions are present on the steering wheel to make control easier. The activation of the function selected is controlled, in some cases, by the length of the press (short or long press) as described below.

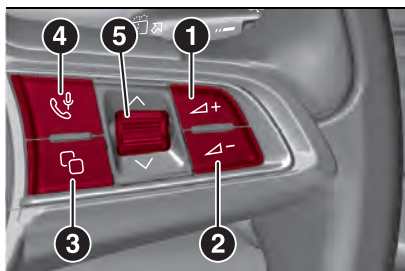

281

9550179

(1) (2) Volume controls (↔+ / ↔-)

- ❑ **Short press:** turn the volume up/down by one step
- ❑ **Long press:** turn the volume up/down by one step

(3) Screen selection / main widget / default

- ❑ **Short press:** switch between the main (or default) screen display (in the central area of the instrument panel display), or the widget display (inside

the tachometer on the instrument panel display)

(4) Telephone / Voice commands

Short press (Phone Mode)

- ❑ Answer / end call

Short press (Voice commands)

- ❑ **With voice session not active:** activation of Connect system voice controls if no phone mode is active
- ❑ **With voice session active:** immediately close voice session in progress

Long press (Voice commands)

- ❑ **With voice session active:** interrupt voice session in progress (a new voice command can be imparted)
 - ❑ **With the voice session not active and an external audio device connected (e.g. Apple CarPlay / Android Auto):** activate a voice session on the connected device
- NOTE Connection to the phone disables voice command.

NOTE If Apple CarPlay and Android Auto apps are present, Siri voice assistant (for Apple CarPlay) or Google Assistant (for Android Auto) will be activated. In this case you can use "Natural language" voice controls and not just the specific ones preset for the Alfa Connect system. The voice assistants of Siri (for Apple CarPlay) or Google Assistant (for Android Auto) will only be activated by

holding the button  pressed on the right side of the steering wheel.

(5) Selection of items displayed on screens/widgets (^ / v)

- ❑ **Upward rotation:** select next radio station (Radio mode) / select next track (Media mode).
- ❑ **Downward rotation:** select previous radio station (Radio mode) / select previous track (Media mode).
- ❑ **Short press:** confirm the actions suggested by the messages on the instrument panel display.
- ❑ **Long press:** reset the Trip Computer readings on the instrument panel display.









ABC

"TOUCHSCREEN" FUNCTION

The Connect system is also equipped with a touchscreen function: in addition to the selection of items using the controls on the central tunnel and on the steering wheel, it is possible to interact with the various functions/modes by pressing on the icons shown the display.

ACTIONS THAT CAN BE PERFORMED USING THE TOUCHSCREEN FUNCTION

Function	Action on the display
SCROLL UP	
SCROLL DOWN	
MOVE LEFTWARDS	
MOVE RIGHTWARDS	
SHORT PRESS	
LONG PRESS	

WIDGETS

WIDGET INTERACTION MODES

Widgets, displayed on the Connect system display, give access to the various operating modes of the system. To interact with the widgets on the Main Menu use the touchscreen function or the Rotary Pad located on the central tunnel.

One of the following operations can be performed:

□ **open the widget** by pressing on it (touchscreen) or by pressing the Rotary Pad;

□ **scroll the widgets** rightwards/leftwards using the touchscreen function or by turning the Rotary Pad rightwards/leftwards.

MOVING THE WIDGETS

You can move the widgets on the display using the touchscreen function or using the commands located on the central tunnel.

Using the touchscreen function

Select the desired widget or press the "Reorder" (⇄) button on the vertical status bar and then:

□  **Moving the widget:** hold the desired widget pressed for a few

seconds and then move it to the right or left of the display.

□  **Resizing the widget:** press the widget resize icon to be resized.

□  **View widget content:** select the desired widget and then scroll vertically. When reordering the widgets (viewing their thumbnails), it will not be possible to view their contents.

Using the controls located on the central tunnel

Proceed as follows:

□ press the  button on the central tunnel: a horizontal bar graph fig. 282 will appear on the upper part of the display;

□ turn the Rotary Pad to select the "Settings" item;

□ press the Rotary Pad to confirm the selection and then select one of the following items:

- "Widget reorder": to move the desired widget to the right or left of the display.
- "Widget resize": to change the size of the widget display to "1/3 view" or "2/3 view" of the display area.

- "Widget content": to view the content of the desired widget.

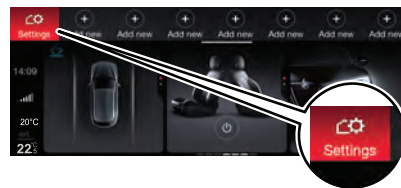

282



12126V0906EM

RESIZING WIDGETS

Some widgets can occupy 1/3 or 2/3 of the display area.

Using the touchscreen function

□ **"1/3" view** fig. 283: icons, menu name, main information, graphic buttons (up to 3) (where provided) appear on the display.

□ **"2/3" view** fig. 284: to activate the enlarged display of the widget, press the "enlarge" graphic button  (where provided) located on the top of the widget itself. To return from the "1/3" view, press the graphic button .



ABC



283

1212650909EM



284

1212650910EM

Using the controls located on the central tunnel

Activate the "Settings" menu and then select the item "Widget resize".

Only the resizable widgets will be activated (these will appear on the display with a different colour from those that cannot be resized and therefore cannot be selected).

To resize the widget and switch to "2/3" view, press the Rotary Pad.

Press the graphic button  to return to the normal view.

NOTE It is not possible to keep two widgets in "2/3 view" mode on the display at the same time.

VIEWING WIDGET CONTENTS

Using the touchscreen function

To change the widget view, select it and swipe vertically, either upwards or downwards.

Using the controls located on the central tunnel

Activate the "Settings" menu and then select the "Widget content" item: only the widgets with content will be active and selectable on the display.

Proceed as follows to view the contents of the widgets:

- turn the Rotary Pad to select the desired widget;
- press the Rotary Pad to confirm the selection;
- turn the Rotary Pad to display the contents of the widget;
- press the Rotary Pad to keep the display active and exit the widget.

REORDER THE WIDGETS

The widgets can be reordered on the Main Menu in two different ways:

- **"Explicit"**: by pressing the "Reorder"  graphic button located on the upper left of the display fig. 285
- **"Implicit"**: by holding the desired widget pressed for a few seconds.



285

1212650919EM

Using the touchscreen function

Explicit mode

In both modes, the size of the widgets will be reduced and displayed, up to a maximum of 5, on the display.

NOTE When reordering the widgets (viewing their thumbnails), it will not be possible to view their contents.

Proceed as follows:

- press the graphic button  located in the upper left part of the display: the first widget will be displayed;
- press and hold down the desired widget and drag it to the desired position;

□ release the widget: the new position of the widget will be stored by the Connect system.



286

1212650922EM

Implicit mode

Proceed as follows:

- hold the desired widget pressed: the widgets will be reduced and displayed, up to a maximum of 5, on the display. The selected widget will remain displayed and will be larger in size;
- press and hold down the desired widget and drag it to the desired position;
- release the widget: the new position of the widget will be stored by the Connect system.

To return to the Main Menu press the graphic buttons  or .

Using the controls located on the central tunnel

Activate the "Settings" menu and then select "Widget reorder": the first widget will be displayed automatically.

Proceed as follows to reorder the widgets:

- turn the Rotary Pad and select the desired widget: the widget will be highlighted on the display;
- press the Rotary Pad: a graphic arrow  will appear next to the widget, indicating the direction in which you can move the widget;
- turn the Rotary Pad to move the widget to the desired position;
- press the Rotary Pad to store the new widget location (the widget will continue to be highlighted on the display).

To go back to the Main Menu, turn the Rotary Pad to the left or press the button  on the central tunnel.

SHORTCUT MENU

Proceed as follows to activate the status bar display:

- *Using the touchscreen function:* touch the upper part of the display, fig. 287, and slide your finger down.
- *Using the controls on the central tunnel:* move Rotary Pad 1 fig. 288 downwards.

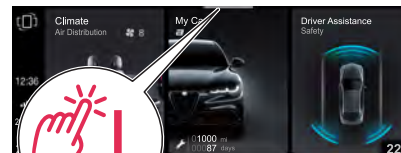

287

12126V2302EM



288

1212650765EM

The "shortcut" menu can be used to:

- access the "Settings" menu;
- quickly access the stored radio station "Favourites" or "Contacts" or navigation "Destinations";
- add graphic buttons to quickly access the desired function.



ABC

RADIO (TUNER) MODE

RADIO MODE SELECTION (TUNER)

"RADIO" mode can be activated by using the appropriate widget in the main menu of the Connect system.

NOTE Some "RADIO" mode functions can be activated in addition to using the Rotary Pad and/or the touchscreen function, also using voice controls: for more information, see the "AM/FM/DAB Radio voice commands" paragraph in the "Voice controls" chapter in this publication.

MAIN SCREEN RADIO MODE

The following information will be displayed after selecting the desired radio station on the display fig. 289.



289

1212650926EM

Sidebar fig. 289

The following graphic buttons are displayed on the sidebar:

☐ **SRC**: can be used to select the required frequency band;

- ☐ ★ to select the Favourites list;
- ☐ ☰ to view the list of available radio stations;
- ☐ 📶 to manually seek a radio station.

Central zone of the display fig. 289

The following information is displayed in the central area of the display:

- ☐ selected frequency band (e.g. FM);
- ☐ name of the current radio station;
- ☐ logo of the active frequency band;
- ☐ transmitted programme type;
- ☐ current radio station frequency;
- ☐ radio mode graphic buttons (select previous radio station, activate/deactivate mute function, select next radio station);
- ☐ list and name of stored radio stations.

AUDIO

(where provided)

Proceed as follows to open the "Audio" menu:

- ☐ press the "Settings" ⚙ button on the central tunnel;
- ☐ turn the Rotary Pad to select the "Audio Settings" item.

When the function is activated, the following parameters can be set:

- ☐ "Bass" (-9; 0; +9);
- ☐ "Treble" (-9; 0; +9);

- ☐ "Mid" (-9; 0; +9);
- ☐ "Balance/Fade";
- ☐ "Volume/Speed" (OFF; +5);
- ☐ "Surround Sound" (OFF/ON) (where provided);
- ☐ "AUX Volume Comp." (OFF; +20);
- ☐ "Restore Settings".

MEDIA MODE

NOTE Some "MEDIA" mode functions can be activated in addition to using the Rotary Pad and/or the touchscreen function, also using voice controls: for more information, see the "Media voice controls" paragraph in the "Voice controls" chapter in this publication.

AUDIO SOURCE SELECTION

When the MEDIA source is active, the following information is shown on the display fig. 290:

- ☐ **SRC**: activate the list of sources
- ☐ ⇄ to activate Shuffle/Playback Mode
- ☐ 📖 to activate Tracks Library
- ☐ ☰ to activate the Playlists

Press the graphic button to activate "MEDIA" mode **SRC**: the display shows the available sources: AM, FM, DAB, **Bluetooth**®, USB1, USB2.



290

12126S0937EM



Bluetooth® SOURCE

Bluetooth® ACTIVATION

This mode is activated by pairing a **Bluetooth®** device containing music tracks with the system.

PAIRING A Bluetooth® AUDIO DEVICE

Proceed as follows:

- ❑ activate the **Bluetooth®** function on the device;
- ❑ open the main menu by pressing button  and select "Settings";
- ❑ select "Infotainment";
- ❑ select "Phone" and then "Bluetooth Settings";
- ❑ select the **Bluetooth®** fig. 291 device;
- ❑ select "Add Device" 
- ❑ search for the Connect system on the **Bluetooth®** audio device (during the pairing stage a screen will appear on the display showing the progress of the operation);

- ❑ select the device to be paired;
- ❑ when requested by the audio device, enter the PIN code shown on the system display or confirm on the device the PIN displayed;
- ❑ if the pairing procedure is completed successfully, a dedicated screen will appear.

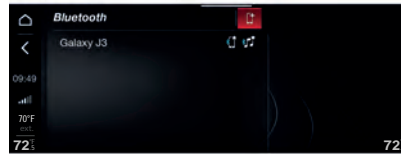

291

12126S0430EM

The **Bluetooth®** function can also be reached by pressing the "OPTIONS" button in the "PHONE" or "MEDIA functions", which can be selected on the main menu.

WARNING If the **Bluetooth®** connection between mobile phone and system is lost, consult the mobile phone handbook.

NOTE When modifying the name-device in the **Bluetooth®** settings of the phone (where provided), the Radio may change the track being played if the device is connected via USB after the **Bluetooth®** connection. After updating the phone

software, for proper operation, it is recommended to remove the phone from the list of devices linked to the Connect system, delete the previous system pairing also from the list of **Bluetooth®** devices on the phone and make a new pairing.

USB/iPod/AUX SUPPORT

USB/iPod MODE

To activate the USB/iPod mode insert the corresponding device (USB or iPod) in one of the USB ports located:

- ❑ under the dual zone automatic climate control panel, (1) fig. 292;
- ❑ inside the storage compartment under the front armrest, (2) fig. 293.

NOTE The Connect system may not support some USB keys: in this case, it may not automatically switch from "Radio" mode to "Media" mode. If the device used does not play, verify its compatibility by selecting "Media" mode: a dedicated message will appear on the Connect system display.

WARNING After using a USB recharging port, we recommend disconnecting the device (smartphone), always removing the cable from the charging port of the vehicle first, never from the device. Cables left flying or connected incorrectly could compromise correct



ABC

recharging and/or the USB socket condition.

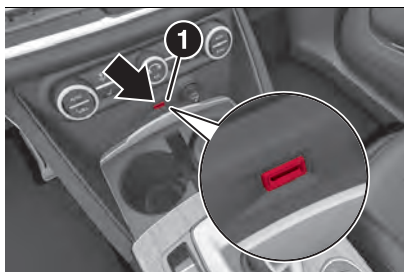

292

0402650981EM

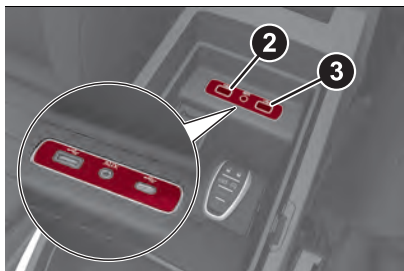

293

0402650993EM

USB socket (battery charger)

The glove compartment underneath the front armrest also contains a third USB socket (3) fig. 293 for use as a "battery charger" only.

AUX SOURCE

To activate AUX mode, insert an appropriate device in the AUX socket(1) fig. 294 on the car.

When a device is connected to that socket, the system starts reproducing the connected AUX source, if it is already playing.

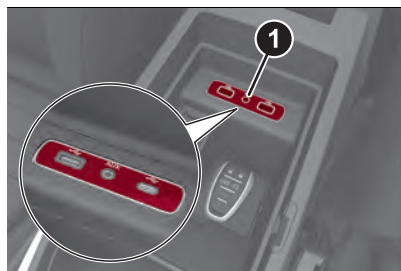

294

0402650982EM

CLIMATE CONTROL SYSTEM

The Connect system lets you interact with the automatic dual-zone climate control system to adjust the temperature inside the passenger compartment.

NOTE The climate control widget is only active via the touchscreen function.

The climate control widget in the Main Menu can display two different contents: "Air distribution" fig. 295 and "Comfort" (present only in case of heated electric seats and heated electric steering wheel).

Scroll up/down on the widget you can change the display.

Pressing the widget to activate the "Air Distribution" or "Comfort" screen.

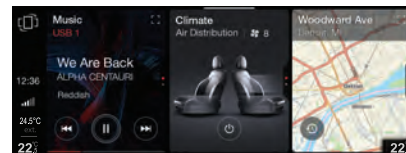

295

1212650970EM

On the climate control system widget is displayed a single graphic button (activated only using the touchscreen function) which, if pressed, allows you to turn off the automatic dial-zone climate control system and then turn it back on in its last active configuration before turning off.

"AIR DISTRIBUTION" SCREEN

The "Air Distribution" menu can be used to adjust the air temperature on driver and passenger side.

Graphic buttons are present on the screen for activating the same functions which can be selected using the buttons on the display of the automatic dual-zone climate control system located in the passenger compartment (see "Climate control system" chapter in the "Knowing your car" section).

"COMFORT" SCREEN

(where provided)

The "Comfort" screen can be used to adjust the heating level of driver and passenger seat and of the steering wheel.

PHONE MODE

NOTE Some "TELEPHONE" mode functions can be activated in addition to using the Rotary Pad and/or the touchscreen function, also using voice controls: for more information, see the "Phone voice controls" paragraph in the "Voice controls" chapter in this publication.

INDICATIONS ON THE DISPLAY



The "PHONE" mode widget appears on the main menu.

The widget display vary according to the following conditions:

- Paired mobile phone
- No paired mobile phone
- Phone call in progress
- Multiple phone call in progress
- Outgoing telephone call
- Phone conference in progress

Paired mobile phone

If you have already paired your mobile phone (see the following pages), the following three graphic buttons fig. 296 will appear on the "PHONE" widget:

-  Turn the microphone on/off during a phone call (1);
-  End call (2);
-  Transfer call to device (3).

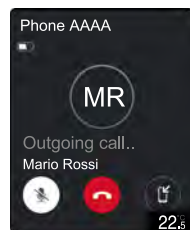

296

12126V2349EM

PAIRING A MOBILE PHONE

Pairing procedure

To pair the mobile phone, proceed as follows:

- activate the **Bluetooth**[®] function on the device;

- in the main menu, select the "SETTINGS" function by turning and pressing the Rotary Pad;
- select "Infotainment";
- select the **Bluetooth**[®] device;
- select "Add Device";
- search for the Connect system on the **Bluetooth**[®] audio device (during the pairing stage a screen will appear on the display showing the progress of the operation);
- select the device to be paired;
- when requested by the device, enter the PIN code shown on the system display or confirm the PIN displayed on the device;
- if the pairing procedure is completed successfully, a screen is displayed;
- the **Bluetooth**[®] function can also be activated by pressing the  "PHONE" or "MEDIA" functions, which can be selected from the main menu.

WARNING Perform the telephone pairing operation only while the car is stationary and in safe conditions. Only do this with the car stationary and in safe conditions. The feature is disabled when the car is moving faster than 5 km/h.

WARNING If the **Bluetooth**[®] connection between mobile phone and system is lost consult the mobile phone handbook.



ABC

MAKING A PHONE CALL

With the "PHONE" function on, you can make a call in the following ways:

- by selecting "Phone Book" on the display or "Recent Calls" and then selecting a contact from the suggested list;
- or
- by selecting "Dial" item on the display.

MAIN PHONE MENU

When a mobile phone is connected to the Connect system, various items (if available) will appear on the main menu fig. 297:

- network signal intensity;
- mobile phone battery charge;
- mobile phone name.

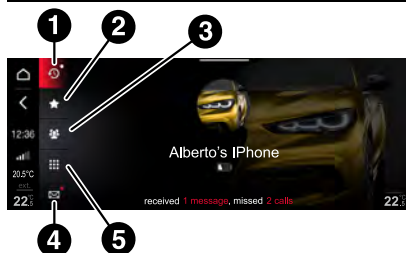

297

12126V2500EM

The other information shown on the display is fig. 297:

- 📞 "Recent calls" (1): press this graphic button to choose between "All Calls" and "Missed Calls".
- ★ "Favourites" (2): press this graphic button you can choose between "Edit favourites", "Add favourites", "Reorder favourites" and "Delete favourites".
- 📁 "Contacts" (3): press this graphic button on the display to show the list of all contacts registered on the phone. When you select a contact, the phone number and the photo (if any) linked to the contact appear on the right of the display.
- ✉️ "SMS" (4): press this graphic button to receive and send text messages (if supported by the device). The car must be stationary to read the messages. The listening function and the sending of default messages which can be customised by the driver is always possible. If an unread message is present, it is indicated by a dot next to the "SMS" graphic button (a maximum of 99 unread text messages can be present).
- ☎️ "Dial" (5): press this graphic button to show the "dial number" screen on the display which can be used to dial the telephone.

NAVIGATION MODE

(where provided)

LEGAL/ SAFETY NOTICE

When Connect is used for the first time, after resetting the default settings and having changed the language, the system will ask you to accept a safety/legal notice, warning you about the responsibilities involved in the product use while navigating.

NOTE Some "NAVIGATION" mode functions can be activated in addition to using the Rotary Pad and/or the touchscreen function, also using voice controls: for more information, see the "Navigation voice controls" paragraph in the "Voice controls" chapter in this publication.

NAVIGATION ACTIVATION

The "NAVIGATION" mode widget fig. 298 appears on the main menu.

NOTE The widget is only active using the touchscreen function.

The graphic button on the widget varies depending on whether navigation has been activated 📍 or is not activated 📍.

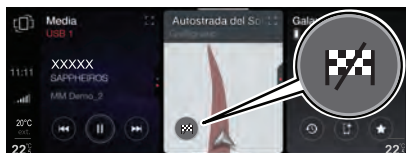

298

1212652010EM

SETTING A DESTINATION

The following data are required to set a destination:

- "City/Post code": enter the name or ZIP code of the city of the new destination arrival point;
- "Address": enter the street name of the new destination;
- "House Number": enter the house number of the new destination;
- "State" (where applicable/necessary): enter the name of the state of the new destination arrival point.
- "Start Navigation": select the desired destination using the right side of the display. This will provide access to the route planning screen to start navigating.

NOTE The data above can be entered in any order ("Free Text Search" function).

To set a new destination, select the graphic button  (using the

"touchscreen" function or by rotating the Rotary Pad): the graphic keyboard for entering the destination address will appear on the display and the list of "Destinations" will appear on the right side.

Management of voice recognition for entering navigation addresses

Pressing the button  on the right side of the steering wheel to start the voice recognition session and send the necessary commands to the Connect system to enter a navigation address.

You can enter addresses in two different ways:

- **One-shot:** Say "Navigate to <City, Address, House Number>" after pressing the button  on the right side of the steering wheel and starting the voice recognition session. The Connect system will be able to recognise the address you inserted or display a list of possible alternatives. Then follow the instructions provided by the Connect system to start route calculation.

- **Manual entry:** The Connect system will help you entry individual fields through a guided procedure, with the possibility of using the "City", "Address" and "House Number" voice commands. To activate this mode, press the button  located on the right side of the steering wheel and starting the voice recognition session,

send the first command to enter the city and continue following the instructions provided by the Connect system.

If a language change is made on the Connect system, using the dedicated menu in the "Settings" on the display, a pop-up screen will appear informing the driver of the limited availability of the voice recognition functions.

If you choose the English language on a car sold in Italy the following message will appear on the display of the Connect system: "When the vocal system is set to English you can input addresses in the United Kingdom, Ireland, Malta and Gibraltar. You can also insert all destinations manually."

WARNING The above message is located according to the country of destination of the vehicle. Only the countries shown on this pop-up screen will be available with voice recognition functions for address and destination selection. The available countries will change according to the language type selected by the driver.

NOTE The "one-shot" address entry mode will not be available if the driver chooses a language other than the one used in the country in which the car was marketed. In this case, in order to access the voice recognition functions and enter a valid address, i.e. recognisable by the Connect system, you will need to send to



ABC

the Connect system a voice command to change country in advance (for each use of the car). For example, if you choose English language on a car sold in Italy, you will need to use the voice command "Change country" to start the address entry procedure.

STOPPING NAVIGATION

After starting the navigation, it can be stopped at any moment by pressing the graphic button 

A dedicated message will appear on the display: select "Confirm" to confirm your choice and display the main navigation screen again, or "Cancel" to cancel the operation.

Tom Tom[®] ONLINE SERVICES

(where provided)

Tom Tom[®] "Online Services" (where provided) allow you to receive the following information and view on the Connect system display:

- "Live Traffic"/"Speed Cameras";
- "Send Destination to car";
- "Search for a point of interest (POI) online"
- "Last Mile Navigation".

NOTE Tom Tom[®] online services are available if Connected Services - Alfa Connect Services is activated and for the entire duration, plus any renewals, of the "My Navigation" package.

LIVE TRAFFIC / SPEED CAMERAS

(where provided)

With this service you can view the relevant information on the display of the Connect system:

- traffic (conditions updated in real-time);
- the presence of speed cameras (if any).

Live Traffic

With this service, you can monitor, the traffic conditions in real-time on the display of the Connect system. The information is displayed by means of special icons with the following colours fig. 299:

- GREEN:** Roads where the average traffic speed corresponds to the expected free flow speed;
- YELLOW:** Roads where the average speed is below the indicated road speed limit;
- RED:** Roads where the average speed is close to blocked traffic conditions;
- RED + DANGER SIGN:** Roads blocked, due to the presence of construction sites, accidents, etc.



299

12126S2300EM

Speed Cameras

(where provided)

With this service, you can see on the display the type (fixed or mobile) and location of the speed cameras.

The display shows a speed camera icon on the right-hand side.

If you press on the icon on the display you will see a screen with the following information about the speed cameras fig. 300:

- "Position" (e.g. "Both sides");

□ "Report Now."

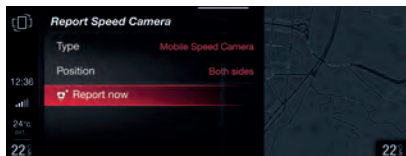

300

1212652132EM

Send Destination to car

Using this service, you can navigate to a second destination sent to Connect via your smartphone.

The new destination will appear in the lower area of the display; to start navigation, press the "Start Navigation" graphic button fig. 301:

□ **with destination NOT set:** the new destination will be displayed in the "Recent Destinations" menu;

□ **with destination set:** the new destination will be displayed in the "Manage Route" menu. To access the new destination press the "Add New Destination" graphic button.

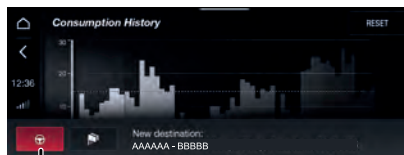

301

1212652135EM

SEARCH FOR A POINT OF INTEREST (POI) ONLINE

Using this service, you can enter a destination (by entering the name, address or a POI) and a list of POIs that match your search will appear on the display.

NOTE A subscription and authorisation is needed to use this service.

LAST MILE NAVIGATION

With this service you can transfer navigation from the Connect system to your smartphone.

When navigation is active, the Connect system will transfer navigation to your smartphone as follows:

□ **automatically** by activating the "Automatic sending Last Mile to mobile" option in the "Settings" menu;

□ **at the driver's request** by activating the "Send Last Mile Navigation" option

in the "Manage Route" menu or in the "Settings" menu;

□ **at the driver's request** if, during navigation, you touch a point on the Map and then select the "Send Last Mile Navigation" option on the pop-up menu that appears on the display.

Transferring Navigation to your smartphone

With active navigation, proceed as follows:

□ press the graphic button  ("Manage Route"): the "Manage Route" menu will appear on the display;

□ select the "Last Mile Navigation" item;

□ select the "Send Now Last Mile Navigation" item: the display will show a dedicated message indicating that the navigation will be transferred to the smartphone. Then press the "OK" graphic button to confirm the selection.

NOTE The final destination will be sent to the smartphone even if the car is not in a 1 kilometre (or 1 mile) radius from the final destination.

NOTE The transfer to the smartphone will take place even if you have not enabled the "Automatic sending Last Mile to mobile" feature in the "Settings" menu (the navigation will be transferred by selecting the "Send Last Mile Navigation" option).



ABC

SETTINGS

ACTIVATING THE SETTINGS MENU

The "Settings" menu can be activated by using the appropriate widget on the main menu fig. 302.

Indicatively, the following items are available in the menu:

- "Lights"
- "Units & Language"
- "Clock and Date"
- "Passive Safety"
- "Convenience & Comfort"
- "Doors & Locks"
- "Instrument panel"
- "Infotainment"
- "System"

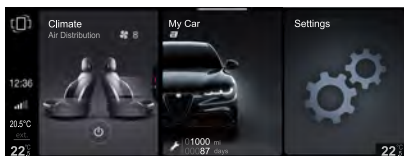

302

12126V2305EM

Lights

The following settings can be modified when this mode is selected:

- "Headlight Sensor"

- "Follow Me"
- "Cornering Lights"
- "Flash Lights with Lock"
- "Adaptive front lights" (AFS)
- "Daytime Running Lights"
- "Courtesy Lights"
- "Interior Ambient Lighting"
- "Restore Settings"

Units & Language

The following settings can be modified when this mode is selected:

- "Units"
- "Language"
- "Restore Settings"

Clock & date

The following settings can be modified when this mode is selected:

- "Sync with Gps Time"
- "Set Time"
- "Set Date"
- "Time Format"
- "Restore Clock and Date Settings"

Passive safety

The following settings can be modified when this mode is selected:

- "Passenger airbag": this is used to activate/deactivate the front passenger airbag function.

When the function is accessed: the system will detect the

activation/deactivation status of the airbags and confirm change of status. Press the Rotary Pad to continue. The airbag status is visible through the LEDs next to the status icon on the dashboard.

● **Passenger protection activated:** the ON LED switches on with a steady light.

● **Passenger protection deactivated:** the OFF LED switches on with a steady light.

"Auto Park Brake" (where provided): allows you to activate/deactivate the electric parking brake engagement when the engine is stopped.

"Brake service" (where provided): this can be used to activate ("Yes") or deactivate ("No") the procedure to effect brake system maintenance.

"Seat Belt Reminder": this is used to enable ("OK") or disable ("Cancel") the acoustic signal for the SBA (Seat Belt Alert) system.

"Automatic mirror folding" (where provided): This function activates/deactivates automatic folding of the mirrors when the doors are locked/unlocked. The default setting is "Off".

"Restore Settings": allows you to delete the previously settings from this menu and restore the default settings.

Convenience & Comfort

The following settings can be modified when this mode is selected:

- "Passive Entry": this allows you to activate ("On") or deactivate ("Off") the automatic door closing
- "Restore Settings": allows you to delete the previously settings from this menu and restore the default settings.

Doors & Locks

The following settings can be modified when this mode is selected:

- "Door lock in motion"
- "Unlock all doors on exit"
- "Door unlock on entry" (where provided)
- "Sound Horn with Remote Start" (where provided)
- "Sound Horn with lock" (where provided)
- "Auto Relock" (where provided)
- "Electric tailgate"
- "Automatic tailgate opening"
- "Convenience & Comfort"
- "Restore Settings"

Instrument panel

The following settings can be modified when this mode is selected:

- "Buzzer volume"
- "Trip B"

- "Show Phone Info"
- "Show Audio Info"
- "Show Nav Info"
- "Digital speed on all screens"
- "Consumption bar"
- "Performance pages"
- "Custom areas"
- "Restore Settings"

Infotainment

The following settings can be modified when this mode is selected:

- "Screen Off"
- "Display brightness"
- "Audio"
- "Home Page"
- "Bluetooth®"
- "Device Manager"
- "Entertainment"
- "Phone"
- "Projection mode"
- "Navigation" (where provided)
- "Performance Pages"
- "Android Auto"
- "Connected Services" (where provided)
- "Driver Assistance"

System

The following settings can be modified when this mode is selected:

- "Auto-On Radio"

- "Cam Delay"
- "Software Update"
- "Map Update"
- "Restore All Settings"

MAP UPDATE

(where provided)

To ensure optimal performance (where provided), the navigation system must be updated periodically.

For this, the **Mopar® Map Care** service offers a new map update every three months.

The updates can be downloaded from the maps.mopar.eu website and installed directly on the Connect system. All updates are free of charge for 3 years from the start of the warranty on the car.

The navigation system can also be updated at the Alfa Romeo Dealership.

NOTE The dealer may charge for updating the navigation system.

Map update procedure

Proceed as follows to update the navigation maps:

- start the engine;
- with the car stationary, insert the USB key, containing the updated maps, into one of the USB ports located on the central tunnel;



ABC

- ❑ select the "Update Map" option from within the "Map Update" function. The display will show a screen with the version and the duration of the whole procedure in minutes;
- ❑ select the "Update" function. The display will show a screen with the instructions to be followed and a request for confirmation;
- ❑ confirm to start the process.

During the update, the instructions to be followed will continue to be displayed together with the process progress. You can move the car during this phase.

PERFORMANCE

The "Performance pages" can be activated by using the appropriate widget on the main menu fig. 303.

The following information is shown on the main screen of the "Performance pages":

- ❑ "Technical gauges"
- ❑ "Consumption history"
- ❑ "Efficient Drive"
- ❑ "Engine torque"
- ❑ "Temperatures" (Quadrifoglio version only)
- ❑ "Drag Race" (Quadrifoglio version only)
- ❑ "Performance content" (where provided)

Turn the Rotary Pad to select the desired item and then press the Rotary Pad to

288

confirm the selection and access the menu or, using the touchscreen function, touch the display to select the desired item.

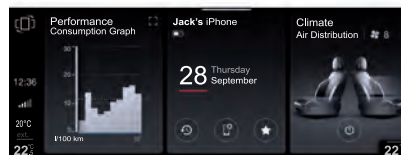

303

1212650400EM

CAR INFORMATION

The "Vehicle Information" function can be activated by using the appropriate widget on the Main Menu fig. 304.

The main screen shows information about:

- ❑ Service (scheduled servicing)
- ❑ TPMS (Tyre Pressure Monitoring System)
- ❑ Engine oil level
- ❑ AdBlue® level (only Diesel versions) (where provided)
- ❑ Alfa DNA™ system

To view the contents of one of the information on the display, press on the display (touchscreen function) or turn the Rotary Pad, select the desired item and

then press the Rotary Pad to confirm your selection.

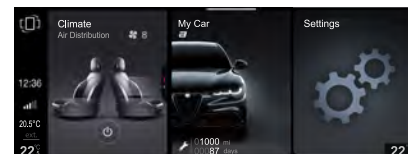

304

12126V2305EM

DRIVER ASSISTANCE

The "Driver Assistance" widget fig. 305 is located on the main menu of the Connect system.

The following menus are available in the "Driver Assistance" widget:

- ❑ "Safety"
- ❑ "Comfort"

Select the two menus by sliding on the widget upwards or downwards with a finger.

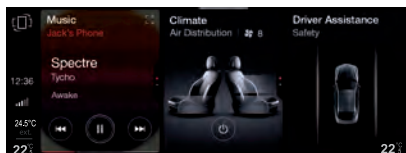

305

1212650431EM

"SAFETY" MENU

The "Safety" menu displays information on the following driver assistance systems:

- FCW (Forward Collision Warning) System
- LKA (Lane Keeping Assist) or LDW (Lane Departure Warning)
- ABSA (Active Blind Spot Assist) or BSM (Blind Spot Monitoring)
- DAA (Driver Attention Assist) System

Indications on the display

The driver assistance system status (activated or deactivated) is shown on the display by a graphic "shield" next to the outline of the car.

When ALL driver assistance systems are **ACTIVATED**, the following screen will appear on the display fig. 306.

When ALL driver assistance systems are **DEACTIVATED**, the following screen will appear on the display, fig. 305.

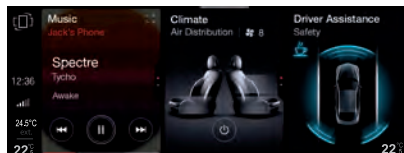

306

1212650438EM

"COMFORT" MENU

The "Comfort" submenu fig. 307 displays information on the following driver assistance systems:

- ISC (Intelligent Speed Control) System
- TSR (Traffic Sign Recognition) System
- Speed Limiter
- Park Sensors System
- Rear View Camera
- AHB (Automatic High Beam)

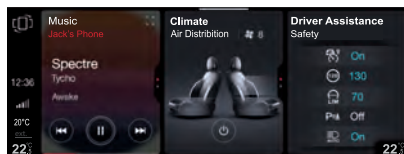

307

0707650709EM

Indications on the display

Each driver assistance system is represented by a corresponding icon on the display.

The status of the function is displayed next to the icon: "On" = system activated / "Off" = system deactivated.

Settings are possible on some systems (if activated), (e.g. the speed limit value can be adjusted on the Speed Limiter function).

SYSTEM SETTINGS

After viewing the "Driver Assistance" menu in full screen mode, a list of all settings that can be made for driver assistance systems will appear on the display.

The information shown on the display is as follows:

- system identification icon;
- system name;
- graphic button 1 fig. 308 for activating ("ON") and deactivating ("Off") the system;
- indication of the function status;
- graphic display area of the system;
- default system setting (modifiable by the driver).

The following active driver assistance/safety systems will not be available if you have selected the "Race" driving mode (where provided). In this



ABC

case, a dedicated pop-up screen will appear on the Connect system display.

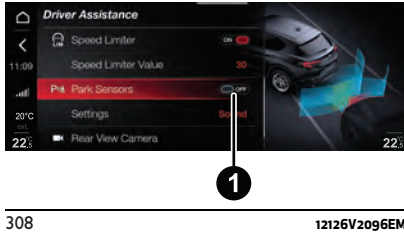

308

12126V2096EM

SYSTEM ACTIVATION/DEACTIVATION Using the touchscreen function

Proceed as follows:

- press the display to select the desired item;
- to activate the system, press the graphic button 1 fig. 308 rightwards: "ON" will appear on the display
- to deactivate the system, press the graphic button 1 fig. 308 leftwards: "OFF" will appear on the display.

Using the controls located on the central tunnel

Proceed as follows:

- turn the Rotary Pad and select the desired item;
- press on Rotary Pad to confirm the choice and activate the system: the selected item will be activated automatically. When the system is

activated, press the Rotary Pad to deactivate it.

Apple CarPlay and Android Auto

(where provided)

The Apple CarPlay and Android Auto applications allow you to use your smartphone in the car safely and intuitively.

To activate them, simply connect a compatible smartphone to the USB port and the contents of the phone will automatically appear on the display of the Connect system after having selected the default action the first time you connect an Android and/or an iOS device. Use the "Device Manager" menu to change the choice previously made.

To check the compatibility of your smartphone, see the indications on the websites: https://www.android.com/intl/it_it/auto/ and <http://www.apple.com/it/ios/carplay/>.

The first time a device is connected, a pop-up screen appears on the Connect system display, allowing you to choose which profile to use it with during subsequent connections. The possible options are: "Charge Only", "Media/iPod", "Projection mode". The options can be modified by using the "Device Manager" menu.

If your smartphone is properly connected to the car via the USB port, an additional

widget and its graphic icon will be displayed on the Connect System Main Menu on the left hand side of the status bar.

To use Apple CarPlay, connect your iPhone to the car using a MFI (made for iPhone) certified USB cable.

To use Android Auto, connect your smartphone to the car using a USB for Android phones having appropriate features. Using unsuitable cables may prevent correct system operation.

NOTE Interaction with the smartphone may be needed to enable Apple Carplay/Android Auto and some other functions. Complete the action on your device (smartphone) as needed.

APP CONFIGURATION (Apple CarPlay)

Apple CarPlay is compatible with the iPhone 5 or more recent models, with the iOS 7.1 operating system or later versions.

In order to use Siri in Apple CarPlay, you must activate the function from your smartphone settings.

To use Apple CarPlay, the smartphone must be connected to the car by means of a USB cable.

INTERACTION

After the configuration procedure, when you connect your smartphone to the USB port on the car, after displaying the pop-up screen and according to the last

setting made on the "Device Manager" menu, the application will automatically start on the Connect system.

The Rotary Pad can be used to select and confirm the available smartphone functions.

Multimedia contents on the smartphone can be accessed directly via "MEDIA" mode of Connect.

Interaction with voice controls

You can interact with the voice assistants of Apple CarPlay and Android Auto using the button  located on the right side of the steering wheel:

□ **long pressure** will activate interaction with the voice assistant of Apple (Siri) or Android (Google Assistant);

□ **short pressure** will initiate interaction with the native voice system. When the voice assistant of the phone is activated, the interface will be that of the associated telephone not that of the car. A short press will interrupt both the native voice session and that of Siri or Google Assistant.

WARNING If Apple CarPlay and Android Auto apps are present, Siri voice assistant (for Apple CarPlay) or Google Assistant (for Android Auto) will be activated. In this case you can use "Natural language" voice controls and not just the specific ones preset for the Connect system. The voice assistants

of Siri (for Apple CarPlay) or Google Assistant (for Android Auto) will only be activated by holding the button  pressed on the right side of the steering wheel.

Active Media or Phone mode

The following will be activated according to how you press the button  on the right side of the steering wheel:

□ a **short** press of the button  will activate the voice commands related to the Connect system;

□ a **long** press of the button  will activate the voice commands for the phone in "Projection" mode.

Active Tuner (Radio) or Navigation mode

Briefly pressing the  button on the right side of the steering wheel on the Connect system display to activate the voice control for "Tuner (Radio)" or "Navigation" mode, also when Apple CarPlay or Android Auto apps are activated.

NAVIGATION

With the Apple CarPlay and Android Auto applications, you can choose to use the navigation system on your smartphone.

The controls can be imparted directly on the Connect system.

The user can choose to change their selection at any time by accessing the

navigation system that they want to use and setting a new destination.

EXITING FROM THE Apple CarPlay AND Android Auto APPS

To end the Apple CarPlay or Android Auto session, physically disconnect the smartphone from the USB port on the car.

NOTE The date and time shown on Connect system display must match the actual date and time, even after disconnecting the battery. Adjust it from the "Settings" menu of Connect system. Any discrepancy between the date and time on the display and the actual date and time may be due to a malfunction in Apple CarPlay/Android Auto.



ABC

VOICE COMMANDS



WARNING Voice commands are not available for languages not supported by the system.

NOTE Voice controls activation is only possible with the ignition device at ON. Voice controls will not be active when the starter is in the OFF position and the Connect system is on.

NOTE If Apple CarPlay and Android Auto apps are present, Siri voice assistant (for Apple CarPlay) or Google Assistant (for Android Auto) will be activated. In this case you can use "Natural language" voice controls and not just the specific ones preset for the Connect system. The voice assistants of Siri (for Apple CarPlay) or Google Assistant (for Android Auto) will only be activated by holding the button  pressed on the right side of the steering wheel.

STARTING A VOICE SESSION

Briefly press the button  on the steering wheel once.

INTERRUPTING A VOICE SESSION

At any time during a voice session (dialogue), you can press and hold the button to stop and restart the voice session from scratch and impart a new command, regardless of the previous conversation.

For example, if the system is uttering a voice help message and recognises the desired command, it may be useful to stop the help by pressing the button  on the steering wheel and give the command, so you don't have to wait for the help messages to end.

DEACTIVATING A VOICE SESSION

With the voice session active, **briefly press** the button  on steering wheel.

The voice session will automatically close when a command has been recognised and no further actions are required by the driver.

A phone call will also interrupt the voice session, in order to allow you to answer and speak normally using the hands-free function.

RADIO AM/FM/DAB VOICE CONTROLS

The  button activates the following functions:

- Tune to station <XXX>
- Tune to station <XXX>
- Tune to frequency <XXX>
- Tune to frequency <XXX>
- Add to favourites
- Show available stations
- Show the list of available stations (where provided)
- Shows favourite stations (where provided)

- Show the list of favourite stations (where provided)
- FM
- AM (where provided)
- DAB (where provided)
- Radio controls ("Go to radio")

MEDIA VOICE COMMANDS

The  button activates the following functions:

- Play (or say View) Album
- Play (or say View) Artist
- Play (or say View) Composer
- Play (or say View) Genre
- Play (or say View) Playlists
- Play (or say View) Song
- Play (or say View) All
- Shuffle on
- Shuffle off
- Play Song (or Track)
- Play All (or say View All) Albums
- Play All (or say View All) Artists
- Play All (or say View All) Composers
- Play All (or say View All) Genres
- Play All (or say View All) Playlists
- Change to AUX
- Pass to USB 1
- Pass to USB 2
- Pass to USB 3
- Change to AUX
- Change Bluetooth®

NOTE These controls are valid on devices connected to the system via USB ports and not through the **Bluetooth®** system.

PHONE VOICE COMMANDS

The  button activates the following functions:

- Dial number <XXXXXXX>
- Call <XXXXXXX>
- Go (or say Change to phone)
- Phone commands
- Search contact
- Search
- Call back
- Show missed calls
- All Calls
- Show contacts
- View contacts
- Show all messages
- Send a message
- Send a message to
- Read last (or say Read the last) message

NOTE On some mobile phones, in order to have the text message voice reading function available, you need to enable the text messages option on the phone.

NAVIGATION COMMANDS

(where provided)

The  button activates the following functions:

- Go (or say Drive) Home

- Favourite <favourite name>
- Navigation commands
- Go (or say Change) to Navigation
- Set 2D map
- Set detailed 3D map
- Set overhead view
- Add destination
- Destination
- Stop Navigation
- Repeat instructions
- Show map
- Enter city
- Enter nation
- Enter country
- Enter street
- Enter house number
- Route preview
- Find the closest <point of interest>

NOTE Voice entry of addresses is only supported in the country in which you are located and provided that the system language matches the local language. For example, if the car is located in Italy, it will be possible to enter Italian addresses only if the system language is set to "Italian".



WARNING

221) *Voice controls must always be given in safe driving conditions, in compliance with the laws in force in the country where you are driving.*

CONNECTED SERVICES - ALFA CONNECT SERVICES

(for versions/markets where provided)



Alfa Connect Services enrich the experience of use of the car by connecting it to the network.

The services (where provided) allow you to receive timely assistance in case of need and emergency, to obtain information about the status of your car, its location, control it remotely and to improve the navigation experience (where provided) thanks to real-time updates.

You can access the Alfa Connect Services using a Alfa Connect mobile app for smartphone, smart watch, web portal or the Connect system of your car.

The availability of services is subject to a Alfa Connect Services subscription.

More information on Alfa Connect Services (applicability, availability, compatibility, packages and specifications)



ABC

can be found on the website:
<https://myalfaconnect.alfaromeo.com/>

GENERAL DISCLAIMER

Personal data & customization

□ FCA collects, processes and uses the personal data of the car in accordance with legal requirements. More information can be found in the general conditions of service and on data protection policies on the Alfa Romeo official website.

□ The Customer is solely responsible for using the services in the vehicle, even if by other people, and shall inform all users and occupants of the car about the services and the operations and limits of the system.

□ **If the SOS emergency service is activated, the call will be automatically routed to a private FCA Call Centre. We hereby specify that, whenever the SOS call is referred to the text, it is to be considered managed by private service providers.**

Operating prerequisites

□ Registration and activation are required to use some of the Alfa Connect Services. Go to the portal, accessible through the official Alfa Romeo website, or use the My Alfa Connect mobile application to do so and login on with your devices.

□ Alfa Connect Services is not available in all countries and is subject to limitations depending on Connect system type, location and duration of the services.

□ The full operation of the Alfa Connect Services, including SOS calls and roadside assistance calls (ASSIST), is subject to mobile network and GPS geolocation coverage, without which the proper provision of services is not guaranteed. Coverage may not be guaranteed in places such as tunnels, garages, multi-story parking garages, mountains.

□ The services may be unavailable in the event of mobile network overload or problems related to the car power source (e.g. low battery).

□ When using the services, customers shall keep their passwords secret for strictly personal use and not disclose them to third parties.

SERVICES

WARNING Some of the services listed below may not be available if the car is left with the engine off for more than 20 days. Start the engine to reactivate these services.

According on the equipment of the car and of the country, different services may be available for different durations. For further information about your car,

go to the personal page on the official Alfa Romeo website.

Some of the packages made available to the customer are:

□ **My Assistant:** Customer assistance and safety warning service, which includes:

- "SOS emergency call and ASSIST roadside assistance" (see the "In an emergency" section).

- "Vehicle condition report": information on the status and condition of the car, notifying potential maintenance needs to the customer via periodic e-mails. This service is provided on condition that the Customer has previously provided the FCA network with a valid e-mail address.

- "In-Vehicle Alerts (Basic)": to receive messages and/or alerts regarding recall campaigns or other important messages on the Connect system display. You can contact FCA Customer Service for further information regarding the messages received.

□ **My Car:** vehicle status monitoring service.

- "Driving Warnings": to set alerts when user-defined parameters such as speed, time and area are

exceeded, as well as the Valet Mode feature.

- "At-Home Digital Assistant": to run the main remote commands from a voice assistant as well as mobile apps and smartwatches.

❑ **My Remote:** this can be used to manage remote operations (switching on lights, door lock/unlock, find vehicle, etc.) from the mobile app and through compatible voice assistants. It also allows you to set up Driving Warnings with notifications, for example, when you exceed the set area or time.

❑ **My Navigation:** connected navigation service (subject to availability according to version/market).

❑ **My Wi-Fi:** Optional Wi-Fi Hotspot service. This service provides Internet access from the car to all devices with Wi-Fi connection (smartphones, tablets, laptops) (supported technologies: 3G – 4G). This creates a private Wi-Fi internet access point in the car. The function, available only with the ignition device in ON position or with the engine started allows the connection of up to eight devices simultaneously, but not the direct communication between devices. The quality of the service offered by the integrated Wi-Fi Hotspot depends on the coverage of the mobile operator's network.

NOTE The hotspot name and password can only be changed with the ignition device in the ON position.

❑ **My Alert:** optional service with app and web notifications in case of suspected theft attempts and assistance in case of theft.

You can enrich Alfa Connect Services experience by purchasing optional services for which a subscription is required.

The services can be subscribed to independently by the customer from the catalogue of services available for the car, directly on the <https://myalfaconnect.alfaromeo.com/> website.

NOTE The date and time shown on Connect system display must match the actual date and time, even after disconnecting the of the battery. Adjust it from the "Settings" menu of Connect system. Any discrepancy between the date and time on the display and the actual date and time may be due to on the malfunction in the Connected Services.

DEACTIVATION OF GEOLOCATION MODE

(for versions/markets where provided)

If you wish to deactivate geolocation mode, simply do so from the Connect

system fig. 309 (see the "Settings" menu of the Connect system for more details). When geolocation mode is deactivated some of the services on mobile apps and web that use the location of the car will not be available.

WARNING The  icon is shown at the bottom left of the Connect system display when the geolocation function is active (ON). When geolocation is on, the vehicle position is tracked to enable the functions that require it. When geolocation is off, the vehicle position is only tracked by the navigation, safety, insurance and driver assistance systems (where provided). See the Connect system "Settings" chapter to deactivate the function.

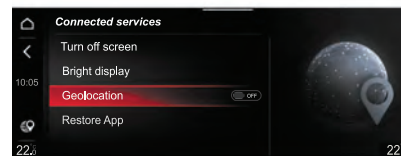

309

1212652094EM

UPDATING THE SYSTEM

Alfa Connect Services and the Connect system application software are updated remotely in order to provide the customer with newer software



ABC

versions that include new features or enhancements/enrichments of features already offered.

Updates are made at the discretion of FCA.

Some system updates will be managed automatically, others will be communicated to the Customer through messages on the Connect system display, allowing the customer to confirm or postpone the update.

The customer will be notified by the Connect system if the system is unavailable.

To obtain more information about services, features, specifications, availability and any updates please always refer to the content included in the official website of Alfa Romeo.

"AOTA" ("Updates Over The Air") OPERATION

(where provided)

This feature allows you to manually update the Connected Services - Alfa Connect Services present in the car.

If a Connected Services - Alfa Connect Services update is available, it will only be started when the ignition device is set to AVV.

If the ignition device is turned to STOP during the Connected Services - Alfa Connect Services update phase, the update will continue until this phase. The

update will be completed the next time the ignition device is set to AVV.

When update availability messages appear on the Connect system display:

if you do not accept the suggestion to update **and the update is mandatory**, the message will continue to appear on the display the next time the Connect system is turned on;

if you do not accept the update suggestion **and the update is not mandatory**, you can access the feature and see feedback on the Connect system display of the available update. Click on the graphic button on the display to continue the update.

IN-VEHICLE MESSAGING

(where provided)

This feature allows you to view pop-up messages on the Connect system display about:

- "Urgent Safety Recall";
- "Service Notification" ("Service Oil Soon" / "Low tyre pressure");
- "Subscription Expiring."

NOTE The pop-up messages can only be displayed when the ignition device is in the ON or AVV position. The messages will remain on the display for about 15 seconds and will disappear when the car starts to move.

Display of messages

Proceed as follows to display the messages:

- press the "Connected Services" widget shown on the display;
- select "In-Vehicle Messaging";
- a dedicated screen will appear on the display after selecting the desired item:

- press the "ASSIST" graphic button to activate a Roadside Assistance - ASSIST call, the message shown on the display will be marked as "read" and stored by the Connect system (for countries where the service is provided);
- press the "Delete" graphic button, a message will appear on the display to delete the message; select "Yes" if you want to delete the message or "No" if you do not want to delete it.

IN-VEHICLE ACTIVATION

(Connected Services – Alfa Connect Services activation)
(where provided)

This feature allows the driver to manually activate the Connected Services - Alfa Connect Services.

NOTE A manual "SOS Call" or a "Roadside Assistance Call - ASSIST" always has priority over the "In-Vehicle Activation" functions.

Manual function activation

Depending on the country in which the car is sold, the "Activate Services" function may be activated:

- by pressing the Connected Services widget;
- by selecting the "Activate Services" item shown on the display. This item will be shown on the display when the car is purchased only after receiving all the credentials from the Dealer (basic services will be active at the end of the production process). The "SOS Call" and "ASSIST Call" will be active when the process is complete.

In both cases, a screen with the following options will appear on the display after the operations described above:

- "Activate Now" (default option);
- "Learn More";
- "Postpone"

Entering your personal data

After pressing the "Activate Now" graphic button, the "Enter your data" screen will appear on the display fig. 310, in which the following options will appear:

- "First Name";
- "Last Name";
- "E-mail Address";
- "Confirm".

Fill in your name, surname and e-mail address.

NOTE The "Confirm" graphic button will only be active after you have entered a valid e-mail address.

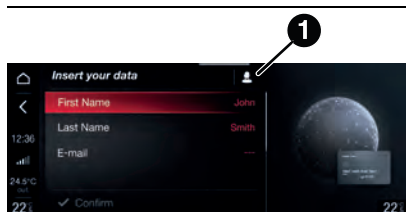

310

1212652119EM

On the screen there is also the graphic button 1 fig. 310. Pressing it to be put in contact with an operator who will help you complete the registration procedure.

Successful activation

If the activation is successful, you will receive a link (sent by the dealer) to click on at their e-mail address.

If the activation phase was not completed, a screen on which you can make two different choices will appear on the display:

- complete the activation procedure by clicking on the link;
- or

- activate using another account.

The "OK" and "CREATE NEW" graphic buttons will appear on the display:

- press the "OK" graphic button to end the activation procedure;
- press the "CREATE NEW" graphic button on the display to open a screen in which you can enter your personal data to receive the new link from the dealer.

DEACTIVATION OF ALFA CONNECT SERVICES

If you sell your car on which the Alfa Connect Services are still active, you will be responsible for logging off your profile from the services on the page on the official Alfa Romeo website, by contacting the Customer Care or by going to an Alfa Romeo dealership.

The customer is also responsible for informing the new owner of any services not yet expired associated with a new Alfa Connect Services account.



WARNING

222) Always follow the highway code of the country in which you are driving, and concentrate on the road. Always drive safely with your hands on the steering wheel. Only use Connect system functions when you are sure that it is safe to do so. The customer is liable for all risks associated with using the functions and



ABC

applications of the car. Failure to follow these rules may cause serious accidents and/or death.

WIRELESS CHARGING SYSTEM- WCPM (Wireless Charge Pad Module)

(where provided)

OPERATION

The wireless charger system is activated automatically when a mobile phone Qi® standard compatible is placed in the appropriate housing, fig. 311, if the mobile phone is compatible with the standard.

If the mobile phone is removed from the housing during the wireless charging phase, this will automatically be interrupted.



311

111650999EM

The wireless charger system enables charging when all doors are closed

properly and the engine has been started.

Interacting with the wireless charging system, positioning the mobile phone in the appropriate housing, the following messages are shown on the Connect system display (with specific icons and widgets), to inform the driver about the wireless charging system status:

- "Your phone is being charged", fig. 312 and fig. 313: is displayed when the mobile phone is positioned correctly in the wireless charging compartment and the system is activated correctly;
- "Phone fully charged", fig. 314: is displayed when the phone has completed charging its battery;
- "Object not allowed", fig. 315: is displayed when a phone that is not enabled for wireless charging or an object that is not permitted (e.g. the ignition key) is placed;
- "Unavailable system", fig. 315: appears when there is a malfunction in the wireless charger system.

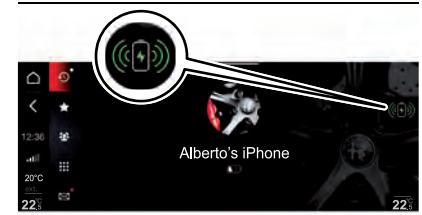

312

1212652085EM



313

1212652088EM



314

1212652086EM



315

12126S2o87EM

The driver can deactivate the display of messages relating to the operating status of the wireless charging system the relevant Connect system menu.

NOTE The use of multiple wireless functions on the smartphone at the same time (Apple CarPlay/Android Auto and wireless charging), as indicated by the smartphone manufacturers, could cause it to overheat, resulting in a limitation of the active functions or its turning off. In this case, it is recommended to connect the system using the USB socket.

OFFICIAL TYPE APPROVALS



RADIO DEVICES

All radio equipment provided with the car complies with the 2014/53/EU directive, UA.RED.TR, the French SAR Decree Law dated 15/11/2019 and the UKCA (UK Conformity Assessed) Certification dated 01/01/2023 in force in the United Kingdom.

For more information go to www.mopar.eu/owner or <http://aftersales.fiat.com/elum/>

RADIO FREQUENCY DEVICES

All radio frequency devices comply with the regulations in force in the countries in which they are sold.

For more information go to www.mopar.eu/owner or <http://aftersales.fiat.com/elum/>

CONNECT SYSTEM

The Connect system installed on the car complies with the 2014/53/EU directive, UA.RED.TR, the French SAR Decree Law dated 15/11/2019 and the UKCA (UK Conformity Assessed) Certification dated 01/01/2023 in force in the United Kingdom.



ABC

BORN TO BE TOGETHER



SELENIA





Oil change? The experts recommend Selenia

*The engine of your car is factory filled with **Selenia**. This is an engine oil range which satisfies the most advanced international specifications. Its superior characteristics allow **Selenia** to guarantee the highest performance and protection of your engine.*

The Selenia range includes a number of technologically advanced products:

Selenia Quadrifoglio

Selenia Quadrifoglio 5W-40 is a fully synthetic lubricant developed in collaboration with STELLANTIS that is tailor-made for passionate enthusiasts of driving, specially designed to improve the sporting performance and bring the best out of Alfa Romeo Quadrifoglio engines.

Selenia WR FORWARD 0W-20

Selenia WR FORWARD 0W-20 is a fully synthetic lubricant developed in collaboration with STELLANTIS specifically designed for latest generation passenger cars with diesel engines (Euro 6 Standards with UREA) and for high-performance engines in the luxury and sport cars segments.

Selenia DIGITEK PURE ENERGY

Selenia DIGITEK PURE ENERGY 0W-30 is a fully synthetic lubricant developed in collaboration with STELLANTIS formulated for modern passenger car petrol Euro 6 engines. Its particular viscosity grade and specific formulation are able to increase the fuel economy characteristics and consequently the reduction of CO₂ produced.

Selenia ECO2

Selenia ECO2 is a synthetic lubricant developed in collaboration with STELLANTIS for passenger car engines that is formulated to have low ash characteristics and provides very high energy saving fluid.

CONTENTS

A BS (Anti-Lock Brakes System)	94	Brakes brake fluid level	220	DTC (Drive Train Control) system	94
ABSA (Active Blind Spot Assist) System	98	BSM (Blind Spot Monitoring) system	98	Dusk sensor	30
Active Cruise Control	151	C arrying children safely	115	E lectric parking brake	137
Active safety systems	94	Changing a wheel	196	Electric seat heating	22
AdBlue® (UREA) additive for diesel emissions	183	Checking levels	220	Electric steering wheel heating	27
AdBlue® additive	178	Child lock	18	Electric sunroof	44
AFS function	30	Child restraint systems	115	Electric windows	43
Airbag Front airbags	129	Cigarette lighter / ashtray	48	Electronic key	13
Side bags	129	Climate control system	38	End of vehicle life	265
Airbag (SRS supplementary restraint system)	129	CO2 emissions	264	Engine	243
Alarm	17	Connected Services - Alfa Connect Services	293	engine coolant level	220
Alfa Active Suspension (AAS)	147	Controls on steering wheel Connect system	273	Engine compartment	220
Alfa DNA Pro system	144	Controls on tunnel Connect system	270	Engine compartment (washing)	238
Animations	30	Cruise Control	149	Engine Immobilizer (system)	16
Automatic dual-zone climate control system	40	Cup holder / can holder	48	Engine oil consumption	220
Automatic main beam headlights	30	D AA (Driver Attention Assist) System	109	level check	220
Automatic transmission	140	Daytime running lights (DRL)	30	Engine overheating	206
Automatic transmission gear lever release	206	Dimensions	251	Engine run-in	137
B attery	220	Dipped beam headlights	30	Environmental protection systems	51
Bodywork (cleaning and maintenance)	238	Direction indicators	30	EOBD system	91
Bonnet	45	Display	60	ESC (Electronic Stability Control) system	94
Boot ceiling lights	35	Door light	35	External lights	30
		Doors	18	F CW (Forward Collision Warning) System	98
		DPF (particulate filter)	51	Fire extinguisher	48
		Driving assistance systems	98	Fluids and lubricants	259
		Driving tips	183	Front ceiling light	35
				Front seats (adjustment)	22



Fuel consumption	264	Lifting the vehicle	235	Rims and tyres provided	246
Fuel cut-off system	206	Light switch	30	Rims and wheels	246
G lare Free	30	M ain beam headlights	30	S afe Hold	137
Glove compartment	48	O ccupant protection system	111	Saving fuel	183
Glove compartment light	35	Official type approvals	299	SBA (Seat Belt Alert) system	112
GPF (particulate filter)	51	P aintwork (cleaning and maintenance)	238	Scheduled servicing	210
H ands-free mode (tailgate)	46	Park Sensors system	168	Seat belts	111
HAS (Highway Assist) system	156	Parking lights	30	Seats	22
Hazard warning lights	190	Passive Entry (system)	18	Service Schedule	210
HDC (Hill Descent Control) system	94	PBA (Panic Brake Assist) system	94	Servicing procedures	229
Head restraints	26	Performance (top speed)	263	Side bag	129
Headlights (cleaning)	238	Power Lock (device)	18	Side lights	30
HSA (Hill Start Assist) system	94	Power sockets	48	Snow chains	235
I dentification data	242	Pre-tensioners	114	SOS call and ASSIST call	190
Ignition device	15	Load limiters	114	Speed Limiter	148
Instrument panel features	54	Prolonged car inactivity	237	SRS (supplementary restraint system)	129
Interior Ambient Lighting	35	R ain Sensor	36	Start & Stop Evo	147
Interior fittings	48	RCP function	98	Starting the engine	136
Interior lights	35	Rear Back-up Camera / Dynamic Gridlines	177	Starting with auxiliary battery	203
Interiors (cleaning)	239	Rear ceiling light	35	Starting with flat key battery	15
ISC (Intelligent Speed Control) System	167	Rear central armrest	48	Steering column lock	15
ISOFIX child restraint system (installation)	115	Rear seats	22	Steering wheel	27
J ack	196	Rear window wiper/washer	36	Sun visors	48
Jump starting	203	Rear-view mirrors	28	T ailgate	46
L ane Change	30	Recharging the battery	227	TC (Traction Control) system	94
Lane Departure Warning System	171	Refilling	255	The keys	13
Lane Keeping Assist system	174	Refuelling procedure	178	TJA (Traffic Jam Assist) System	161
		Refuelling the car	178	Towing a broken-down car	206
				Towing the car	207
				Towing trailers	186

TPMS (Tyre Pressure Monitoring System)	98
Transmission	245
Transporting animals	183
Transporting passengers	183
Trip Computer	66
TSR (Traffic Sign Recognition) System	165
Tyre Repair Kit	199
Tyres (inflation pressure)	246
V ehicle identification number	242
W arning lights and messages	68
WCPM (Wireless Charge Pad Module) system (wireless charging)	50
Weights and loads	253
Wheels	
(correct reading of the tyre)	246
correct reading of the rim code	246
Wheels and tyres	235
When parked	137
Window bag	129
Windows (cleaning)	238
Windscreen washer fluid	220
Windscreen wiper	36
replacing wiper blades	229
Windscreen wiper/washer	
Smart washing function	36



FCA Italy S.p.A. - MOPAR - Technical Service Operation
Via Adige 7, 10040 Rivalta di Torino (TO) - Italy
Print no. 603.93.810 - 04/2023 - 3 Edition

ALFA ROMEO GENUINE SPARE PARTS AND ACCESSORIES

PERFECT FOR YOUR VEHICLE, RIGHT DOWN TO THE SMALLEST DETAIL

The **Alfa Romeo Genuine Spare Parts and Accessories** follow the rigid component engineering and manufacturing specifications used in the assembly line to meet the technical specifications of your new Alfa Romeo and to enhance its style and performance. They undergo strict approval tests and **quality** controls to ensure they comply with **safety** and **environmental standards**.

All of the components on your new Alfa Romeo, from the smallest bulb to the most complex mechanical, electrical and electronic systems, are designed to work in harmony and guarantee you a comfortable and safe drive, in full respect for the environment. The Genuine Accessories fully enhance the style of your new vehicle.

Entrust **the experience and quality of Alfa Romeo Dealerships** to find the full range of Alfa Romeo Genuine Spare Parts and Accessories.

Find your nearest Dealership on www.alfaromeo.com





La meccanica delle emozioni